

SA2

**2021 PRIMARY 6 PRELIMINARY EXAMINATION**Name: _____ () Date: 18 August 2021

Class: Primary 6 ()

Time: 8.00 a.m. – 9.00 a.m.

Parent's Signature: _____

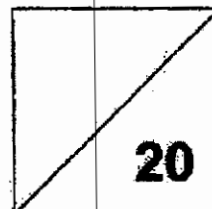
MATHEMATICS**PAPER 1****(BOOKLET A)****INSTRUCTIONS TO CANDIDATE**

1. Write your name, class and register number.
2. Do not turn over this page until you are told to do so.
3. Follow all instructions carefully.
4. Answer all questions.
5. Show your working clearly as marks are awarded for correct working.
6. You are NOT allowed to use a calculator.

Questions 1 to 10 carry 1 mark each. Questions 11 to 15 carry 2 marks each. For each question, four options are given. One of them is the correct answer. Make your choice (1, 2, 3 or 4). Shade the correct oval on the Optical Answer Sheet. [20 marks]

Q1. Bob took 130 seconds to run round a track.
He was 25 seconds faster than Pete.
How long did Pete take to run round the track?

- (1) 1 min 45 s
- (2) 1 min 55 s
- (3) 2 min 5 s
- (4) 2 min 35 s

Q2. 8 hundreds, 5 tenths and 6 thousandths is _____.

- (1) 800.056
- (2) 800.506
- (3) 800.560
- (4) 850.006

Q3. P is 5 times of Q. Q is thrice of R. What is the ratio of R to Q to P?

- (1) 1 : 15 : 3
- (2) 1 : 3 : 15
- (3) 3 : 1 : 15
- (4) 15 : 1 : 3

Q4. The number of visitors who went to a flower exhibition was 70 000 when rounded to the nearest hundred.

Which of the following shows a possible number of visitors?

- (1) 70 055
- (2) 70 051
- (3) 69 951
- (4) 69 949

Q5. Jenny faced south-east after turning 225° anti-clockwise. What direction was she facing at first?

- (1) North
- (2) South
- (3) South-east
- (4) North-east

Q6. The figure shows a semicircle of radius 21 cm.

Find the perimeter of the figure. (Take $\pi = \frac{22}{7}$)

- (1) 66 cm
- (2) 87 cm
- (3) 108 cm
- (4) 174 cm

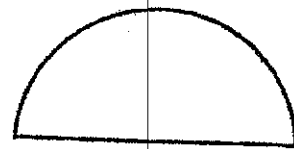

Q7. Which of the following is the same as 20 kg 8 g ?

- (1) 20.008 kg
- (2) 20.08 kg
- (3) 20.8 kg
- (4) 2.08 kg

Q8. Find the sum of all the factors of 64.

- (1) 62
- (2) 93
- (3) 127
- (4) 135

Q9. Which of the following statements about the angles in the figure are true?

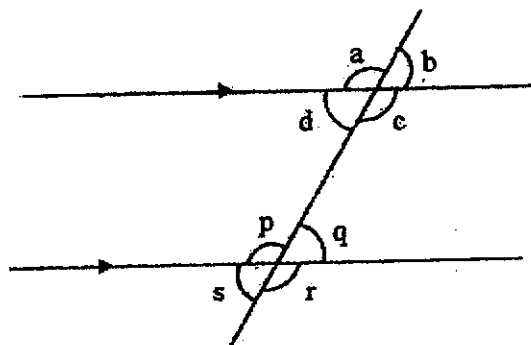

- A. $\angle a = \angle r$
- B. $\angle b = \angle s$
- C. $\angle s = \angle c$
- D. $\angle s = \angle q$

- (1) A and B only
- (2) A and D only
- (3) A, B and C only
- (4) A, B and D only

Q10. Study the following table carefully.

A	B	C	D
0	1	2	3
7	6	5	4
8	9	10	11
15	14	13	12

Which column will the number 71 appear in?

- (1) A
- (2) B
- (3) C
- (4) D

Q11. Guan Ming has 3 empty bottles J, K and R. He poured an equal amount of milk into each of them. As a result, 50% of J was filled with milk, 25% of K was filled with milk and 75% of R was filled with milk.

What is the ratio of the capacity of Bottle J to Bottle R to Bottle K?

- (1) 1 : 2 : 3
- (2) 2 : 3 : 1
- (3) 3 : 2 : 6
- (4) 3 : 6 : 2

- Q12. The figure is made up of a square and an oval.
 The ratio of the area of the square to the area of the oval is 2 : 3.
 The shaded area is $\frac{1}{6}$ the area of the oval. The shaded area is 36 cm².
 Find the area of the figure.

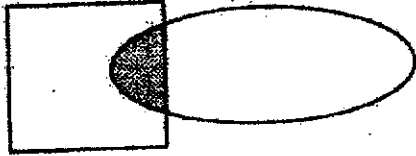

- (1) 144 cm²
 (2) 216 cm²
 (3) 324 cm²
 (4) 360 cm²
- Q13. The original price of a box of cookies was \$m. Auntie Loh bought a dozen such boxes of cookies. She was given a discount of 50 cents for every 2 boxes bought. How much did she pay for the boxes of cookies altogether?
- (1) \$(6m - 3)
 (2) \$(6m + 3)
 (3) \$(12m - 3)
 (4) \$(12m + 3)

Q14. Jonathan read 3 books in 2 hours. He spent 15 minutes longer to read the first book than the second book. He spent the same amount of time to read the last 2 books. How many minutes did he take to read the first book?

- (1) 30 min
- (2) 35 min
- (3) 45 min
- (4) 50 min

Q15. Which of the following fractions is closest to $\frac{3}{4}$?

- (1) $\frac{7}{8}$
- (2) $\frac{1}{2}$
- (3) $\frac{3}{5}$
- (4) $\frac{1}{4}$

- END OF BOOKLET A -

**2021 PRIMARY 6 PRELIMINARY EXAMINATION**Name: _____ () Date: 18 August 2021Class: Primary 6 () Time: 8.00 a.m. – 9.00 a.m.

Parent's Signature: _____

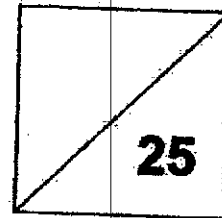
MATHEMATICS**PAPER 1****(BOOKLET B)****INSTRUCTIONS TO CANDIDATE**

1. Write your name, class and register number.
2. Do not turn over this page until you are told to do so.
3. Follow all instructions carefully.
4. Answer all questions.
5. Show your working clearly as marks are awarded for correct working.
6. You are NOT allowed to use a calculator.

Questions 16 to 20 carry 1 mark each. Write your answers in the spaces provided.
For questions which require units, give your answers in the units stated. [5 marks]

Q16. Find the value of $49.14 \div 7$

Ans : _____

Q17. Express 0.5% as a fraction in the simplest form.

Ans : _____

Q18. The table below shows the number of books read by each pupil in a class of 28 pupils. One of the numbers in the table is covered by an ink stain.

Number of books read by each pupil		12
Number of pupils	8	20

The average number of books read by the pupils in the class is 10.
What is the number covered by the ink stain?

Ans: _____

Q19. A bottle contains 1.05 litres of water. Wendy pours 300 ml of water from it into a cup. How much water is left in the bottle?

Ans: _____ ml

Q20. In the square grid,

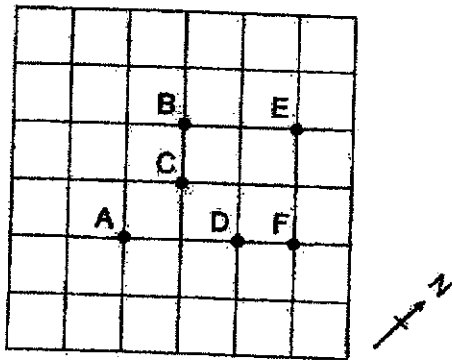

(a) Point _____ is West of Point D.

(b) Point _____ is South-West of Point E.

Ans: (a) Point _____

(b) Point _____

Questions 21 to 30 carry 2 marks each. Show your working clearly in the space provided for each question and write your answers in the spaces provided. For questions which require units, give your answers in the units stated. (20 marks)

Q21. What is the missing number in the box?

$$\square + 2 \times 30 + (200 - 90) = 320$$

Ans: _____

Q22. $\frac{3}{5}$ of Christy's spending is equal to $\frac{7}{12}$ of Kelvin's spending.

What is the ratio of Kelvin's spending to Christy's spending?

Ans: _____

Q23. The figure below shows 2 semicircles. EG is 34 cm.

Find the perimeter of the figure. Leave your answer in terms of π .

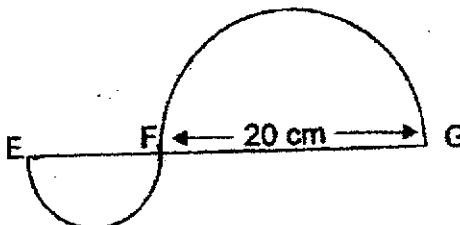

Ans: _____ cm

Q24. The bar graph below shows the number of cakes produced by ABC Bakery in 5 months.

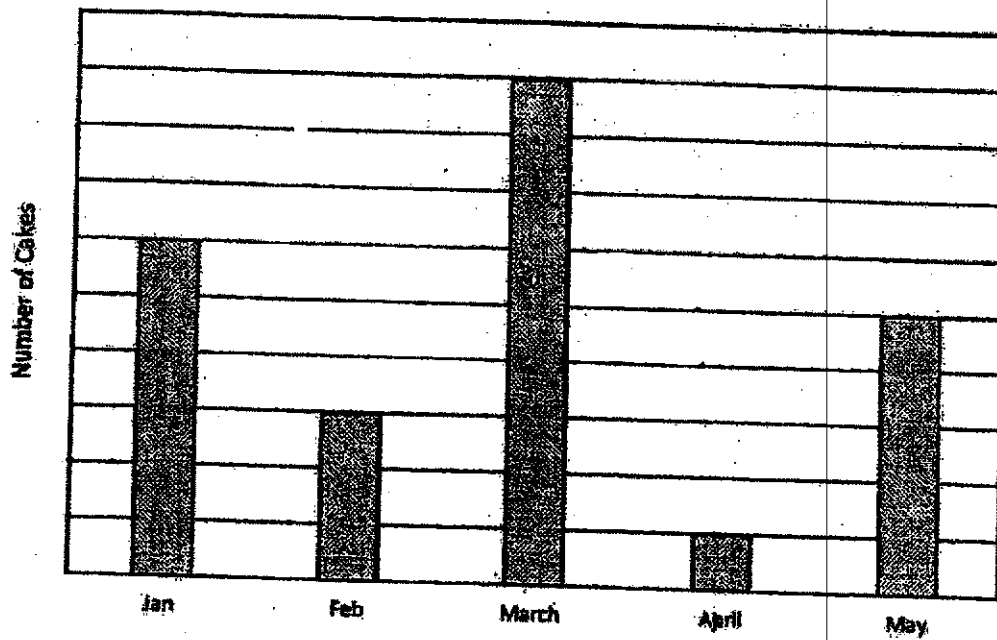

In which month did the bakery produce $\frac{1}{4}$ of the total number of cakes produced in the 5 months?

Ans: _____

- Q25. Ming Lei drew three rectangles to form a figure. The areas of the rectangles were in the ratio 3 : 5 : 18. She then shaded some parts of the figure as shown. What fraction of the figure was shaded?
Express your answer in the simplest term.

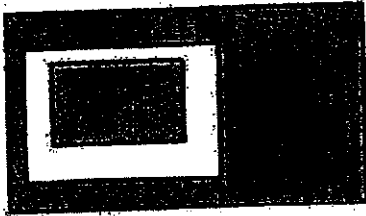

Ans: _____

- Q26. 16 students were assigned to line up in a row from one end to the other end of a corridor to welcome parents to a school event. They had to stand at an equal spacing of 1.2 m apart.

On the day of the event, 5 of the students did not turn up. As a result, the remaining students had to line up from one end to the other end of the corridor at a new equal spacing.

What was the new spacing between 2 students?

Ans: _____ cm

- Q27.** A school bus can carry 24 adults or 32 children.
There are already 9 adults and 11 children on the bus.
How many more children can the bus carry?

Ans: _____

- Q28.** The following figure, *not drawn to scale*, is made up of a square, a rectangle and 2 identical triangles. AB and CD are straight lines.
Find the area of the figure.

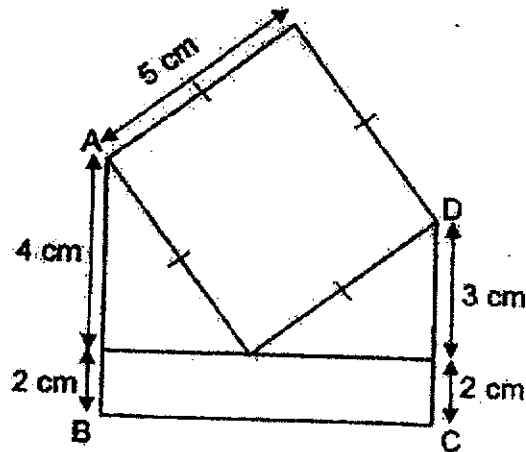

Ans: _____ cm^2

Q29. Mr Tao saved 40% of his salary. When he increased his savings by 20%, he would have \$400 less to spend. How much was his salary?

Ans: \$ _____

Q30. Nora bought a packet of milk for \$0.85 and a banana muffin for \$1.40. She gave the cashier a \$5 note. She received her change all in coins. What is the least number of coins Nora would have received?

Ans: _____

- END OF BOOKLET B -



2021 PRIMARY 6 PRELIMINARY EXAMINATION

Name: _____ () Date: 18 August 2021

Class: Primary 6 ()

Time: 10.30 a.m. - 12.00 p.m.

Parent's Signature: _____

MATHEMATICS PAPER 2

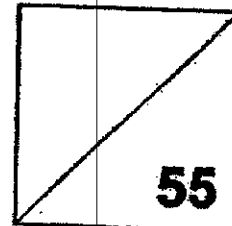

INSTRUCTIONS TO CANDIDATES

1. Write your name, class and register number.
2. Do not turn over this page until you are told to do so.
3. Follow all instructions carefully.
4. Answer all questions.
5. Show your working clearly as marks are awarded for correct working.
6. You are allowed to use a calculator.

Questions 1 to 5 carry 2 marks each. Show your working clearly in the space provided for each question and write your answers in the spaces provided. For questions which require units, give your answers in the units stated. (10 marks)

1. Peter and James were usually given \$58 altogether for their weekly pocket money. As James needed money for new books next week, he asked for \$19 more. As a result, he would have $\frac{3}{4}$ as much money as Peter. How much was Peter's pocket money?

Ans: \$ _____

2. There were 34 red candies and 18 yellow candies in a jar. An equal number of red and yellow candies were removed from the jar. The ratio of the number of red candies to the number of yellow candies became 5 : 1. How many red candies were there in the end?

Ans: _____

3. Melissa is able to type 45 words per minute. She was tasked to type a document of 30 pages. Given that the average number of words on each page was 450 words, how many hours will she take to complete her task?

Ans: _____ h

-
4. Mr Wong is 46 years old now. His son is n years younger than him. Find, in terms of n , their total age in 3 years' time.

Ans: _____ years

5. In the figure below, ABC is an equilateral triangle with $AB = BC = CA$. Given $\angle ABD = 21^\circ$ and $\angle ADE = 44^\circ$, find $\angle BDE$.

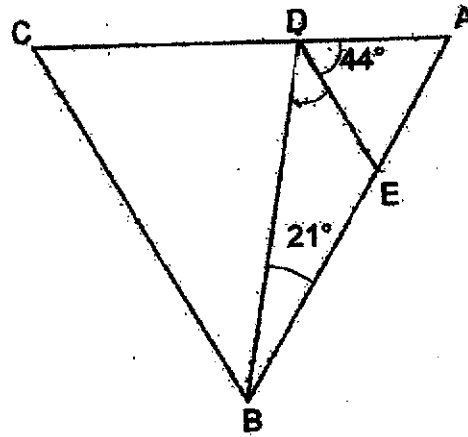

Ans: _____

For questions 6 to 17, show your working clearly in the space provided for each question and write your answers in the spaces provided.
The number of marks available is shown in brackets [] at the end of each question or part-question.
[45 marks]

6. In the figure below, not drawn to scale, $ABCF$ is a rhombus and BCD is an isosceles triangle. $\angle ABE = 39^\circ$ and $\angle BCF = 128^\circ$.

(a) Find $\angle AFC$.

(b) Find $\angle FCD$.

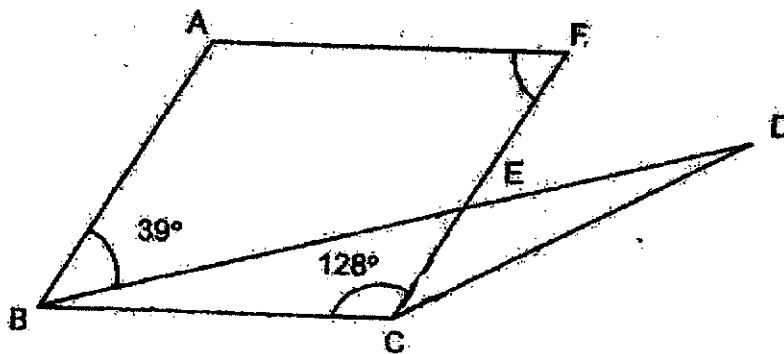

Ans: (a) $\angle AFC =$ _____ [1]

(b) $\angle FCD =$ _____ [2]

7. The bar graph shows the number of cars owned by families in a neighbourhood.

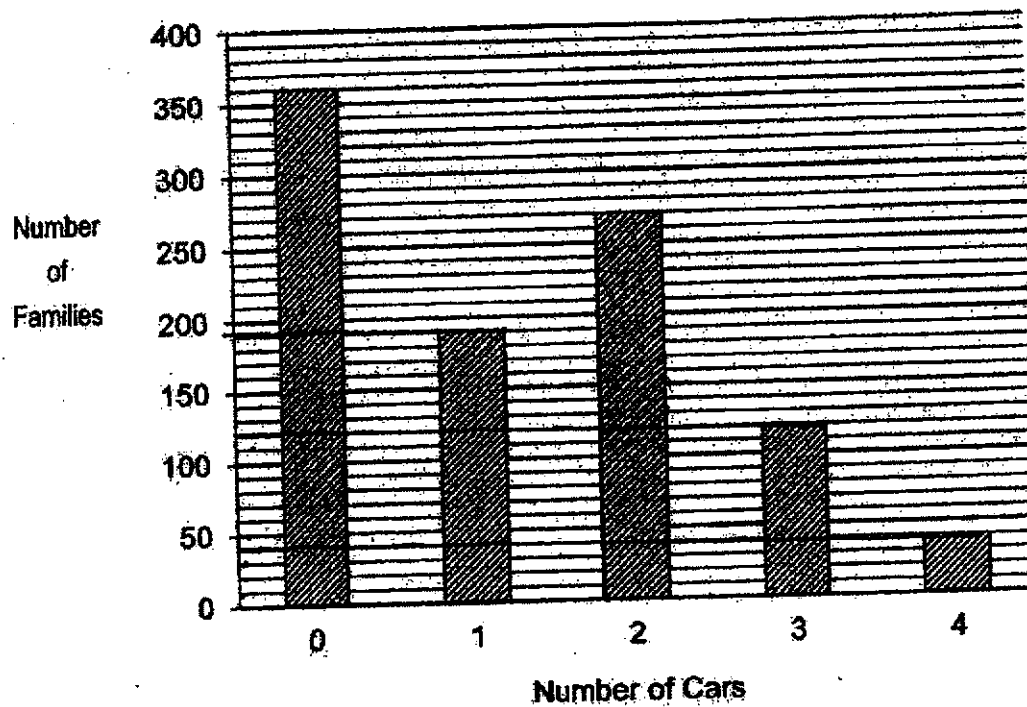

- (a) How many families have less than 2 cars?
- (b) From the families who own at least 3 cars, what fraction of them have 4 cars? Give your answer in the simplest form.

Ans: (a) _____ [1]

(b) _____ [2]

8. In a school, 60% of the boys and 40% of the girls wear spectacles. The number of boys and girls who wear spectacles is the same. For the boys and girls who do not wear spectacles, the number of girls more outnumbered the number of boys by 50. How many girls are there?

Ans: _____ [3]

9. In the diagram below, PQR is an equilateral triangle and PTR is an isosceles triangle. QS is a straight line. $QS \perp PR$ and $\angle QTR = 121^\circ$.

Find

(a) $\angle TRP$

(b) $\angle QPT$

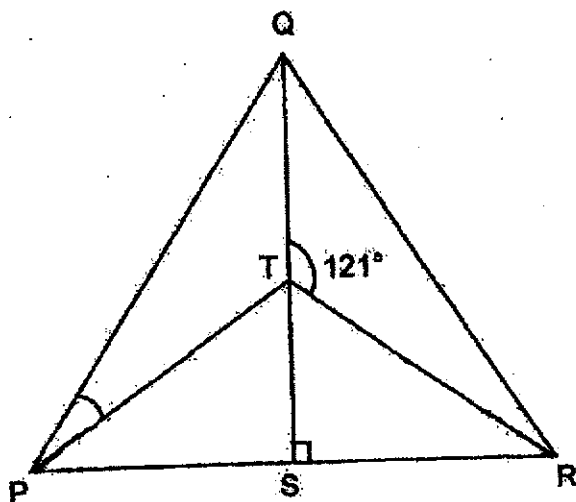

Ans: (a) $\angle TRP =$ _____ [2]

(b) $\angle QPT =$ _____ [2]

10. At first, the number of strawberries that Roger and Darren had was in the ratio 5 : 7 respectively. Roger gave $\frac{1}{5}$ of his strawberries to his sister and Darren ate 35 of his strawberries. In the end, Roger had twice as many strawberries as Darren. Find the number of strawberries Darren had at first.

Ans: _____ [3]

11. In his demonstration on the art of tea making, John first poured some tea from a pot into an empty cup.

The amount of tea in the cup is $\frac{1}{4}$ of the amount of tea left in the pot.

For the second step, he poured 20 ml of milk into the cup.

Finally, he poured 50 ml of tea from the pot into the cup.

The final amount of liquids in the cup was $\frac{1}{3}$ of that left in the pot.

- (a) Find the total amount of milk and tea added from the second and final steps.
- (b) Find the original amount of tea in the pot.

Ans: (a) _____ [1]

(b) _____ [3]

12. Triangle T is drawn by joining dots on the square grid below.

(a) Draw a right-angled triangle with the same area as Triangle T.
Label the triangle R.

[1]

(b) Draw a parallelogram with twice the perimeter as Triangle T.
Label the parallelogram P.

[2]

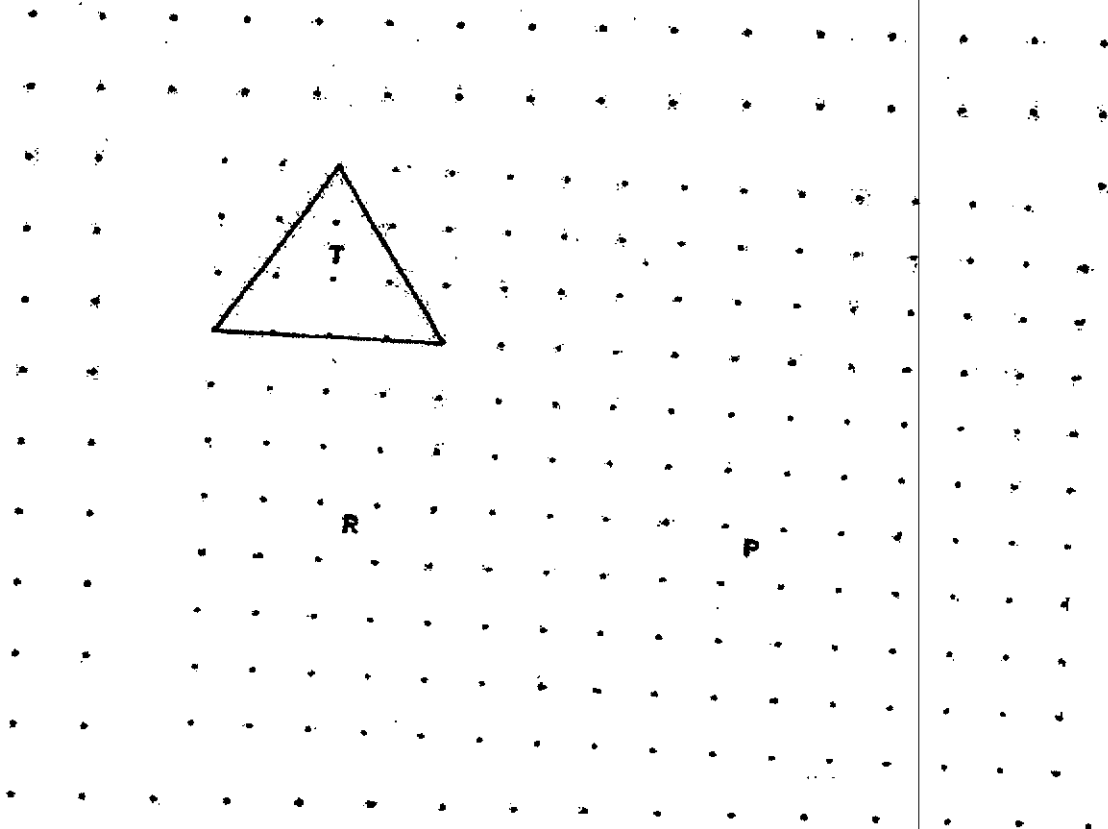

(c)

[1]

The following statement is either true, false or not possible to tell. Put a ✓ in the correct column.	True	False	Not possible to tell
The area of P is twice the area of T.			

13. Study the following figure.

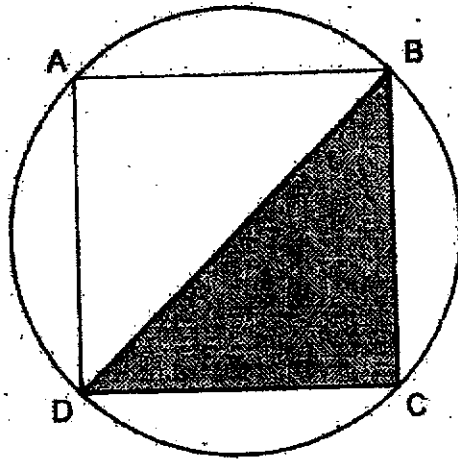

ABCD is a square and the area of the circle is 200.96 cm^2 . (Take $\pi = 3.14$)

- Find the radius of the circle.
- Find the length of the arc AB.
- Find the area of the shaded triangle BCD.

Ans: (a) _____ [2]

(b) _____ [1]

(c) _____ [1]

14. The line graph below shows the number of residents in Town A and Town B who are involved in a recycling project from Year 2000 to Year 2020.

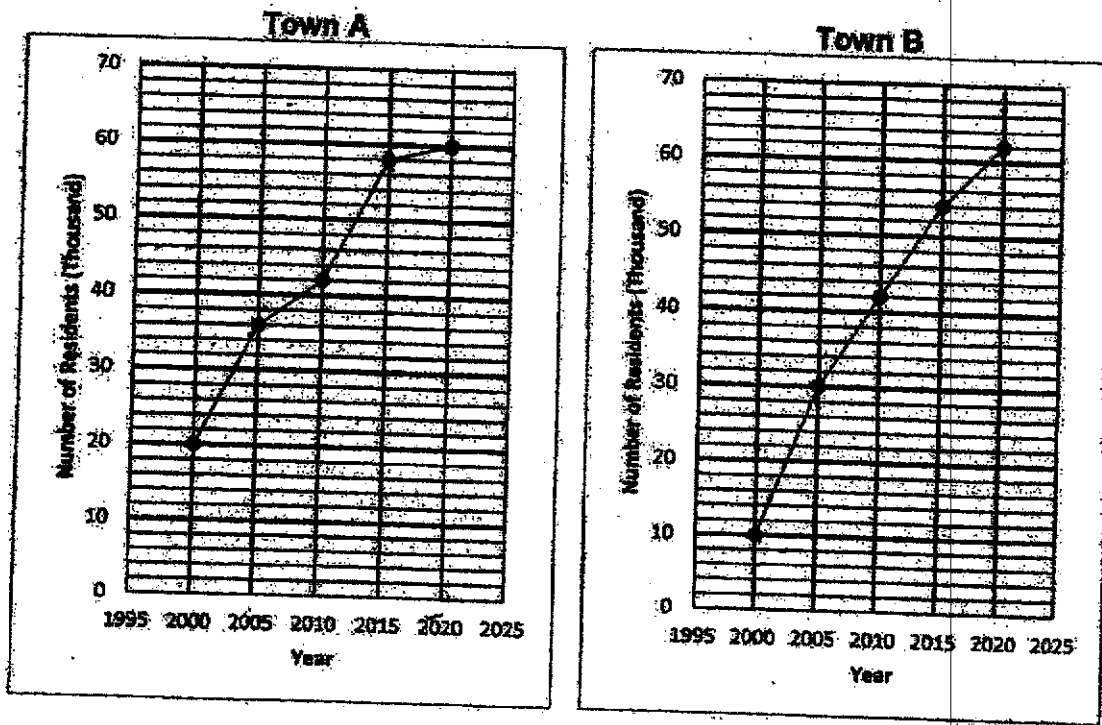

- (a) In which year(s), were there more residents involved in the recycling project in Town B than in Town A?
- (b) For Year 2025, the number of residents in Town A who are to be involved in the recycling project are expected to increase by 25%. Find the number of residents in Town A who are expected to be involved in Year 2025.
- (c) What is the percentage increase in the number of residents in Town B who are involved in the recycling project from Year 2000 to Year 2020?

Ans: (a) _____ [1]
 (b) _____ [1]
 (c) _____ [2]

15. The total age of workers in a restaurant is 256 years.
The average age of the oldest worker and youngest worker is 41 years.
The average age of the rest of the workers is 29 years.
Find the total number of workers in the restaurant.

Ans: _____ [3]

16. Aaron uses circles and triangles to form figures that follow a pattern. The first four figures are shown below.



Figure 1



Figure 2

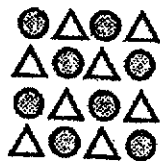

Figure 3

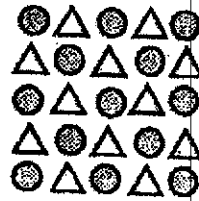

Figure 4

(a) Complete the table for Figure 5 and Figure 20. [2]

Figure Number	1	2	3	4	5	...	20
Number of triangles	2	4	8	12			
Number of circles	2	5	8	13			221
Total number of triangles and circles	4	9	16	25	36		

- (b) Find the Figure Number of the pattern that has a total of 729 triangles and circles.
- (c) Find the Figure Number of the pattern with 840 triangles.

Ans: (b) Figure _____ [1]

(c) Figure _____ [2]

17. The following solid figure was formed using ten 2-cm cubes.
The exterior of the solid figure (including the base of the solid) was painted.
- (a) Find the total painted surface area of the solid figure.
- (b) If the 2-cm cubes were taken apart, how many faces of the cubes were *not* painted?
- (c) More cubes were added to form a big cube.
What is the least number of 2-cm cubes added?

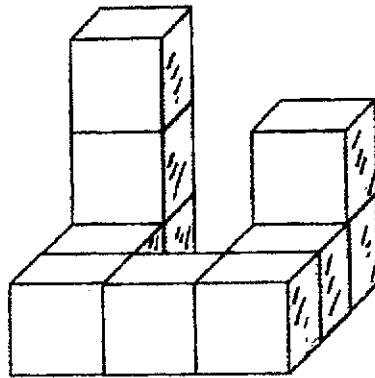

Ans: (a) _____ [2]

(b) _____ [1]

(c) _____ [2]

End of Paper 2

ANSWER KEY

YEAR : 2021
LEVEL : PRIMARY 6
SCHOOL : TAO NAN
SUBJECT : MATHEMATICS
TERM : PRELIMINARY

BOOKLET A (PAPER 1)



Q1	4	Q2	2	Q3	2	Q4	3	Q5	1
Q6	3	Q7	1	Q8	3	Q9	4	Q10	1
Q11	3	Q12	3	Q13	3	Q14	4	Q15	1

BOOKLET B (PAPER 1)

Q16	7.02	Q17	$\frac{1}{200}$
Q18	$28 \times 10 = 280$ $280 - 12 = 268$ $20 \times 12 = 240$ $280 - 240 = 40$ $40 \div 8 = 5$	Q19	$1.05\text{L} = 1050\text{ml}$ $1050\text{ml} - 300\text{ml} = 750\text{ml}$
Q20	a) C b) B	Q21	$210 \div 30 = 7$ $7 \times 2 = 14$
Q22	Kelvin : Christy 36 : 35	Q23	$\frac{1}{2} \times 2 \times \pi \times 10 = 10\pi$ $\frac{1}{2} \times 2 \times \pi \times 7 = 7\pi$ $10\pi + 7\pi + 20 + 14$ $= (17\pi + 34)\text{cm}$
Q24	$6 + 3 + 9 + 1 + 5 = 24$ $\frac{1}{4} \times 24 = 6$ ANS : January	Q25	$13 + 3 + 2 = 18$ $\frac{16}{18} = \frac{8}{9}$
Q26	$16 - 1 = 15$ $15 \times 120 = 1800$ $5 \times 120 = 600$ $1800 \div 10 = 180\text{ cm}$	Q27	$12 + 11 = 23$ $32 - 23 = 9$
Q28	$5 \times 5 = 25$ $2 \times \frac{1}{2} \times 4 \times 3 = 12$ $2 \times 7 = 14$ $25 + 12 + 14 = 51\text{ cm}^2$	Q29	$100\% + 20\% = 120\%$ $0.4\text{ units} = 400$ $5\text{ units} = 1000 \times 5 = 5000$

Q30	$0.85 + 1.40 = 2.25$ $5 - 2.25 = 2.75$ ANS : 5		
-----	---	--	--

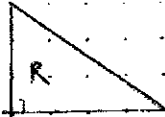
PAPER 2

Q1	\$44	Q2	$34 - 18 = 16$ $17 \text{ units} = 34$ $1 \text{ unit} = 34 \div 17 = 2$ $10 \text{ units} = 2 \times 10 = 20$
Q3	$450 \times 30 = 13500$ $13500 \div 45 = 300$ $300 \text{ min} = 5 \text{ h}$	Q4	$46 + 3 = 49$ $46 - n + 3 = 49 - n$ $49 + 49 - n = (98 - n) \text{ years}$
Q5	$\angle ABC = \angle ACB = \angle CAB$ $= 180^\circ \div 3 = 60^\circ$ $\angle CBD = 60^\circ - 21^\circ = 39^\circ$ $\angle CDB = 180^\circ - 60^\circ - 39^\circ$ $= 81^\circ$ $\angle BDE = 180^\circ - 44^\circ - 81^\circ$ $= 55^\circ$	Q6	a) $\angle DBC = 180^\circ - 39^\circ - 128^\circ$ $= 13^\circ$ $\angle AFC = 39^\circ + 13^\circ = 52^\circ$ b) $\angle FCD = 180^\circ - 13^\circ - 13^\circ - 128^\circ = 26^\circ$
Q7	a) $360 + 190 = 550$ b) $120 + 40 = 160$ $\frac{40}{160} = \frac{1}{4}$	Q8	$9 - 4 = 5$ $50 \div 5 = 10$ $6 + 9 = 15$ $15 \times 10 = 150$
Q9	a) $\angle RTS = 180^\circ - 121^\circ = 59^\circ$ $\angle TRP = 180^\circ - 90^\circ - 59^\circ = 31^\circ$ $\angle QPR = 180^\circ \div 3 = 60^\circ$ b) $\angle QPT = 60^\circ - 31^\circ = 29^\circ$	Q10	$5 \text{ units} - 1 \text{ unit} = 2 \text{ parts}$ $7 \text{ units} - 35 = 1 \text{ part}$ $14 \text{ units} - 70 = 2 \text{ parts}$ $4 \text{ units} = 2 \text{ parts}$ $4 \text{ units} = 14 \text{ units} - 70$ $70 = 14 \text{ units} - 4 \text{ units}$ $70 = 10 \text{ units}$ $10 \text{ units} = 70$ $1 \text{ unit} = 70 \div 10 = 7$ $7 \text{ units} = 7 \times 7 = 49$
Q11	a) $20 + 50 = 70$ b) $1u + 70 = 1p$ $4u - 50 = 3p$ $3u + 210 = 3p$ $3u + 210 = 4u - 50$ $210 + 50 = 1u$ $1u = 260$	Q12	a)  b)  c) False

	$5u = 260 \times 5 = 1300\text{ml}$																														
Q13	<p>a) $200.96 \div 3.14 = 64$ $\sqrt{64} = 8\text{cm}$</p> <p>b) $8 \times 2 = 16$ $\frac{1}{4} \times 2 \times 3.14 \times 8 = 12.56\text{ cm}$</p> <p>c) $\frac{1}{2} \times 8 \times 16 = 64\text{ cm}^2$</p>	Q14	<p>a) 2020</p> <p>b) $60000 \times 125\% = 75000$</p> <p>c) $62 - 10 = 52$ $\frac{52}{10} \times 100\% = 520\%$</p>																												
Q15	<p>Total age of oldest & youngest work = $41 \times 2 = 82$</p> <p>Age of remaining workers = $256 - 82 = 174$</p> <p>$174 \div 29 = 6$</p> <p>$6 + 2 = 8$</p>	Q16	<p>a)</p> <table border="1" data-bbox="861 716 1364 1265"> <thead> <tr> <th>Figure</th> <th>1</th> <th>2</th> <th>3</th> <th>4</th> <th>5</th> <th>20</th> </tr> </thead> <tbody> <tr> <td>Number of triangles</td> <td>2</td> <td>4</td> <td>8</td> <td>12</td> <td>18</td> <td>220</td> </tr> <tr> <td>Number of circles</td> <td>2</td> <td>5</td> <td>8</td> <td>13</td> <td>18</td> <td>221</td> </tr> <tr> <td>Total number of triangles and circles</td> <td>4</td> <td>9</td> <td>16</td> <td>25</td> <td>36</td> <td>441</td> </tr> </tbody> </table> <p>b) $\sqrt{729} = 27$ $27 - 1 = 26$</p> <p>c) $840 + 841 = 1681$ $\sqrt{1681} = 41$ $41 - 1 = 40$</p>	Figure	1	2	3	4	5	20	Number of triangles	2	4	8	12	18	220	Number of circles	2	5	8	13	18	221	Total number of triangles and circles	4	9	16	25	36	441
Figure	1	2	3	4	5	20																									
Number of triangles	2	4	8	12	18	220																									
Number of circles	2	5	8	13	18	221																									
Total number of triangles and circles	4	9	16	25	36	441																									
Q17	<p>a) $5 + 4 + 4 + 4 + 4 + 4 + 4 + 4 + 4 + 5 = 42$ $42 \times 2 \times 2 = 168\text{ cm}^2$</p> <p>b) $6 - 5 = 1$ $1 \times 2 = 2$ $6 - 4 = 2$ $2 \times 8 = 16$ $16 + 2 = 18$</p> <p>c) $3 \times 3 \times 3 = 27$ $27 - 10 = 17$</p>																														

3
END

