

SA2



**ROSYTH SCHOOL
2021 PRELIMINARY EXAMINATION
MATHEMATICS
PRIMARY 6
PAPER 1**

Name: _____ Register No. _____

Class: Pr 6 - _____ Group: _____

Date: 24 August 2021 Parent's Signature: _____

Total Time for Booklets A and B : 1 hour

BOOKLET A

Instructions to Pupils:

1. Do not open this booklet until you are told to do so.
2. Follow all instructions carefully.
3. Shade your answers in the Optical Answer Sheet (OAS) provided.
4. You are not allowed to use a calculator.
5. Answer all questions.

Section	Maximum Mark	Marks Obtained
Paper 1 (Booklet A)	20	

* This booklet consists of 9 pages (including this cover page).

This paper is not to be reproduced in part or whole without the permission of the Principal.

Questions 1 to 10 carry 1 mark each. Questions 11 to 15 carry 2 marks each.
For each question, four options are given. One of them is the correct answer.
Make your choice (1, 2, 3 or 4). Shade the oval (1, 2, 3 or 4) on the Optical Answer Sheet.

All diagrams in this paper are not drawn to scale unless stated otherwise.

(20 marks)

1. Which one of the following numbers is the largest?

- (1) 2.032
- (2) 2.302
- (3) 2.230
- (4) 2.023

2. Mark bought $2k$ boxes of erasers. Each box contained 10 erasers. What was the total number of erasers he bought?

- (1) $2k + 10$
- (2) $2k + 20$
- (3) $12k$
- (4) $20k$

3. The opening times of Sharkie Restaurant is shown below.
For how long is the restaurant open each day?

- (1) 7 h 15 min
- (2) 7 h 30 min
- (3) 7 h 45 min
- (4) 10 h 30 min

Opens Daily

Lunch :
11.30 a.m. to 2.45 p.m.

Closed for Break
2.45 p.m. to 5.45 p.m.

Dinner:
5.45 p.m. to 10.00 p.m.

4. In the diagram, A, B and C are 3 points on the ground. Point A is north of Point B and the $\angle ABC$ is 225° . In what direction is point C from point B?

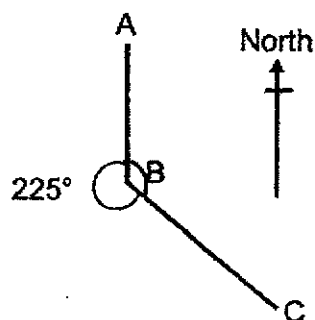

- (1) South-West
(2) North-West
(3) South-East
(4) North-East
5. The top of the tree reaches the 4th storey of a block of flat. Which of the following could be the height of the tree?

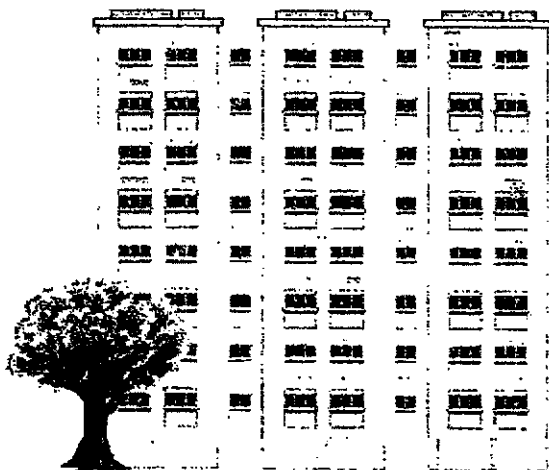

- (1) 1.02 km
(2) 1.2 m
(3) 12 m
(4) 102 cm

6. AB, CD and EF are all straight lines.

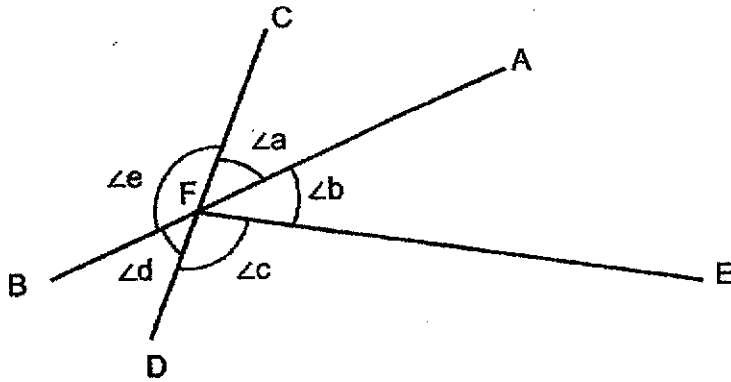

Which of the following statements is true?

- (1) $\angle e = \angle b$
- (2) $\angle b = \angle d$
- (3) $\angle a + \angle b = \angle d$
- (4) $\angle b + \angle c = \angle e$

7. The letters M, R, A, Z and E are written in the square grid shown below. Which of the options given list all the letters that have perpendicular lines?

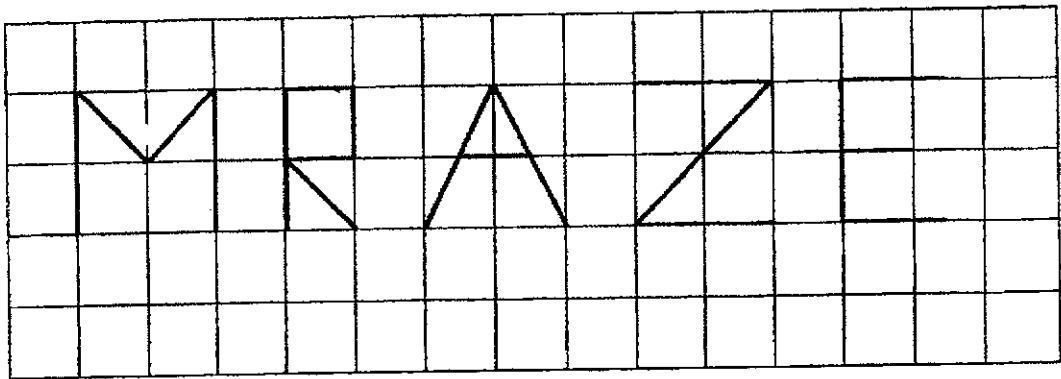

- (1) E and R
- (2) A, E and R
- (3) E, M and R
- (4) E, M, R and Z

8. A group of children was asked to choose their favourite animal. Each child can choose more than one animal. The table represents the children's choices. The children's choices were also represented by a bar graph.

Animal	Cat	Dog	Hamster	Rabbit
Percentage	10%	60%	40%	10%

Which of the following bar graphs best represents the information shown in the table above?

(1)

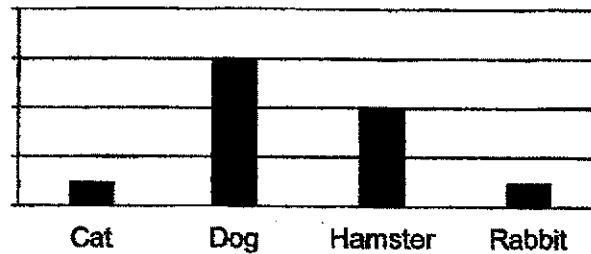

(2)

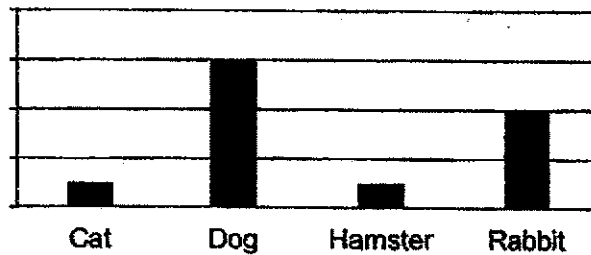

(3)

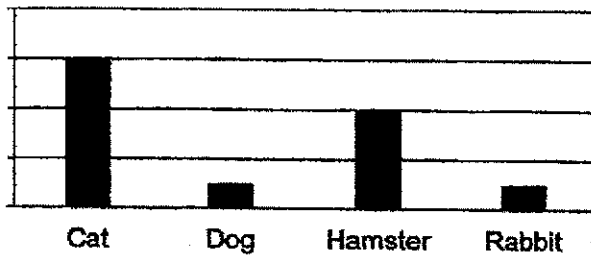

(4)

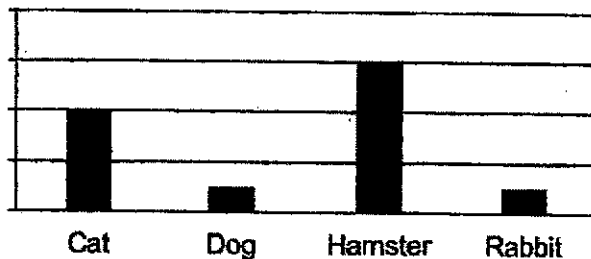

9. Alynna had an empty piggy bank. Each week, Alynna would put some money into her piggy bank. The graph below shows the amount of money she had in her piggy bank at the end of each week.

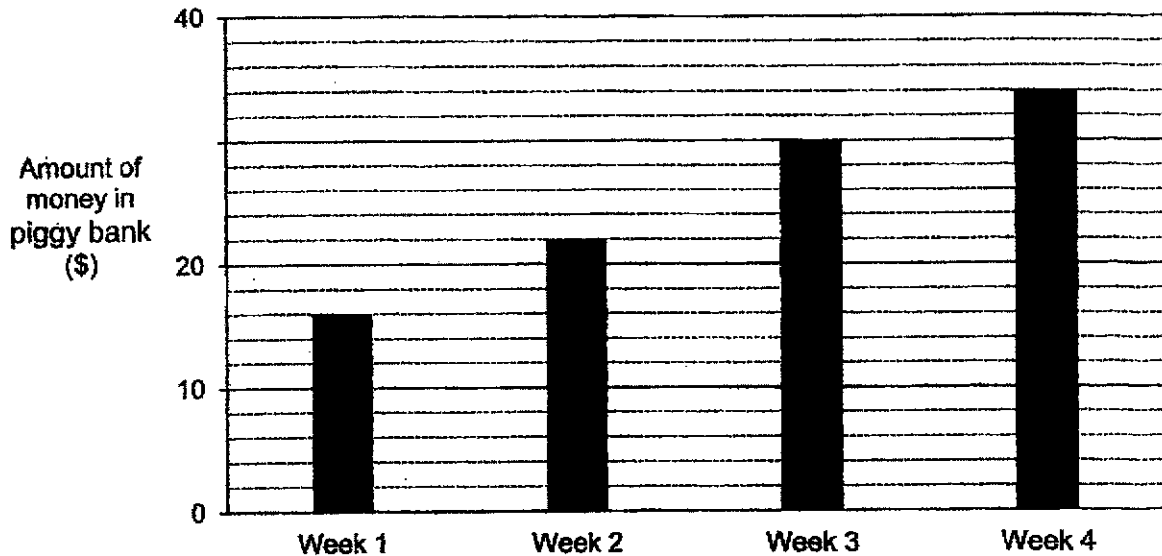

In which week did Alynna put in the most amount of money into her piggy bank?

- (1) Week 1
 (2) Week 2
 (3) Week 3
 (4) Week 4
10. Mary's father bought her a laptop at \$2500. She had to repay him an equal amount of money each day for the laptop. She took 1000 days to pay him back. How much did she repay her father each day?
- (1) \$0.25
 (2) \$2.50
 (3) \$25
 (4) \$250

11. Jenny sews 2 masks in half an hour. Siti sews 3 masks in an hour. How long will both of them take to complete sewing 105 masks together?

- (1) 15 h
- (2) 21 h
- (3) 26 h
- (4) 30 h

12. Aishah cut out 4 identical right-angled triangles. Each right-angled triangle has a perimeter of 36 cm. She formed the shape shown below. What is the perimeter of the figure formed by the 4 right-angled triangles?

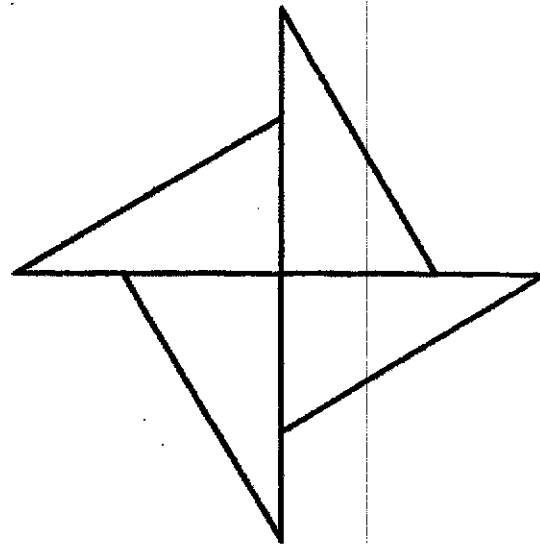
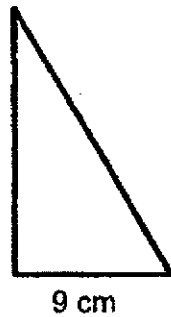

- (1) 72 cm
- (2) 108 cm
- (3) 144 cm
- (4) 180 cm

13. In a party, $\frac{1}{5}$ of the people are female and the rest are male. $\frac{1}{2}$ of the female are vegetarians. There are three times as many male vegetarians as female vegetarians.

What fraction of the people at the party are vegetarians?

- (1) $\frac{3}{10}$
 (2) $\frac{2}{5}$
 (3) $\frac{3}{5}$
 (4) $\frac{7}{10}$

14. In the figure, STUV is a trapezium and triangle RSU is an isosceles triangle. $\angle RSV = 24^\circ$, $\angle TSU = 64^\circ$, $\angle TUV = 84^\circ$ and $\angle SUR = 72^\circ$. Find $\angle STU$.

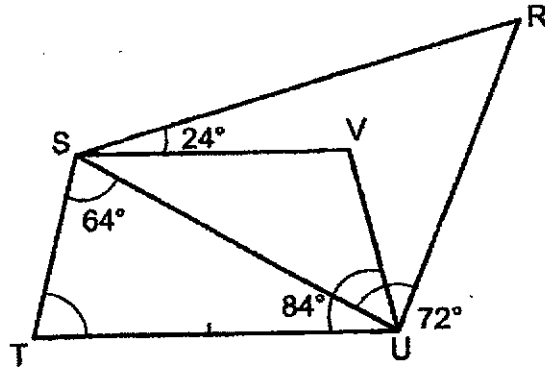

- (1) 62°
 (2) 84°
 (3) 86°
 (4) 96°

15. Sharon has 3 more 20-cent coins than 50-cent coins. The total value of all her coins is \$10.40. How many 20-cent coins does she have?
- (1) 11
 - (2) 12
 - (3) 14
 - (4) 17



**ROSYTH SCHOOL
2021 PRELIMINARY EXAMINATION
MATHEMATICS
PRIMARY 6
PAPER 1**

Name: _____

Register No. _____

Class: Pr 6 - _____

Group: _____

Date: 24 August 2021

Parent's Signature: _____

Total Time for Booklets A and B : 1 hour

BOOKLET B

Instructions to Pupils:

1. Do not open this booklet until you are told to do so.
2. Follow all instructions carefully.
3. You are **not** allowed to use a calculator.
4. Write your answers in the booklet.
5. Answer all questions.

Section	Maximum Mark	Marks Obtained
Paper 1 (Booklet B)	25	

* This booklet consists of 9 pages (including this cover page).

This paper is not to be reproduced in part or whole without the permission of the Principal.

Questions 16 to 20 carry 1 mark each. Write your answers in the spaces provided. For questions which require units, give your answers in the units stated.

Do not write
in this space

All diagrams in this paper are not drawn to scale unless stated otherwise.
(5 marks)

16. Find the value of $20 - 8 \div 4 \times (2 + 6) + 1$.

Ans: _____

17. A watch cost \$120 before discount. How much would Mr Lim pay for the watch after discount?

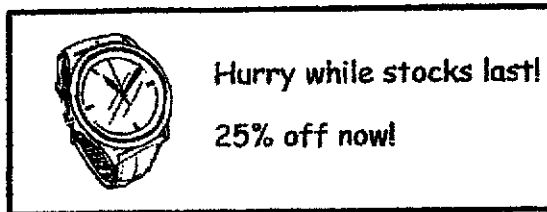

Ans: \$ _____

18. The graph below shows the mass of durians sold at a shop over four days. Do not write in this space

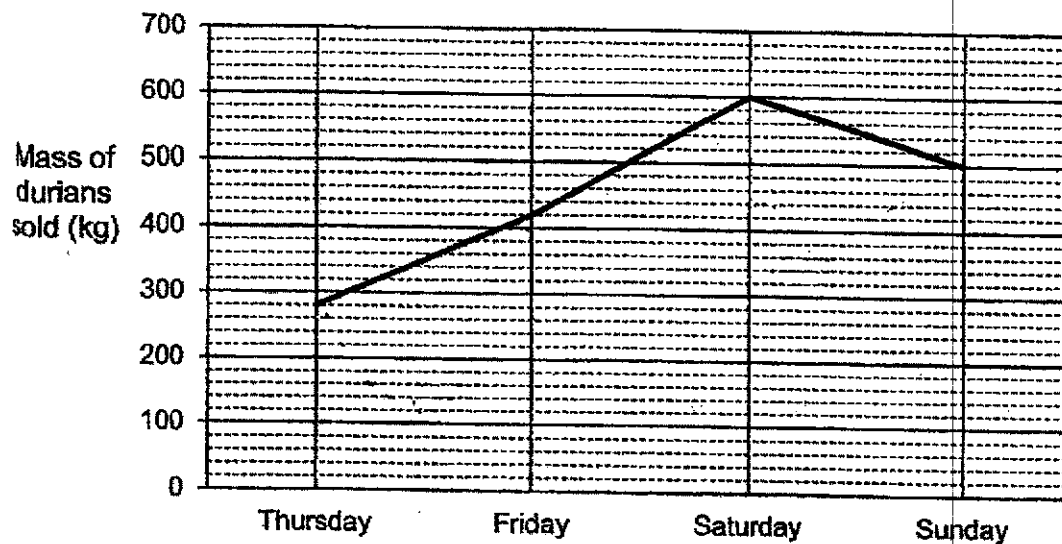

The cost of 1 kg of durians was \$20. How much money was collected over the four days?

Ans: \$ _____

19. 3 triangles are drawn in the grid shown below. Which triangle has the same area as Rectangle Z?

Do not write in this space

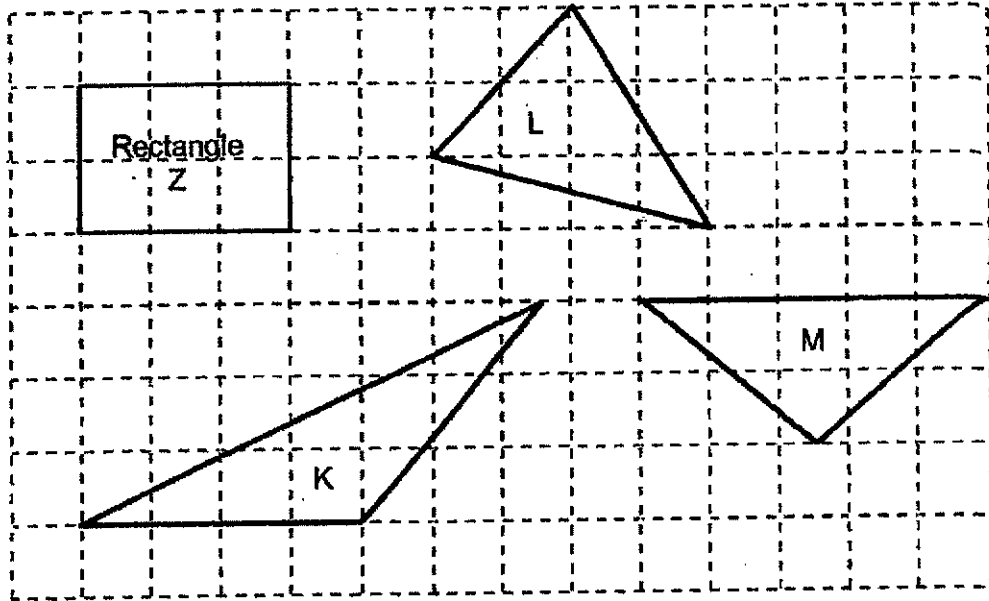

Ans: _____



20. The figure is made up of identical triangles. Shade 2 more triangles so that line XY is the line of symmetry for the figure.

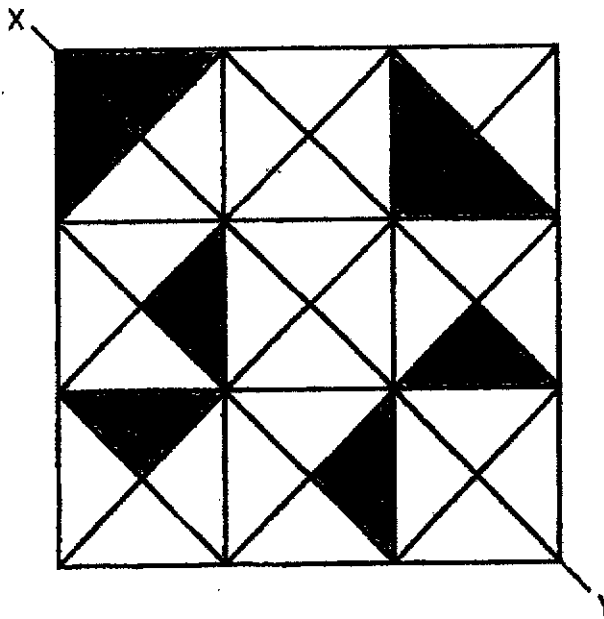

Questions 21 to 30 carry 2 marks each. Show your workings clearly in the space provided for each question and write your answers in the spaces provided. For questions which require units, give your answers in the units stated. Do not write in this space

All diagrams in this paper are not drawn to scale unless stated otherwise.

(20 marks)

21. The fraction $\frac{1}{7}$ expressed as a decimal is 0.1428571428571428571....
What is the 32nd digit after the decimal point?

Ans: _____

22. A combination lock has a 3-digit code which has the same digits and is represented by AAA.

AAA has 4 factors. What is the value of A?

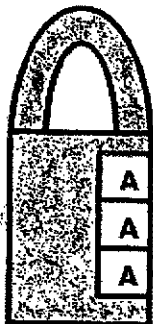

Combination Lock

Ans: _____

23. Sarah has 1.08 litres of orange juice. She wants to pour 90 ml of orange juice into each cup. How many cups can she fill?

Ans: _____

24. Matthew had \$83. He spent the entire amount of money on the 3 items shown below. Find the value of y .



$\$y$

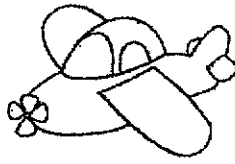

$\$(y - 1)$

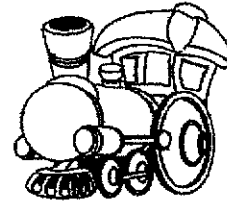

$\$(2y)$

Ans: _____

Do not write
in this space

25. There were 162 pages in a story book. Eve read $\frac{1}{2}$ of the story book on Monday. She read $\frac{1}{3}$ of the remainder on Tuesday. The rest of the pages were read equally on Wednesday and Thursday. How many pages did she read on Thursday?

Ans: _____

26. The average of three different 3-digit numbers is 123. One of the numbers is 107. Find the smallest possible difference between the two other numbers.

Ans: _____

27. The figure is made up of 2 squares, DEFG, JKFL and a rectangle, PQFR. $\angle QFE$ is 43° and $\angle RFK$ is 156° . Find $\angle LFE$.

Do not write in this space

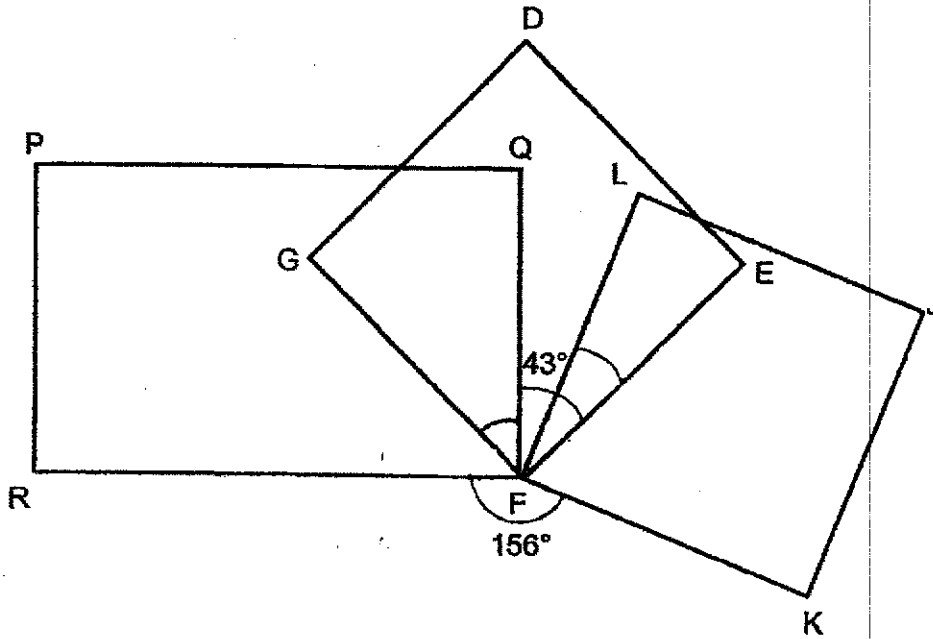

Ans: _____ °



28. The 2 bar graphs showed the number of bottles of different flavoured milk sold on Monday and Tuesday.

Do not write in this space

Bottles of Milk Sold on Monday

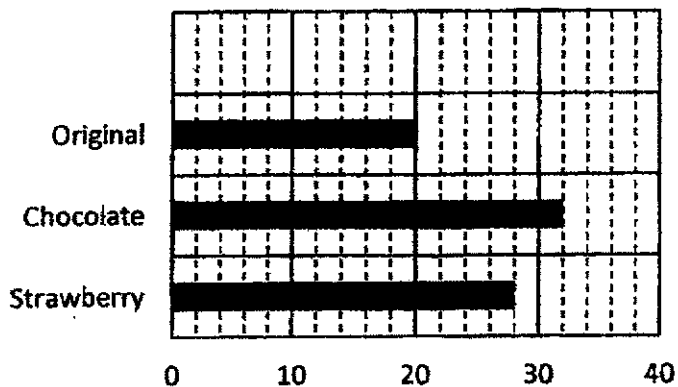

Bottles of Milk Sold on Tuesday

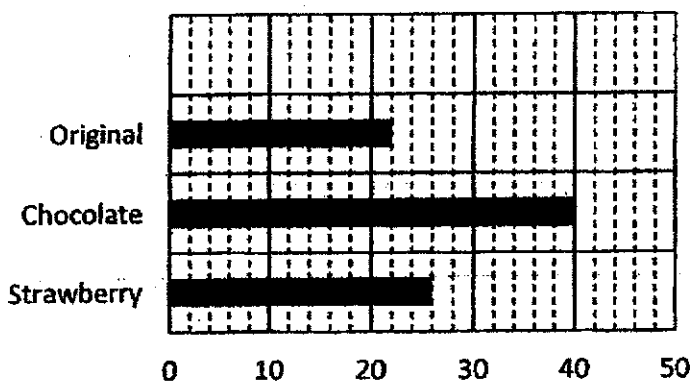

What was the percentage increase in the number of bottles of milk sold on Tuesday?

Ans: _____ %

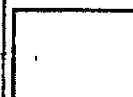

29. The figure is made up of a rhombus, DEFG, and a square, DEHC. $\angle DGF = 133^\circ$. Find $\angle DCG$.

Do not write in this space

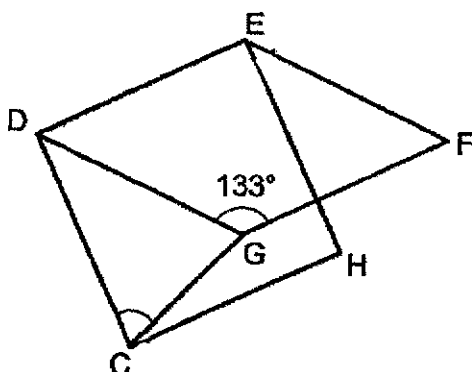

Ans: _____ °

30. The table below shows the amount of money donated by each student in a class. Part of the table is covered by an ink blot. $\frac{1}{2}$ of the class donated at least \$2.

Amount of Money	\$0	\$1	\$2	\$5	\$10
Number of students	6	12	7		

Each of the statements is either true, false or not possible to tell from the information given. For each statement, put a tick (✓) to indicate your answer.

Statements	True	False	Not Possible to tell
The amount of money donated by the most number of students is \$1.			
More than $\frac{1}{2}$ of the amount of money is donated by the remaining students.			

End of paper
Have you checked your work?



ROSYTH SCHOOL
2021 PRELIMINARY EXAMINATION
MATHEMATICS
PRIMARY 6
PAPER 2

Name: _____ Register No. _____

Class: Pr 6 - _____ Group No: _____

Date: 24 August 2021 Parent's Signature: _____

Time: 1h 30min

Instructions to Pupils:

1. Do not open this booklet until you are told to do so.
2. Follow all instructions carefully.
3. **Show your workings clearly** as marks are awarded for correct working.
4. Write your answers in this booklet.
5. You are allowed to use a calculator.
6. Answer all questions.

Questions	Maximum Mark	Marks Obtained
Q 1 to 5	10	
Q 6 to 17	45	

Section	Maximum Mark	Marks Obtained
Paper 1	45	
Paper 2	55	
Total	100	

* This booklet consists of 16 pages (including this cover page)
 This paper is not to be reproduced in part or whole without the permission of the Principal.

Questions 1 to 5 carry 2 marks each. Show your working clearly in the space provided for each question and write your answers in the spaces provided. For questions which require units, give your answers in the units stated.

(10 marks)

Do not write
in this space

All diagrams in this paper are not drawn to scale unless stated otherwise.

1. At 10 a.m., Ali and John set their alarm clocks to ring. Ali set his alarm clock to ring every 15 minutes. John set his alarm clock to ring every 20 minutes. At what time will it take for both their alarm clocks to ring together for the first time?

Ans: _____ a.m.

2. The table below shows the prices of a bottle of hand sanitiser and a box of face masks at a shop.

Item	Price
A bottle of hand sanitiser	$\$w$
A box of face masks	$\$(w + 8)$

Mdm Toh paid \$265 for 15 bottles of hand sanitisers and some boxes of face masks. If $w = 3$, how many boxes of face masks did Mdm Toh buy?

Ans: _____

3. Caitlin wanted to cut out isosceles triangles with a base of 2 cm and a height of 2 cm as shown below from a rectangular piece of paper. The paper measures 16 cm by 25 cm. What is the most number of such triangles that she can cut out?

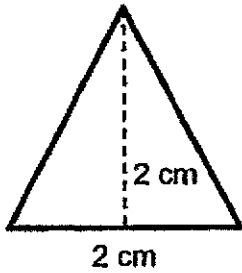

Do not write in this space

Ans:

4. Two triangles, KLM and JKL, are shown in the figure below. Find $\angle LJK$.

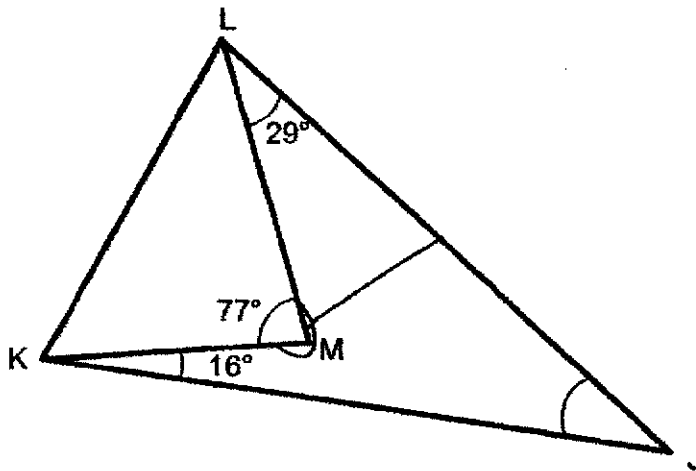

Ans: _____ °

5. Sam only had the following notes and coins in his saving box. The notes are \$2, \$5 and \$10. The coins are 10¢, 20¢ and 50¢. On Saturday, he took out the least amount with a note and a coin. On Sunday, he took out the most amount with a note and a coin. What was the total amount of money taken out from the saving box on Saturday and Sunday?

Do not write
in this space

Ans: _____

For Questions 6 to 17, show your working clearly in the space provided for each question and write your answers in the spaces provided. The number of marks available is shown in brackets [] at the end of each question or part-question. For questions which require units, give your answers in the units stated.

Do not write
in this space

All diagrams in this paper are not drawn to scale unless stated otherwise.
(45 marks)

6. $\frac{3}{4}$ of the cost of a laptop is equal to $\frac{1}{2}$ of the cost of a television. The total cost of the 2 items is \$2400 after a 20% discount. How much is the cost of the laptop before discount?

Ans: _____ [3]

7. Machine A is able to print 50 stars in a minute. For every 1000 stars that Machine A prints, Machine B is able to print 500 more stars than Machine A. How many more stars will Machine B print in 2 hours than Machine A?

Ans: _____ [3]

8. There were three types of flowers in a garden. There were 352 stalks of orchids. The ratio of the number of stalks of tulips to the number of stalks of lilies is 5 : 3. The total number of stalks of tulips and lilies was 56% of all the flowers. How many more stalks of orchids were there than tulips?

Do not write
in this space

Ans: _____ [3]

9. The figure shows 2 stacks of identical cups. There are 5 cups in the shorter stack and 12 cups in the taller stack.

The height of the shorter stack is 20 cm and the height of the taller stack is 41 cm.

Shi Yao wants to pack the cups as shown into a box 0.6 m long.

What is the most number of cups she can pack into the box?

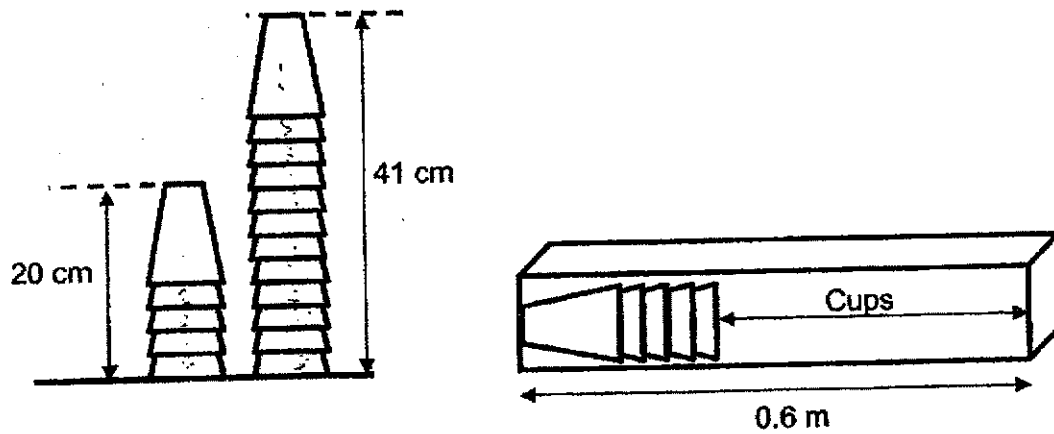

Do not write
in this space

Ans: _____ [3]



10. A trapezium, DEFG is drawn in the grid shown below.

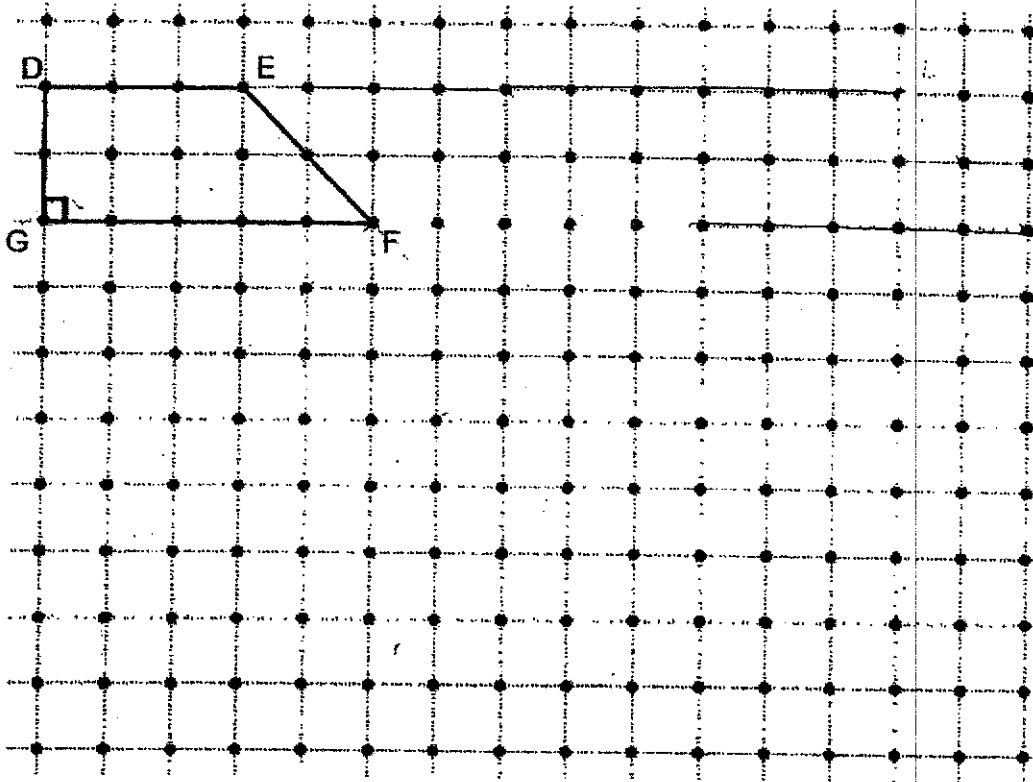

Do not write
in this space

By joining the dots in the grid with straight lines,

- (a) draw a parallelogram that has twice the perimeter of the trapezium DEFG. Using the line EF as one side, label it EFKL. [1m]
- (b) draw a square from point F that has the same area as the trapezium DEFG. Label it FMNP. [2m]

Both parallelogram EFKL and the square should not overlap the trapezium DEFG and each other.



11. An equal number of children attended Camp A and Camp B. The ratio of the number of girls to the number of boys in Camp A was 5 : 9. The ratio of the number of girls to the number of boys in Camp B was 4 : 1. Altogether, there were 132 more girls than boys. How many children were there in both camps?

Do not write
in this space

Ans: _____ [4]



12. The table below shows the different types of juices sold at a stall.

Type of Juices	Volume of juice per bottle
Apple	250 ml
Watermelon	500 ml
Orange	600 ml

The bar graph shows the number of bottles of each type of juice sold at the stall on a Monday. The bar that shows the number of bottles of orange juice sold has not been drawn.

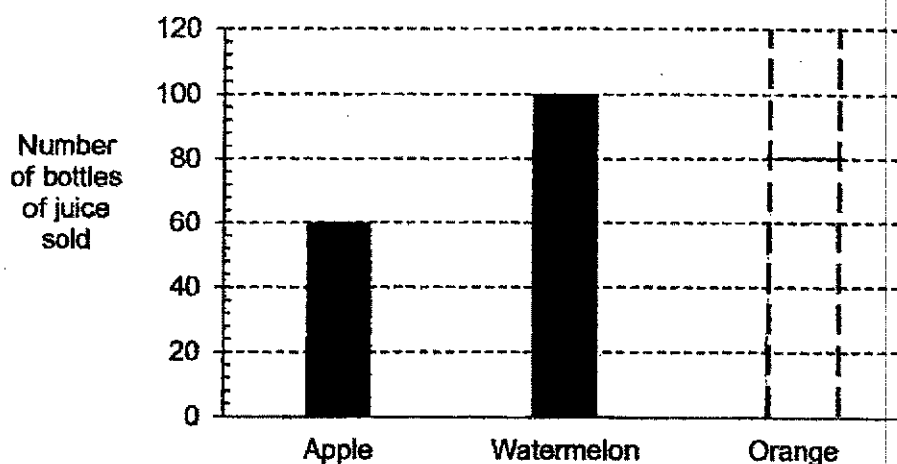

- (a) The total volume of orange juice sold was 48 litres. Draw the bar representing the number of bottles of orange juice sold in the bar graph above. You are not required to shade the bar. [2]
- (b) On the next day, the number of bottles of apple juice sold decreased by 25%. The number of the bottles of watermelon juice and orange juice sold remained the same. What fraction of the bottles sold were apple juice?

Ans: (b) _____ [2]

Do not write
in this space

13. Claire had a roll of wire that was used to make stars. She used 3.75 m of the wire to make 12 small stars and 15 big stars. There was some remaining wire left. She could not make a big star with the remaining wire as she would be short of 4 cm of wire. So she made a small star with the remaining wire instead and had 3 cm of wire left.



- (a) What was the difference in the length of wire used to make a big star and a small star?
- (b) What was the length of the roll of wire Claire had at first?

Do not write
in this space

Ans: (a) _____ [1]

(b) _____ [3]



14. The figure shown below is made up of identical semi-circles of different sizes, 2 small, 4 medium and 4 large. The length of the figure is 30 m. Each of the small semi-circle has a diameter of 5 m.

Do not write
in this space

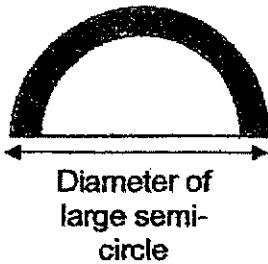
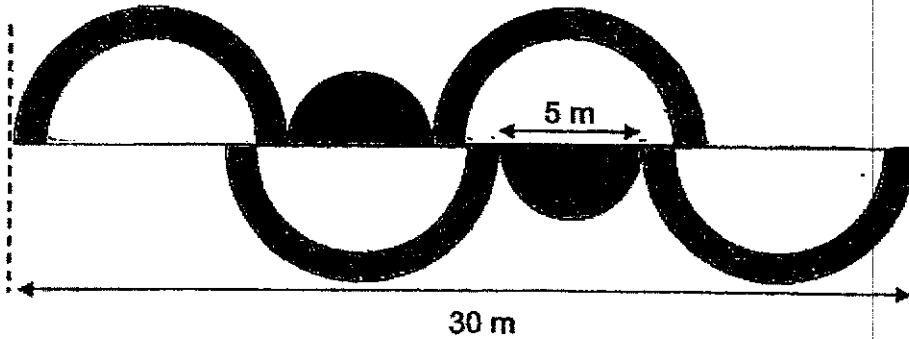

- (a) Find the diameter of 1 large semi-circle.
- (b) Find the total area of all the shaded portions. (Take $\pi = 3.14$)
Express your answer to 2 decimal places.

You may continue your working on the next page

14. Continue your working here for question 14.

Do not write
in this space

Ans: (a) _____ [1]

(b) _____ [3]

15. In the figure shown below, QRST is a parallelogram. WR, WS, SU and VS are all straight lines. $\angle SWV = 34^\circ$, $\angle WSV = 17^\circ$, $\angle QTS = 43^\circ$ and $\angle RSU$ is 122° .

- (a) Find $\angle TSU$.
 (b) Find $\angle RSX$.
 (c) Find $\angle VXY$.

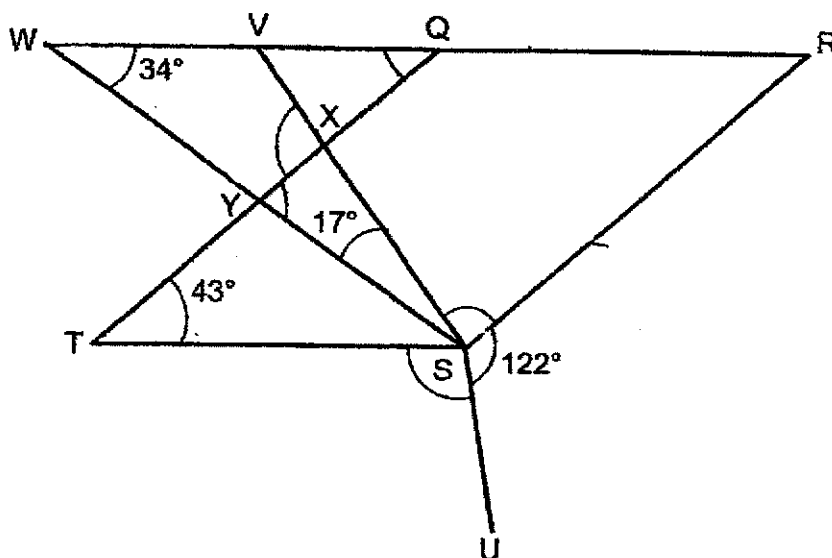

Do not write
in this space

- Ans: (a) _____ [1]
 (b) _____ [2]
 (c) _____ [1]

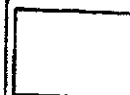

16. Serene had some oranges in her shop. She sold $\frac{1}{6}$ of them in the afternoon and 280 of the oranges in the evening. She was left with $\frac{3}{5}$ of the oranges. She packed these remaining oranges into boxes.

Some of the boxes contained 8 oranges while the rest of the boxes contained 12 oranges.

- (a) How many oranges were packed into the boxes?
(b) She packed 20 more boxes with 8 oranges than boxes with 12 oranges. How many boxes were used to pack 8 oranges?

Do not write
in this space

Ans: (a) _____ [2]

(b) _____ [3]

17. Below shows the prices of some items at a bookshop.

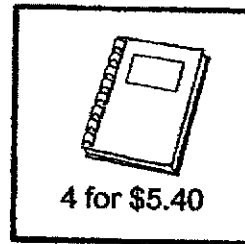

- (a) Kenny bought 2 calculators and 16 notebooks for \$60.30. There was a discount given on the calculators only. What was the percentage discount of the calculators?
- (b) Mr Koh bought an equal number of calculators and notebooks without any discount. He spent \$1467 more on the calculators than the notebooks. How many notebooks did he buy?

Do not write
in this space

Ans: (a) _____ [2]
(b) _____ [3]



End of Paper

ANSWER KEY

YEAR : 2021
LEVEL : PRIMARY 6
SCHOOL : ROSYTH
SUBJECT : MATHEMATICS
TERM : PRELIMINARY

BOOKLET A (PAPER 1)

Q1	2	Q2	4	Q3	2	Q4	3	Q5	3
Q6	4	Q7	3	Q8	1	Q9	1	Q10	2
Q11	1	Q12	1	Q13	2	Q14	3	Q15	4

BOOKLET B (PAPER 1)

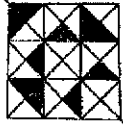
Q16	5	Q17	$120 \times 75\% = \$90$
Q18	SOLD---1800kg Money collected – $1800 \times \$20$ = \$36000	Q19	K
Q20		Q21	$32 \div 6 = 5R2$ ANS : 4
Q22	1	Q23	$108 = 108 \times 1000 = 1080$ $1080 \div 90 = 12$
Q24	$Y - 84 \div 4 = \$21$	Q25	$162 \times \frac{1}{2} \times \frac{1}{3} = 27$
Q26	$262 \div 2 = 131$ $131 + 1 = 132$ $131 - 1 = 130$ $132 + 30 = 2$ ANS : 2	Q27	$90 - 71 = 19^\circ$
Q28	$\frac{88-80}{80} \times 100\% = 10\%$	Q29	$\angle DCG = \frac{180^\circ - 43^\circ}{2} = 68.5^\circ$
Q30	True True		

PAPER 2

Q1	11 a.m	Q2	$265 - 15 \times 3 = 220$ Box --- $220 \div 11 = 20$
Q3	$15 \div 2 = 12R1$	Q4	$360 - 283 - 29 - 16 = 32^\circ$

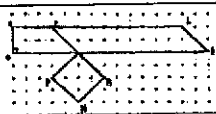
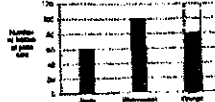
	$12 \times 2 = 24$ $24 \times 8 = 192$		
Q5	\$12.60	Q6	$44 - 4 \times 300 = \$1200$
Q7	Diff : $9000 - 6000 = 3000$ stars	Q8	$56 \div 8 \times 5 = 35\%$ $35\% - 35 \times 8 = 280$ $352 - 280 = 72$
Q9	$\frac{60-8}{3} = 17r1$ $17 + 1 = 18$	Q10	A,B) 
Q11	$25u + 56u - 45u - 14u = 22u$ $22u \rightarrow 132$ $140u \rightarrow 132 \div 22 \times 140 = 840$	Q12	a)  b) Apple $\rightarrow 60 \times 75\% = 45$ $\frac{45}{45+100+80} = \frac{1}{5}$
Q13	a) $4 + 3 = 7$ b) $3.75m = 375cm$ $27x \rightarrow 375 - 105 = 270$ $x \rightarrow 270 \div 27 = 10$ Length at first $\rightarrow (10 \times 12 + 15 \times 10 + 7 \times 15) + 10 + 3 = 388cm$	Q14	a) $\frac{30-4 \times 5}{5} = 2$ $5 + 2 + 2 = 9m$ b) Shaded = $(2 \times 3.14 \times 4.5 \times 4.5) - (2 \times 3.14 \times 3.5 \times 3.5) + (3.14 \times 2.5 \times 2.5)$ $= 127.17 - 76.93 + 19.625$ $\approx 69.87cm^2$
Q15	a) $\angle WST \rightarrow 34^\circ$ $\angle RSX \rightarrow 180^\circ - 34^\circ - 170^\circ - 43^\circ = 86^\circ$ $\angle TSU \rightarrow 360^\circ - 34^\circ - 17^\circ - 86^\circ - 122^\circ = 101^\circ$ b) $\angle QXV \rightarrow 137^\circ - 51^\circ = 86^\circ$ c) $\angle VXY \rightarrow 180^\circ - 86^\circ = 94^\circ$	Q16	a) $\frac{3}{5} \rightarrow 1200 \times \frac{3}{5} = 720$ b) $12 \times 20 = 240$ $720 + 240 = 960$ $960 \div (8+12) = 48$
Q17	a) % discount \rightarrow $\frac{\$25.80 - \$19.35}{\$25.80} \times 100\% = 25\%$ b) Small diss \rightarrow $\$25.80 - \frac{\$5.40}{4} = \$24.45$ $\$1467 \div \$24.45 = 60$		