

SA2



HENRY PARK PRIMARY SCHOOL  
2021 PRELIMINARY EXAMINATION  
MATHEMATICS  
PRIMARY 6

PAPER 1  
(BOOKLET A)

Name: \_\_\_\_\_

Parent's Signature

Class: Primary \_\_\_\_\_

Marks:

Paper 1	Booklet A	20
	Booklet B	25
Paper 2		55
Total		100

Total Time for Booklets A and B: 1 hour

Do not turn over this page until you are told to do so.

Follow all instructions carefully.

Answer all questions.

Shade your answers in the Optical Answer Sheet (OAS) provided.

You are not allowed to use a calculator.



Questions 1 to 10 carry 1 mark each. Questions 11 to 15 carry 2 marks each. For each question, four options are given. One of them is the correct answer. Make your choice (1, 2, 3 or 4) and shade your answer in the Optical Answer Sheet.

(20 marks)

1 Round 21.356 to the nearest tenth.

- (1) 20.0
- (2) 21.0
- (3) 21.3
- (4) 21.4

2 Find the value of  $6 + 12 \div 3 \times 2$

- (1) 12
- (2) 14
- (3) 3
- (4) 20

3 Which one of the following is closest to the reading shown on the weighing scale below?

- (1) 36.6 kg
- (2) 38.1 kg
- (3) 38.6 kg
- (4) 39.4 kg

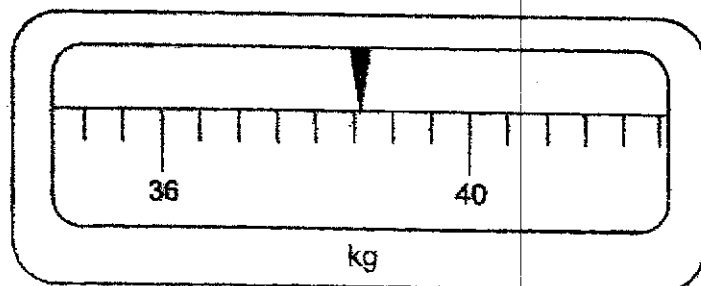

4 Express 25 seconds as a fraction of 2 minutes.

- (1)  $\frac{1}{8}$   
 (2)  $\frac{2}{25}$   
 (3)  $\frac{5}{12}$   
 (4)  $\frac{5}{24}$

5 Which two lines are perpendicular to each other?

- (1) BE and CD  
 (2) FA and FD  
 (3) FD and BE  
 (4) FD and FE

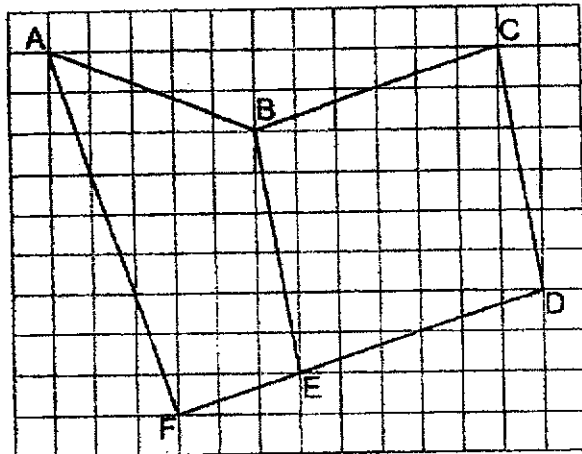

6 Ravi has  $\frac{3}{4}$  as many stamps as Peter. Find the ratio of the number of stamps Peter has to the total number of stamps the two boys have.

- (1) 3 : 4  
 (2) 3 : 7  
 (3) 4 : 3  
 (4) 4 : 7

- 7 Ken cycled along a track from 5.30 p.m. to 6.50 p.m. Lee cycled along the same track from 5.40 p.m. to 7.20 p.m. How much longer did Lee cycle than Ken?

- (1) 10 min  
 (2) 20 min  
 (3) 30 min  
 (4) 40 min

- 8 The figure is made up of a quarter circle of radius 8 cm and a semicircle. Find the area of the semicircle.

- (1)  $32\pi \text{ cm}^2$   
 (2)  $16\pi \text{ cm}^2$   
 (3)  $8\pi \text{ cm}^2$   
 (4)  $4\pi \text{ cm}^2$

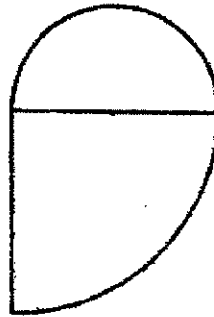

- 9 Arrange the following distances from the longest to the shortest.

9.45 km

9 km 95 m

$9\frac{3}{5}$  km

- |     | <u>Longest</u>     |                    | <u>Shortest</u>   |
|-----|--------------------|--------------------|-------------------|
| (1) | $9\frac{3}{5}$ km, | 9.45 km,           | 9 km 95 m         |
| (2) | $9\frac{3}{5}$ km, | 9 km 95 m,         | 9.45 km           |
| (3) | 9.45 km,           | $9\frac{3}{5}$ km, | 9 km 95 m         |
| (4) | 9 km 95 m,         | 9.45 km,           | $9\frac{3}{5}$ km |

Use the information below to answer Questions 10 and 11.

The bar graph below shows the number of computers sold in each month from August to November. The bar for the number of computers sold in November has not been drawn.

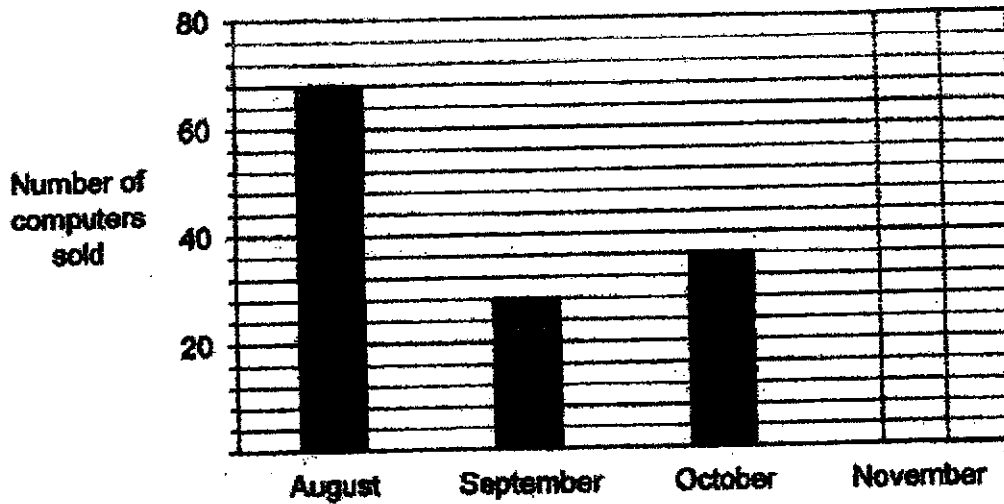

- 10 How many computers did the shop sell altogether in August and September?
- (1) 80  
 (2) 84  
 (3) 90  
 (4) 96
- 11 The number of computers sold in November was a 25% increase from the number of computers sold in October. How many computers were sold in November?
- (1) 9  
 (2) 27  
 (3) 45  
 (4) 63

- 12 At first, there were 60 red apples and 40 green apples in a basket. Mrs Lim then sold 10% of the red apples and 25% of the green apples. What percentage of the apples in the basket did she have left?

- (1) 16%  
 (2) 35%  
 (3) 65%  
 (4) 84%

- 13 In the figure below, ABCD is a trapezium where CD is parallel to AB. Given that  $AE = DE$ , find  $\angle EAB$ .

- (1)  $31^\circ$   
 (2)  $49^\circ$   
 (3)  $59^\circ$   
 (4)  $72^\circ$

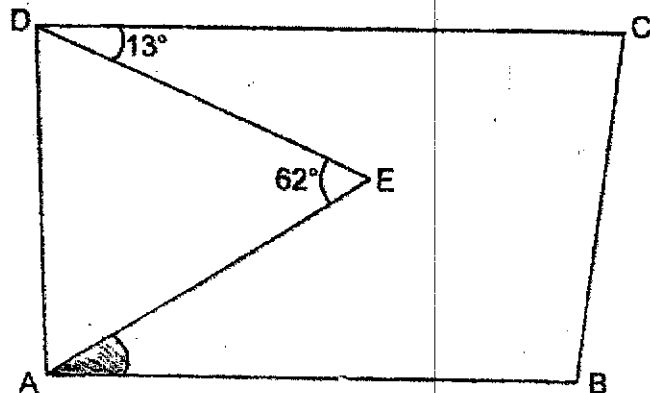

- 14 At first, Alex and Melissa were facing the same direction. Then, Melissa turned  $225^\circ$  anti-clockwise to face East and Alex turned  $90^\circ$  clockwise. Which direction did Alex face in the end?

- (1) North-East  
 (2) North-West  
 (3) South-East  
 (4) South-West

- 15 Maliki cut a square piece of paper measuring 12 cm in length into 2 pieces of squares and 2 pieces of rectangles as shown in Figure 1. He arranged the pieces to form a big rectangle as shown in Figure 2. What is the perimeter of the big rectangle in Figure 2?

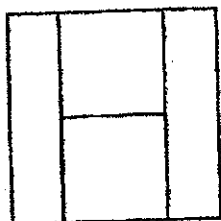

Figure 1

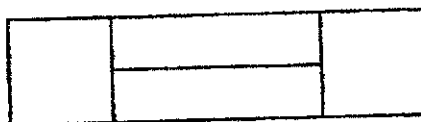

Figure 2

- (1) 48 cm
- (2) 60 cm
- (3) 108 cm
- (4) 144 cm





HENRY PARK PRIMARY SCHOOL  
2021 PRELIMINARY EXAMINATION  
MATHEMATICS  
PRIMARY 6

PAPER 1  
(BOOKLET B)

Name \_\_\_\_\_

Class: \_\_\_\_\_

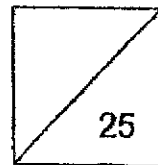

**Total Time for Booklets A and B: 1 hour**

**Do not turn over this page until you are told to do so.**

**Follow all instructions carefully.**

**Answer all questions.**

**Write your answers in this booklet.**

**You are not allowed to use a calculator.**

Questions 16 to 20 carry 1 mark each. Write your answers in the spaces provided.  
For questions which require units, give your answers in the units stated.

(5 marks)

Do not write  
in this space

- 16 Jane has five 50-cent coins, three 20-cent coins and seven 5-cent coins.  
What is the total value of all the coins that Jane has?

Ans: \$ \_\_\_\_\_

- 17 Find the value of  $24 + \frac{2}{3}$

Ans: \_\_\_\_\_

- 18 Express 0.019 as a percentage.

Ans: \_\_\_\_\_ %

19 Shade 3 more squares to form a symmetric figure with AB as the line of symmetry.

Do not write in this space

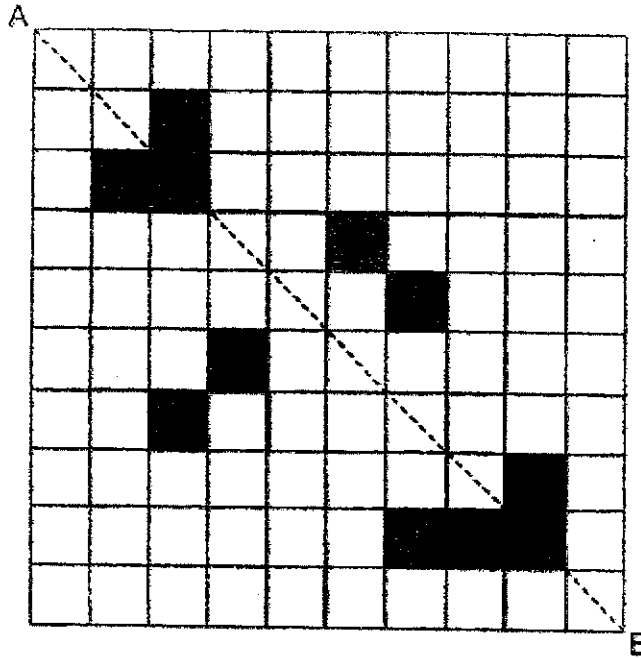

20 A rectangular tank contains water to a height of 20 cm as shown below. How much water (in ml) is needed to fill it to the brim?

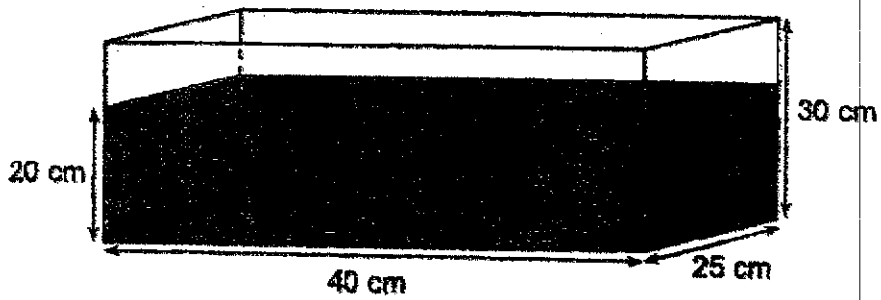

Ans: \_\_\_\_\_ ml

Questions 21 to 30 carry 2 marks each. Show your working clearly and write your answers in the spaces provided. For questions which require units, give your answers in the units stated.

(20 marks)

Do not write  
in this space

- 21 In the figure below, AOB and DOC are straight lines, FO is perpendicular to AB and  $\angle FOC = 43^\circ$ . Find  $\angle DOB$ .

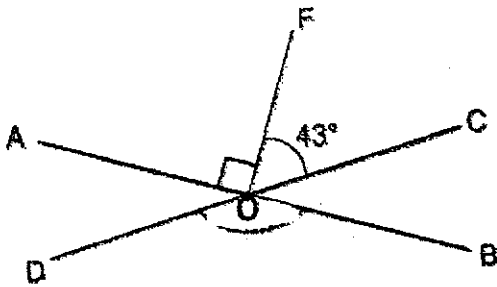

Ans: \_\_\_\_\_°

- 22 A photocopier can print 60 copies in 20 seconds. At this rate, how long will it take the photocopier to print 225 copies?

Ans: \_\_\_\_\_ s

- 23 The figure is made up of a rectangle and a quarter circle. Find the perimeter of the figure.  
 (Take  $\pi = 3.14$ )

Do not write in this space

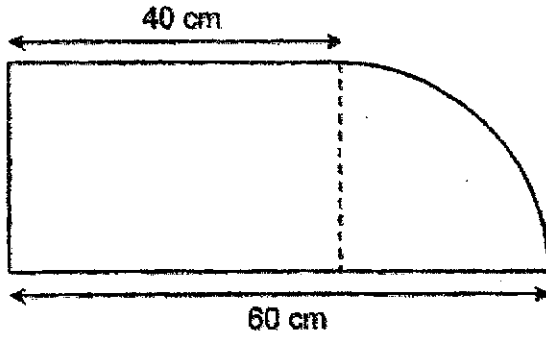

Ans: \_\_\_\_\_ cm

- 24 Max is 4 years older than Sue. In 8 years' time, Max will be 22 years old. What is the ratio of Sue's age to Max's age now? Express your answer in the simplest form.

Ans: \_\_\_\_\_



25 Joshua had a piece of wire measuring  $14k$  cm in length. He used it to form an equilateral triangle and had 4 cm of wire left.

Do not write in this space

- (a) Find the length of each side of the equilateral triangle in terms of  $k$  in the simplest form.
- (b) Find the perimeter of the equilateral triangle given that  $k = 8$

Ans: (a) \_\_\_\_\_ cm  
 (b) \_\_\_\_\_ cm

26 In the figure below, ABCD is a rectangle measuring 30 cm by 20 cm. E is a point on DC and DF = FC. Find the total area of the shaded parts.

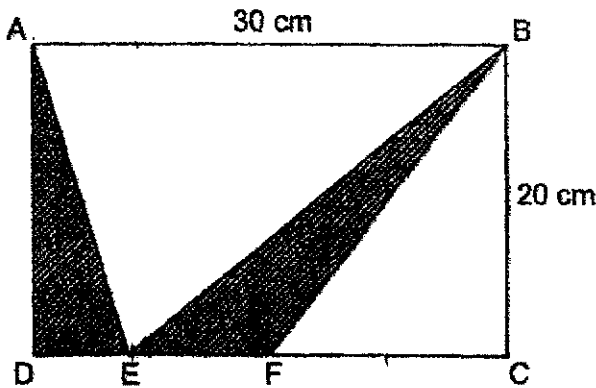

Ans: \_\_\_\_\_  $\text{cm}^2$

27

A triangle ABC is drawn on a square grid inside a box.

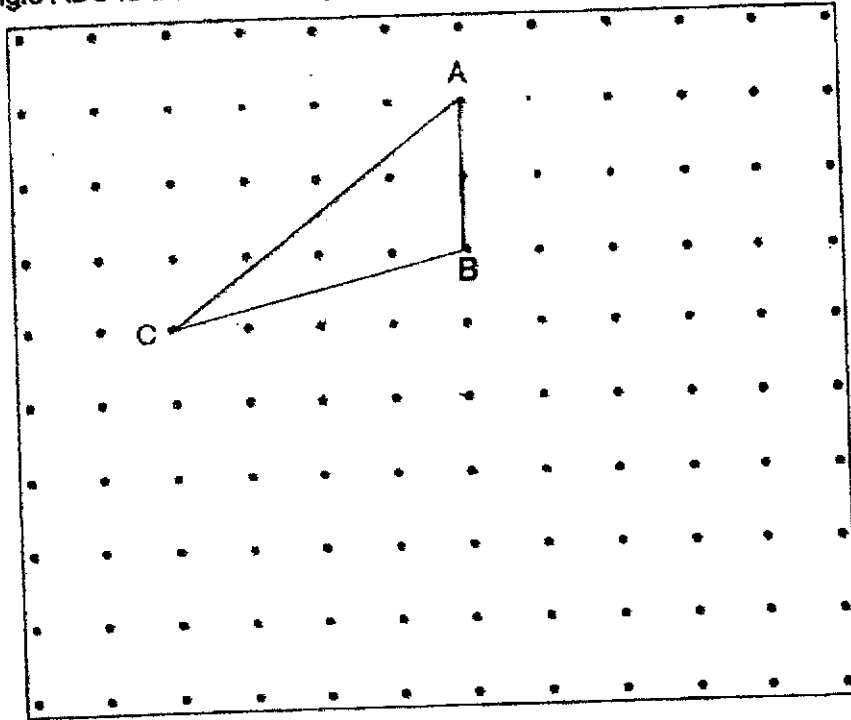

By joining dots on the grid with straight lines,

- (a) draw another triangle ABX such that the area of triangle ABX is half the area of triangle ABC.
- (b) draw a rhombus BCYZ such that  $\angle BCY$  is less than  $90^\circ$ . Rhombus BCYZ must not overlap with triangle ABC.

Do not write  
in this space

28

Ali made  $\frac{4}{5}$  litres of bandung drink using  $\frac{1}{4}$  litres of rose syrup and some milk. What fraction of the bandung drink was made up of rose syrup?

Ans: \_\_\_\_\_



29 Chocolates are sold at the prices shown below.

Do not write  
in this space

Type of chocolate	Price per packet of chocolates
Dark	\$2.50
White	\$2.00
Milk	\$1.20

The bar graph shows the number of packets of each type of chocolate that Noah bought.

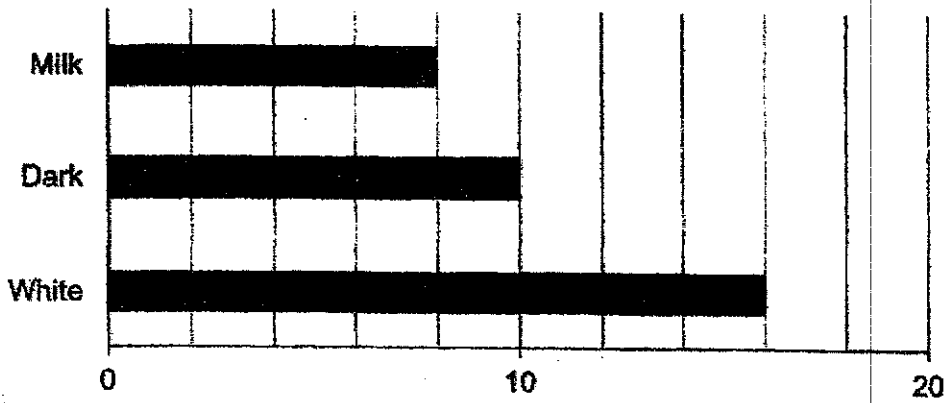

Find the total amount of money that Noah spent on the chocolates.

Ans: \$, \_\_\_\_\_

- 30 At first, chairs in a hall were arranged in rows of 12. Then, 57 more chairs were brought in and all the chairs were rearranged into rows of 21. In the end, there were 5 fewer rows. How many rows of chairs were there in the hall in the end?

Do not write  
in this space

Ans: \_\_\_\_\_



**HENRY PARK PRIMARY SCHOOL  
2021 PRELIMINARY EXAMINATION  
MATHEMATICS  
PRIMARY 6**

**PAPER 2**

Parent's Signature

Name

Class:

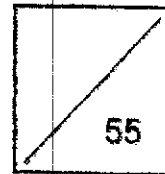

**Time for Paper 2: 1 hour 30 minutes**

**Do not turn over this page until you are told to do so.**

**Follow all instructions carefully.**

**Answer all questions.**

**Show your working clearly as marks are awarded for correct working.**

**Write your answers in this booklet.**

**You are allowed to use a calculator.**

Questions 1 to 5 carry 2 marks each. Show your working clearly and write your answers in the spaces provided. For questions which require units, give your answers in the units stated.

(10 marks)

Do not write  
in this space

- 1 A bag of 6 pears cost  $\$3w$ . Damon bought 54 pears and had  $\$42$  left. Given that he had  $\$150$  at first, find the value of  $w$ .

Ans: \_\_\_\_\_

- 2 The figure shows a parallelogram PQRS and a right-angled triangle PUT. Given that PUQ and PTS are straight lines and  $\angle STU = 137^\circ$ , find  $\angle PQR$ .

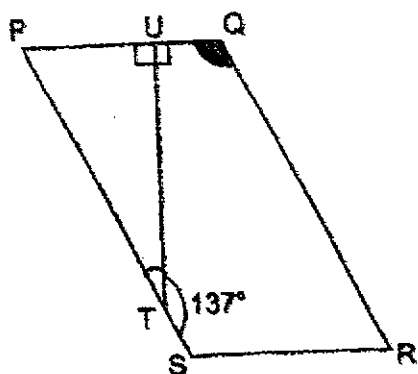

Ans: \_\_\_\_\_

- 3 The table below shows the charges for using the facilities in a gym.

Duration	Charges
1 <sup>st</sup> hour	\$8.00
Every additional $\frac{1}{2}$ hour or less	\$3.50

Leroy used the facilities in the gym from 9.30 a.m. to 12.30 p.m. How much did he pay?

Ans: \$ \_\_\_\_\_

Do not write  
in this space

- 4 The scores for Jaden's first three games in Round 1 are shown below.

Round 1	
Game	Marks
1 <sup>st</sup>	78
2 <sup>nd</sup>	106
3 <sup>rd</sup>	85
4 <sup>th</sup>	?

Jaden will move on to Round 2 if his average score of the four games in Round 1 is 95 or more. What is the lowest score Jaden must get in the 4<sup>th</sup> game to move on to Round 2?

Ans: \_\_\_\_\_

- 5 The figure is made up of a right-angled triangle and a semicircle. Given that  $AC = 70$  cm,  $AB = 56$  cm and  $BC = 42$  cm, find the total area of the shaded parts of the figure.

(Take  $\pi = \frac{22}{7}$ )

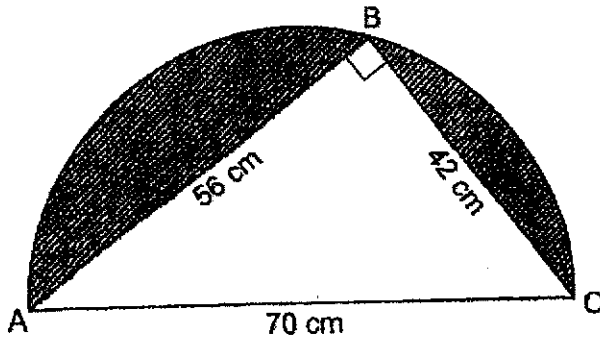

Do not write  
in this space

Ans: \_\_\_\_\_ cm<sup>2</sup>

For questions 6 to 17, show your working clearly and write your answers in the spaces provided. The number of marks available is shown in the brackets [ ] at the end of each question or part-question.

(45 marks)

Do not write in this space

- 6 The bar graph shows the number of electronic devices owned by each student in a school. The bar that shows the number of students who own 2 electronic devices each has not been drawn.

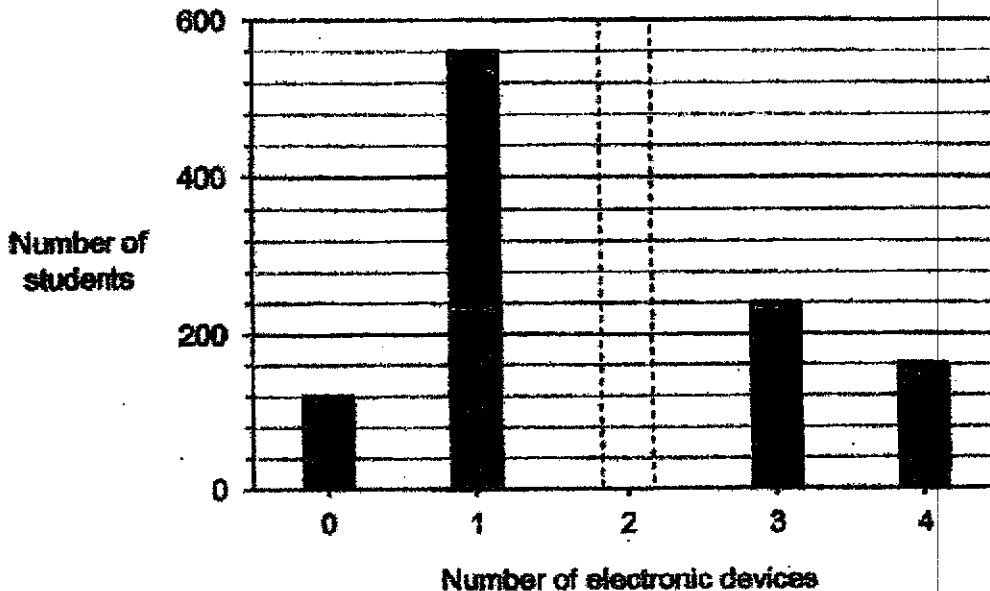

- (a) How many students do not own any electronic devices?
- (b) Given that  $\frac{1}{4}$  of the students have 2 electronic devices each, find the total number of students in the school.

Ans: (a) \_\_\_\_\_ [1]

(b) \_\_\_\_\_ [2]

7

Cheryl spent \$2016 in July. This amount was a 10% decrease from what she spent in June. The amount she spent in June was a 20% decrease from what she spent in May. How much did Cheryl spend in May?

Do not write  
in this space

Ans: \_\_\_\_\_ [3]



- 8 A roll of tape has three types of shapes,  $\heartsuit$ ,  $\clubsuit$  and  $\spadesuit$ , printed in a repeated pattern.

Do not write  
in this space

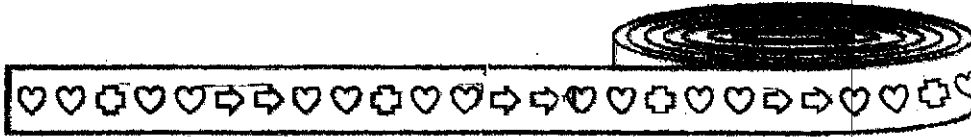

Meimei cuts a piece of tape from the roll.  
In that piece, there are 84 fewer  $\clubsuit$  than  $\heartsuit$ .  
Find the least possible total number of shapes on that piece of tape.

Ans: \_\_\_\_\_ [3]



- 9 In the figure, ABCO, EFGO and KLMO are squares.  
 Given that  $\angle KNO = 40^\circ$ , find  $\angle z$ .

Do not write  
 in this space

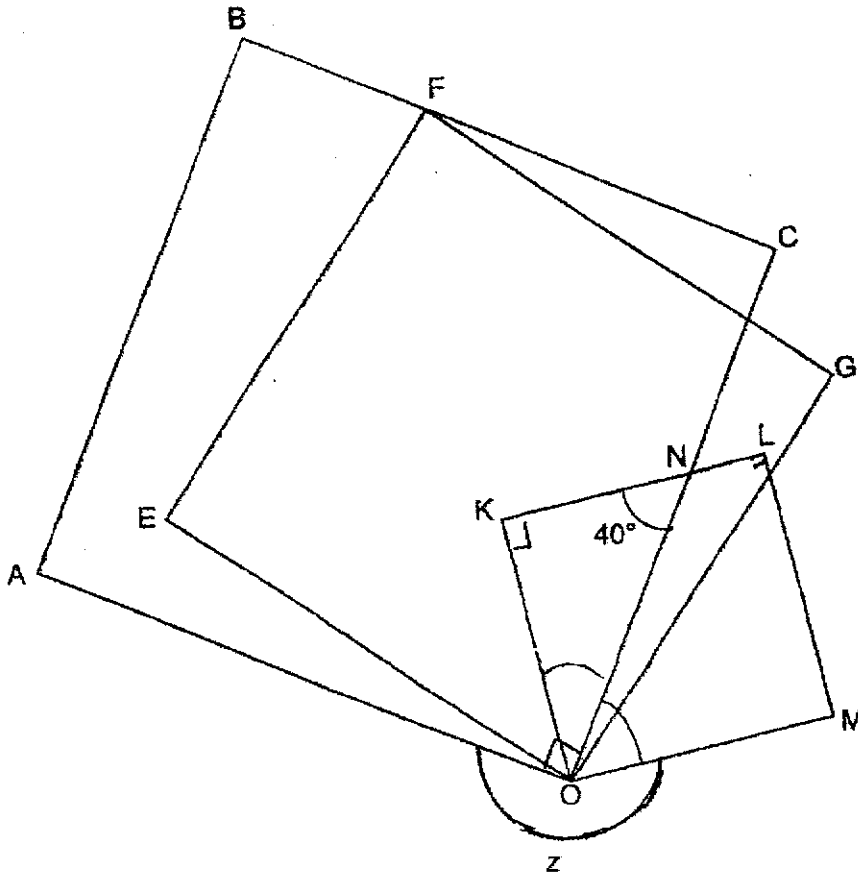

Ans: \_\_\_\_\_ [3]

- 10 Mrs Tan baked blueberry muffins and cinnamon muffins in the ratio 3 : 1. She sold 50% of all her muffins.  $\frac{5}{6}$  of the muffins sold were blueberry muffins. In the end, she had 36 cinnamon muffins left. How many blueberry muffins did she have left?

Do not write  
in this space

Ans: \_\_\_\_\_ [3]

11

A clothing store offered 120 dresses at a 20% discount during a weekday sale. The line graph shows the number of dresses left unsold at the end of each day.

Do not write  
in this space

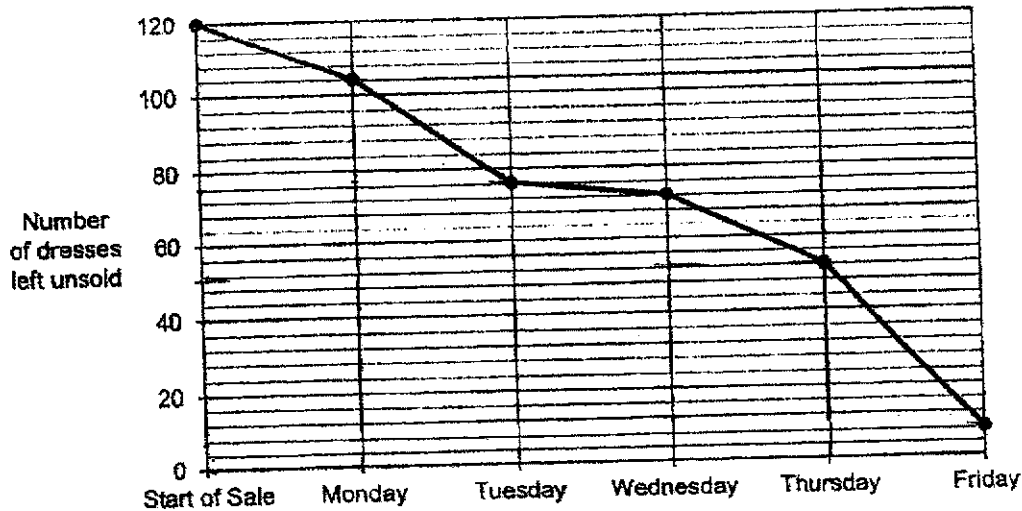

- (a) On which day was the most number of dresses sold?
- (b) The discounted price of each dress was \$60 during the sale. After the sale, the remaining dresses were sold without discount. What was the total amount of money collected from selling all 120 dresses?

Ans: (a) \_\_\_\_\_ [1]

(b) \_\_\_\_\_ [3]

12 A triangular piece of paper is folded along the dotted line as shown below. Given that  $AB = AC$ , find:

Do not write in this space

(a)  $\angle x$

(b)  $\angle y$

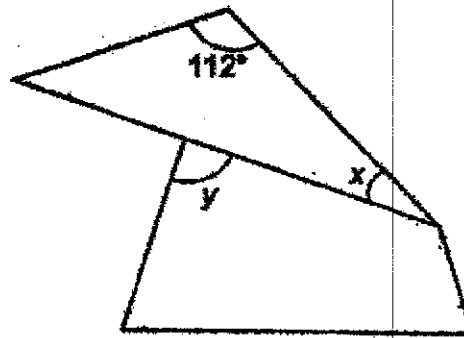
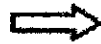
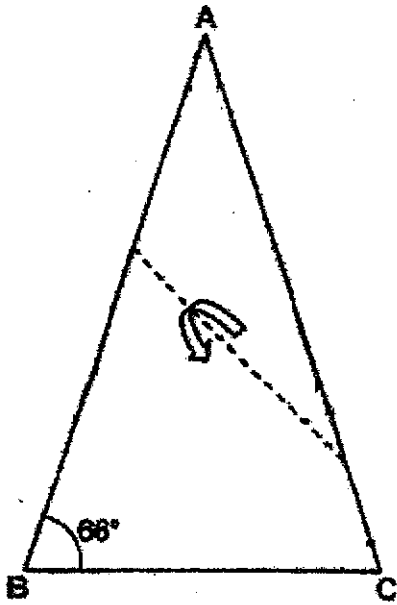

Ans: (a) \_\_\_\_\_ [2]

(b) \_\_\_\_\_ [3]



- 13 The outline of the shaded figure below is formed by quarter circles and straight lines. Find the area of the shaded figure.  
(Take  $\pi = 3.14$ )

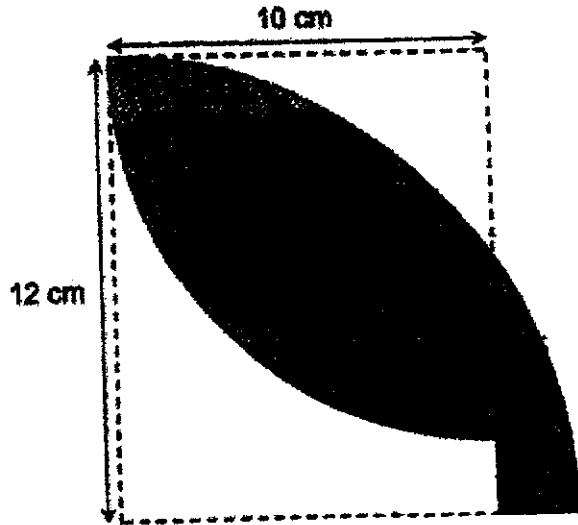

Do not write  
in this space

Ans: \_\_\_\_\_ [3]

- 14 A cuboid is shown below. The length, breadth and height are whole numbers in cm. The area of the face seen from the front view is  $126 \text{ cm}^2$ . The area of the face seen from the side view is  $135 \text{ cm}^2$ . The volume of the cuboid is less than  $5000 \text{ cm}^3$ .

Do not write in this space

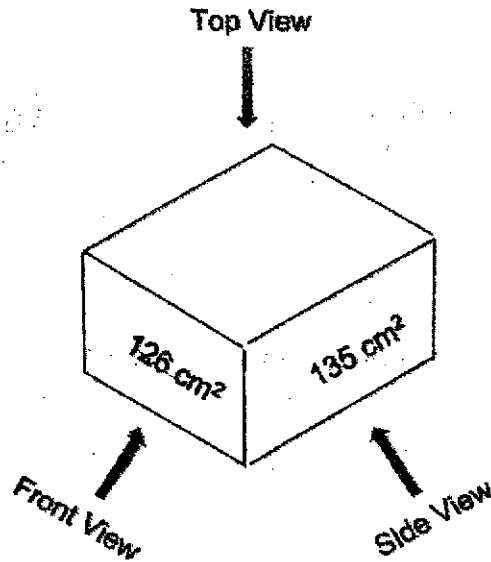

- (a) Find the area of the face seen from the top view.
- (b) Pamela painted all the faces of the cuboid. She then cut the cuboid into 1-cm cubes. How many of these cubes have 1 of the faces painted?

Ans: (a) \_\_\_\_\_ [2]

(b) \_\_\_\_\_ [2]



15 The first three figures of a pattern are shown below.

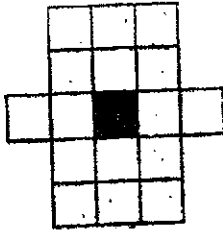

Figure 1

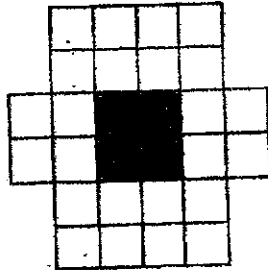

Figure 2

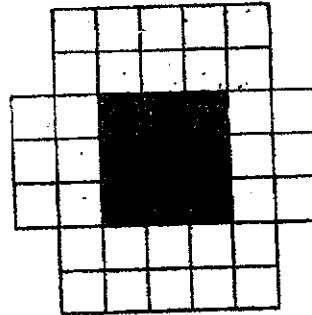

Figure 3

The table shows the number of white and grey squares used for each figure.

Figure Number	1	2	3	4
Number of white squares	16	24	32	
Number of grey squares	1	4	9	

[11]

- (a) Fill in the table for Figure 4.
- (b) How many grey squares are used for Figure 169?
- (c) Find the total number of white and grey squares in Figure 169.

Do not write  
in this space

Ans: (b) \_\_\_\_\_ [1]

(c) \_\_\_\_\_ [2]



- 16 Blue stickers were sold in packets of 15 each. Green stickers were sold in packets of 40 each. Renee bought 5 packets of blue stickers and some packets of green stickers. Fatimah bought 13 packets of blue stickers and some packets of green stickers. Both girls bought the same total number of packets of stickers.

Do not write  
in this space

- (a) How many more green stickers did Renee buy than Fatimah?
- (b) After Renee used  $\frac{3}{5}$  of her green stickers and Fatimah used half of her green stickers, they both had 452 green stickers left altogether. How many blue and green stickers did Fatimah buy altogether?

Ans: (a) \_\_\_\_\_ [1]

(b) \_\_\_\_\_ [4]

- 17 Mary decorated a rectangular piece of cardboard using stars and smiley faces. On the top part, there were 2 stars for every 9 cm of length of the cardboard. On the bottom part, there were 5 smiley faces for every 12 cm. The stars and smiley faces were placed at an equal distance apart as shown.

Do not write in this space

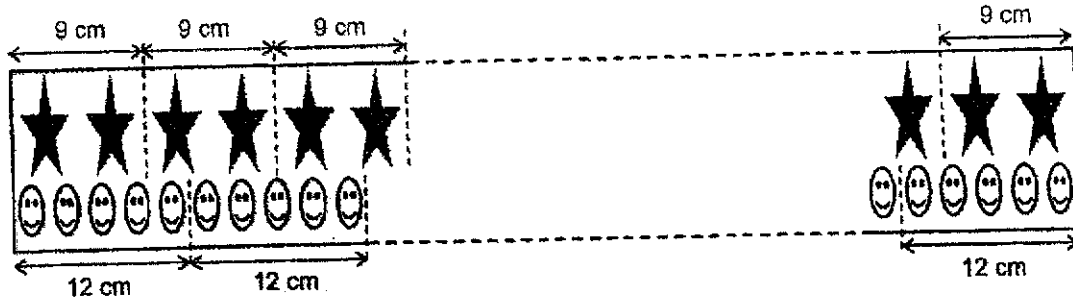

- (a) A total of 552 stars and smiley faces were used to decorate the cardboard. How many smiley faces were there?
- (b) Next, Mary wants to tie a ribbon under each smiley face as shown below. Each ribbon measures 6 cm long.

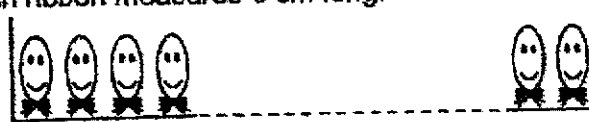

Given that ribbons were sold in rolls of 80 cm each, how many rolls of ribbons does Mary need to buy?

Ans: (a) \_\_\_\_\_ [3]

(b) \_\_\_\_\_ [2]

Setters: Mrs Tina Tan, Mrs Norah Idil, Ms Rajesheela

## ANSWER KEY

**YEAR** : 2021  
**LEVEL** : PRIMARY 6  
**SCHOOL** : HENRY PARK  
**SUBJECT** : MATHEMATICS  
**TERM** : PRELIMINARY

### BOOKLET A (PAPER 1)

Q1	4	Q2	2	Q3	3	Q4	4	Q5	2
Q6	4	Q7	2	Q8	3	Q9	1	Q10	4
Q11	3	Q12	4	Q13	2	Q14	1	Q15	2

### BOOKLET B (PAPER 1)

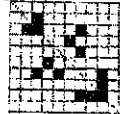
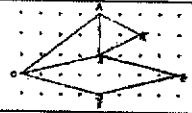
Q16	\$3.45	Q17	36
Q18	1.9%	Q19	
Q20	$30 - 20 = 10$ $40 \times 25 \times 10 = 1000 \times 10$ $= 10000\text{ml}$	Q21	$43^\circ + 90^\circ = 133^\circ$
Q22	$15 + 20 \times 3 = 15 + 60 = 75\text{s}$	Q23	$20 + 40 + 20 + 40 = 120$ $120 + 31.4 = 151.4\text{cm}$
Q24	$22 - 8 = 14(\text{mn})$ $14 - 4 = 10(\text{sn})$ S : M $10 : 14$ $5 : 7$	Q25	a) $\left(\frac{14k-4}{3}\right) \text{cm}$ b) $14 \times 8 = 112$ $112 - 4 = 108\text{cm}$
Q26	$30 \div 2 = 15$ $15 \times 20 \times \frac{1}{2} = 150\text{cm}^2$	Q27	a)b) 
Q28	$\frac{4}{5} = \frac{16}{20}$ $\frac{1}{4} = \frac{5}{20}$ ANS : $\frac{5}{16}$	Q29	D : $2.5 \times 10 = 25$ W : $2 \times 16 = 32$ M : $1.2 \times 8 = 9.6$ $9.6 + 25 + 32 = 9.6 + 57 = \$66.60$
Q30	$R \times 12 = (R-5) \times 21 - 57$ $12R = 21R - 105 - 57$ $12R = 21R - 162$ $9R = 162$		

$R = 162 \div 9 = 18$		
$18 - 5 = 13$		

**PAPER 2**

Q1	$54 \div 6 = 9$ $9 \times 3w = 27w$ $150 - 42 = 108$ $108 \div 27 = 4$	Q2	$180^\circ - 137^\circ = 43^\circ$ $180^\circ - 90^\circ - 43^\circ = 47^\circ$ $180^\circ - 47^\circ = 133^\circ$
Q3	$3 - 1 = 2$ $2 \div \frac{1}{2} = 2 \times 2 = 4$ $4 \times 3.5 = 14$ $14 + 8 = \$22$	Q4	$78 + 106 + 85 = 269$ $95 \times 4 = 380$ $380 - 269 = 111$
Q5	$70 \div 2 = 35$ $35 \times 35 \times \frac{22}{7} \times \frac{1}{2} = 1925$ (semi) $56 \times 42 \times \frac{1}{2} = 1176$ (tri) $1925 - 1176 = 749$ cm <sup>2</sup>	Q6	a) 120 b) $120 + 560 + 240 + 160$ $= 1080$ ( $\frac{3}{4}$ of student) $1080 \times \frac{4}{3} = 1440$
Q7	May : $2240 \times \frac{100}{80} = 2800$ June : $2016 \times \frac{100}{90} = 2240$ July : \$2016 ANS : \$2800	Q8	Each set : $4 - 1 = 3$ $84 \div 3 = 28$ $28 \times 7 = 196$ $196 - 2 = 194$
Q9	$180^\circ - 90^\circ - 40^\circ = 50^\circ$ $90^\circ - 50^\circ = 40^\circ$ $40^\circ + 90^\circ = 130^\circ$ $360^\circ - 130^\circ = 230^\circ$	Q10	$3u + u = 2u$ $2u = 36$ $9u - 6u = 4u$ $4u = 36 \times 2 = 72$
Q11	a) Friday b) $120 - 8 = 112$ $112 \times 60 = 6720$ $60 \times \frac{100}{80} = 75$ $75 \times 8 = 600$ $600 + 6720 = \$7320$	Q12	a) $180^\circ - 66^\circ - 66^\circ = 48^\circ$ $180^\circ - 48^\circ - 112^\circ = 20^\circ$ b) $180^\circ - 20^\circ - 20^\circ = 140^\circ$ $360^\circ - 140^\circ - 66^\circ - 66^\circ = 88^\circ$
Q13	$12 \times 10 = 120$ $10 \times 10 \times 3.14 \times \frac{1}{4} = 78.5$ $120 - 78.5 = 41.5$ $\frac{1}{4} \times 3.14 \times 12 \times 12 = 113.04$ $113.04 - 41.5 = 71.54$ cm <sup>2</sup>	Q14	a) $14 \times 15 = 210$ cm <sup>2</sup> b) $156 + 84 + 91 = 331$ $331 \times 2 = 662$
Q15	a) $32 + 8 = 40$ (white sq) $4 \times 4 = 16$ (grey sq) b) $169 \times 169 = 28561$ c) $16 + (169 - 1) \times 8$	Q16	a) $13 - 5 = 8$ $8 \times 40 = 320$ b) $4G + 128 + 5G = 452$ $9G = 452 + 28 = 324$

	$= 16 + 168 \times 8$ $= 16 + 1344$ $= 1360$ $1360 + 28561 = 29921$		$10G = 324 \times \frac{10}{9} = 360$ $13 \times 15 = 195$ $195 + 360 = 555$
Q17	<p>a) <math>864 \div 9 \times 2 = 192</math>  <math>864 \div 12 \times 5 = 360</math></p> <p>b) <math>80 \div 6 = 13R2</math>  <math>360 \div 3 = 27R9</math>  <math>27 + 1 = 28</math></p>		

3  
ENP

