

Name : _____ ()

Class : Primary 5 _____

CHIJ ST NICHOLAS GIRLS' SCHOOL**Primary 5****Term 2****Weighted Assessment****SCIENCE****BOOKLET A****12 May 2022****Total Time for Booklets A and B: 1 hour****18 questions
36 marks****Do not open this booklet until you are told to do so.
Follow all instructions carefully.****This paper consists of 13 printed pages.**

Section A (18 x 2 marks = 56 marks)

For each question from 1 to 18, four options are given. One of them is the correct answer. Make your choice (1, 2, 3 or 4). Shade the correct oval (1, 2, 3 or 4) on the Optical Answer Sheet provided.

1. Brittany conducted an experiment to find out how different temperatures can affect the growth of bacteria M. Her results are shown in the table below.

Temperature at which bacteria M is kept (°C)	Number of bacteria (unit)	
	At the start of experiment	48 hours later
30	1	150
40	1	300
50	1	200
60	1	80

Based on the results above, which one of the following statements about growth of bacteria M is true?

- (1) Bacteria grow best at cold temperatures.
 (2) Bacteria grow best at high temperatures.
 (3) Bacteria grow the best at temperatures between 35 °C to 40 °C.
 (4) Bacteria is killed completely when the temperature reach 60 °C.
2. The table below shows the characteristics of animal W and animal X. A tick (✓) shows that the characteristic is present.

Animal	Number of legs				Method of Reproduction	
	0	2	4	6	Lay eggs	Gives birth to young alive
W			✓			✓
X	✓				✓	

Which of the following shows the likely outer body coverings of animal W and animal X?

	Animal W	Animal X
(1)	hair	scales
(2)	feathers	hair
(3)	moist skin	feathers
(4)	scales	moist skin

3. Study the diagram below.

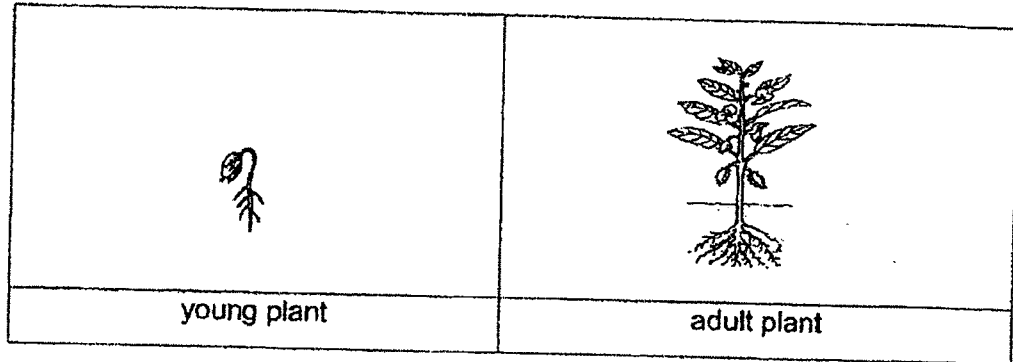

What is the similarity between the young plant and the adult plant?

- (1) They can bear fruits.
- (2) They can make their own food.
- (3) They require air, warmth and water to survive.
- (4) They can absorb water and mineral salts through their roots.

4. Laura took two cells W and X from the same plant as shown in the diagrams below.

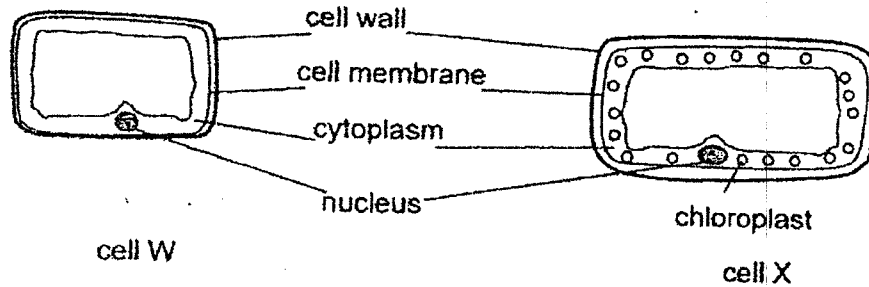

Which of the following correctly identifies the plant parts that Laura took cells W and X from?

	cell W	cell X
(1)	leaf	root
(2)	root	leaf
(3)	fruit	root
(4)	leaf	leaf

5. Which of the following shows the basic unit of life of a plant and a human?

	plant	human
(1)	cell	cell
(2)	cell wall	cell membrane
(3)	nucleus	nucleus
(4)	chloroplast	nucleus

6. Four friends made the following statements about the human circulatory system.

Amy: When we exercise, our heartbeat slows down.

Bale: The circulatory system needs to work together with the other body systems.

Cathy: Blood transports only oxygen and digested food to all parts of the body.

Drewy: The circulatory system is made up of the heart, blood and blood vessels.

Who have made the correct statements about the human circulatory system?

- (1) Amy and Bale only
- (2) Bale and Cathy only
- (3) Bale and Drewy only
- (4) Cathy and Drewy only

7. The diagram below shows the circulatory system of a fish. The arrows represent the flow of blood to the various parts of its body

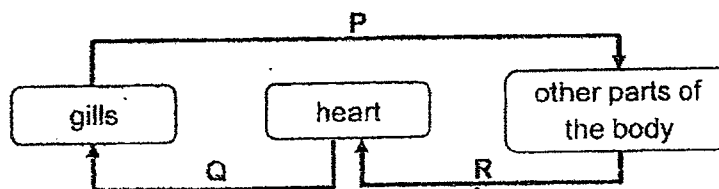

The blood flowing in blood vessel Q has _____.

- (1) more oxygen than the blood in blood vessel R
- (2) more oxygen than the blood in blood vessel P
- (3) less carbon dioxide than the blood in blood vessel R
- (4) more carbon dioxide than the blood in blood vessel P

8. Suelyn carried out three different activities. She measured her pulse rate and her breathing rate for each activity that she carried out. The results were recorded in the table below.

Activity	Pulse rate (per minute)	Breathing rate (per minute)
X	130	80
Y	80	45
Z	140	95

Based on the results above, which of the following statements are true?

- A Activity Y requires the most amount of energy.
 B More energy is needed in activity Z than in activity X.
 C Higher pulse rate allows a higher gaseous exchange rate.
 D Her pulse rate decreased but her breathing rate increased when she was exercising.
- (1) A and D only
 (2) B and C only
 (3) A, C and D only
 (4) B, C and D only

9. Megan measured the mass of four pieces of cloth made of different materials E, F, G and H. She then soaked the four pieces of cloth into a pail of water and measured their mass again. The results are shown in the table below.

Material	Mass of materials (g)	
	Before soaking in water	After soaking in water
E	90	90
F	80	190
G	100	200
H	130	180

Based on the results above, which material E, F, G or H should she use to make a raincoat?

- (1) Material E
 (2) Material F
 (3) Material G
 (4) Material H

10. Leticia bought an inflatable swimming float as shown.

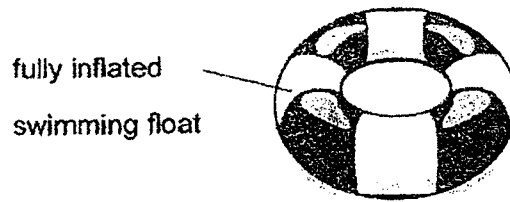

When she blew more air into the float, she observed that the size of the float remained the same.

Which of the following best explains her observation?

- (1) Air has mass.
 - (2) Air takes up space.
 - (3) Air can be compressed.
 - (4) Air has no definite shape.
11. Jiayi had two similar cans of condensed milk X and Y. She pierced two similar-sized holes in can X and only one in can Y. She tilted both cans to pour the milk out as shown in the diagram below.

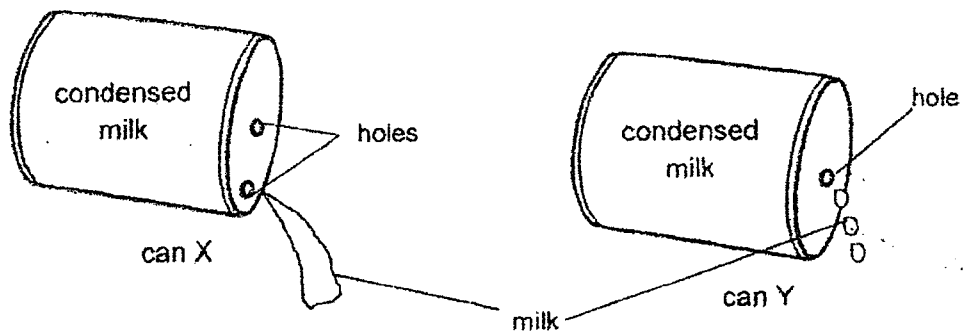

Jiayi observed that the milk flowed out of can X more easily than from can Y. Which of the following best explains this observation?

- (1) Air is able to enter can X.
- (2) The hole in can Y is too small.
- (3) Air could not escape from can Y.
- (4) The milk in can X has expanded.

12. Marianne set up an experiment in a dark room. She shone a torch on a ball as shown in the diagram below. A shadow of the ball was cast on the screen.

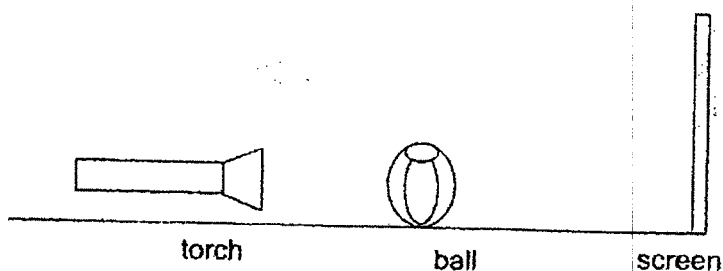

What could Marianne do to cast a bigger shadow on the screen?

- A Move the torch towards the ball.
 - B Move the screen towards the ball.
 - C Move the torch further away from the ball.
 - D Move the ball further away from the torch.
- (1) A only
(2) B and C only
(3) C and D only
(4) B, C and D only

13. The diagram below shows three sheets of materials of different shapes.

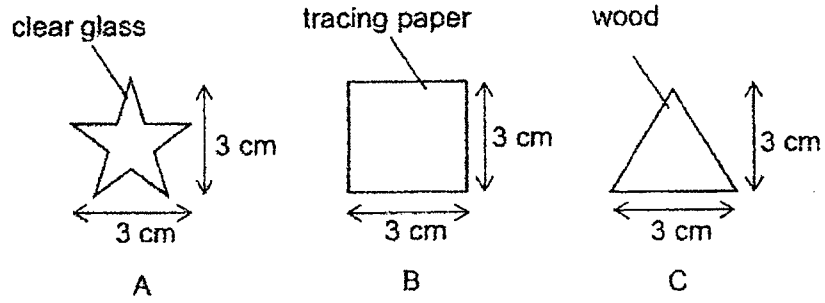

The three sheets of materials are arranged between a torch and a screen as shown below.

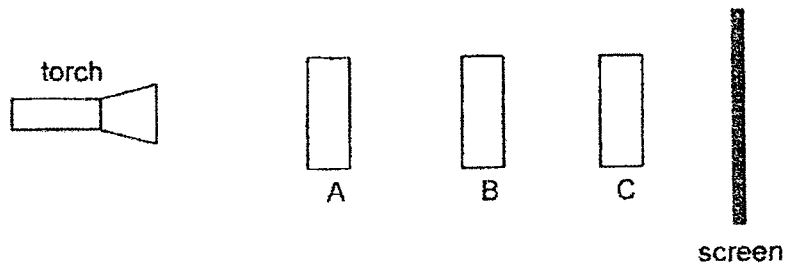

Which one of the following correctly shows the shadow formed on the screen?

(1)

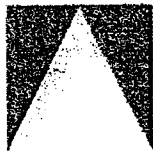

(2)



(3)



(4)



14. Benny heated some tap water until it boiled before allowing it to cool down. He recorded the temperature of the water at regular intervals. He then plotted a graph to show the changes in temperature of the water over time.

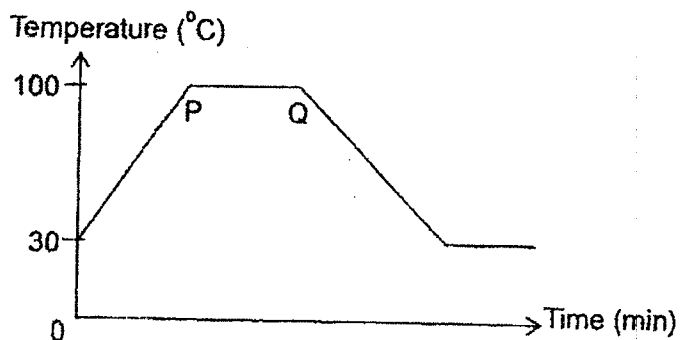

Which of the following statements about line PQ are true?

- A Heating has stopped.
 - B The water was boiling
 - C The water was still gaining heat from the flame.
 - D The temperature of water was constant as it is losing heat to the surroundings.
- (1) A and B only
(2) A and D only
(3) B and C only
(4) B, C and D only

15. The diagram below shows a square metal frame with four identical drops of wax attached at positions P, Q, R and S.

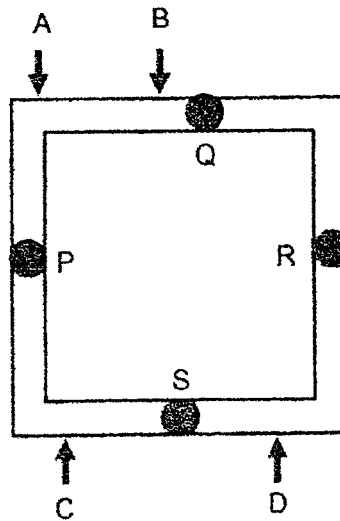

James heated the metal frame strongly at one of the points A, B, C or D. He recorded the time taken for the drops of wax to start melting in the table below.

Position of the drop of wax	Time taken for the wax to start melting (s)
P	25
Q	30
R	20
S	8

At which point A, B, C or D did James heat the square metal frame?

- (1) A
- (2) B
- (3) C
- (4) D

16. Karen set up a circuit with the switches S1, S2, S3 and S4 as shown below. All the five bulbs were lit when all four switches were closed.

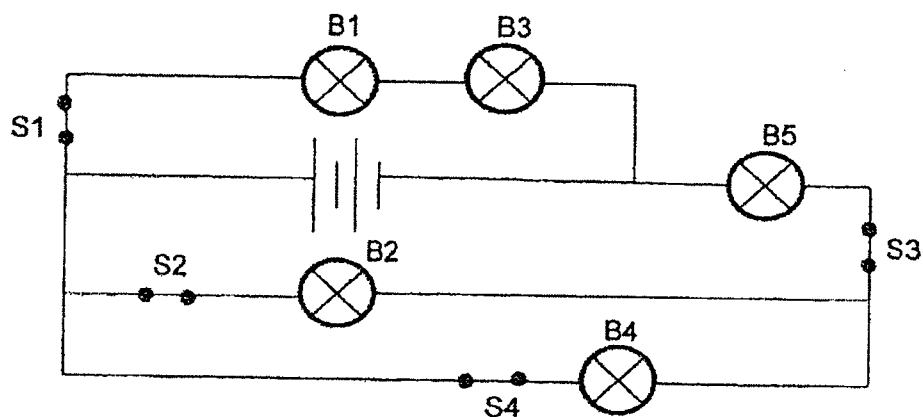

Karen wanted to have the least number of bulbs lit when one of the switch is opened. Which switch should Karen open?

- (1) S1
- (2) S2
- (3) S3
- (4) S4

17. The diagram below shows a circuit card and a circuit tester.

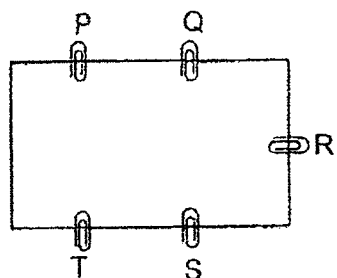

circuit card

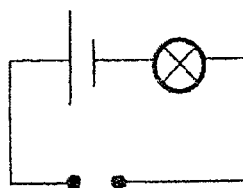

circuit tester

The table below shows what happens to the bulb when the circuit tester is connected to the circuit card.

Points connected to the circuit tester	Did the bulb light up?
P and S	yes
Q and P	no
R and T	yes
S and Q	no

Based on the results above, which of the following shows the correct arrangement of the wires on the circuit card?

(1)

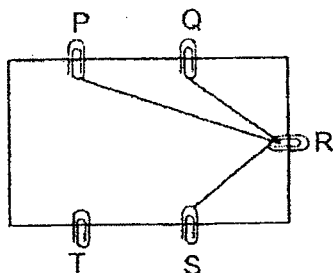

(2)

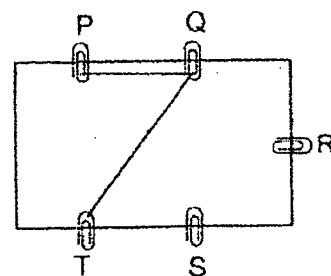

(3)

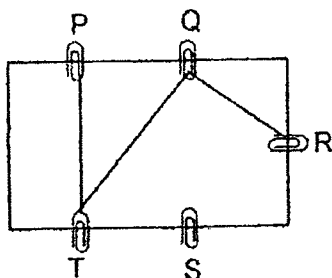

(4)

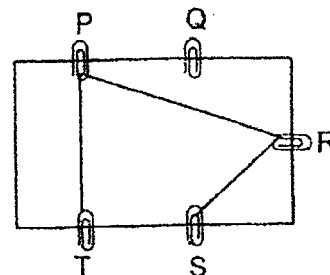

18. Jenny placed a steel clip between two set-ups A and B as shown in the diagram below.

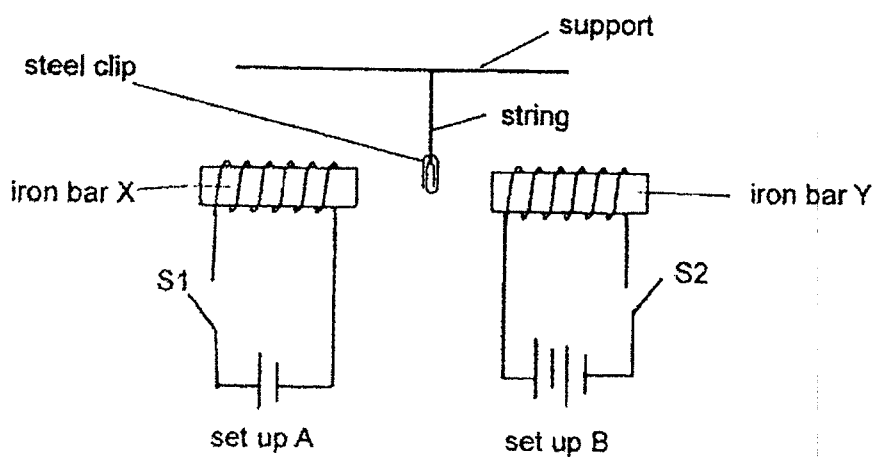

Jenny closed switches S1 and S2 at the same time, which one of the following observations would she make?

The steel clip would _____.

- (1) be attracted to the iron bar X
- (2) be attracted to the iron bar Y
- (3) remain in its original position
- (4) be attracted to the iron bar Y and then to the iron bar X

END OF BOOKLET A

Name: _____ ()

Class: Primary 5 _____

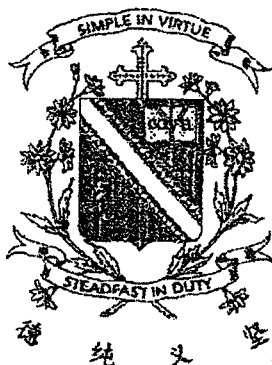
CHIJ ST NICHOLAS GIRLS' SCHOOL**Primary 5****Term 2****Weighted Assessment****SCIENCE****BOOKLET B****12 May 2022****Total Time for Booklets A and B: 1 hour****5 questions
14 marks****Do not open this booklet until you are told to do so.
Follow all instructions carefully.
Answer all questions.****This paper consists of 6 printed pages.**

Booklet A	36
Booklet B	14
Total	50

Section B (14 marks)

For questions 19 to 23, write your answers in this booklet.

The number of marks available is shown in the brackets [] at the end of each question or part question.

19. The graphs below show how Jane's heart rate and volume of blood supplied to two parts of her body changed over time as she was exercising.

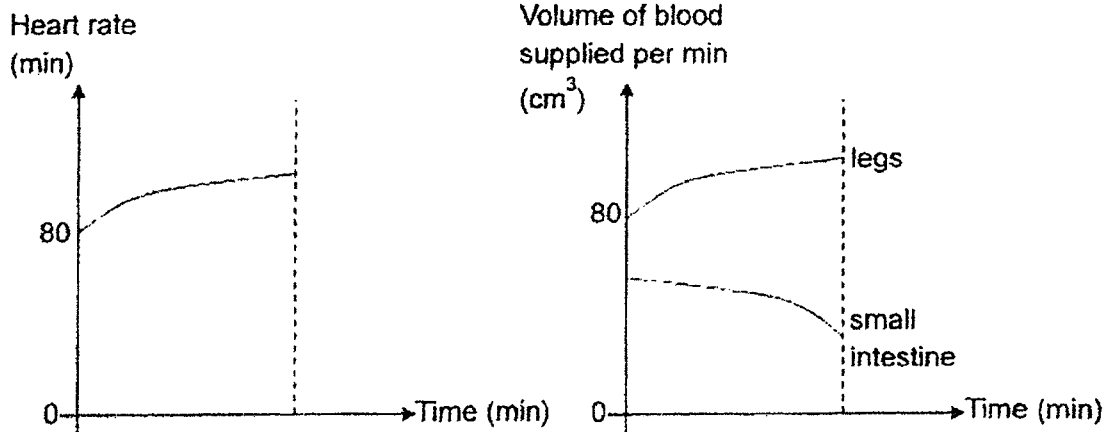

- (a) Jane observed that both her heart rate and volume of blood supplied to her legs [2] increased over time. Based on the graph above, explain this observation.

- (b) Jane's mother advises her that she should not eat right before she exercises. Based [1] on the results above, explain why her mother said so.

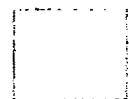

20. Benny carried out an experiment with board A as shown below. He added a 100g weight on board A and continue to add more 100g weights until it breaks. He then recorded the number of 100g weights ~~block~~ board A could hold.

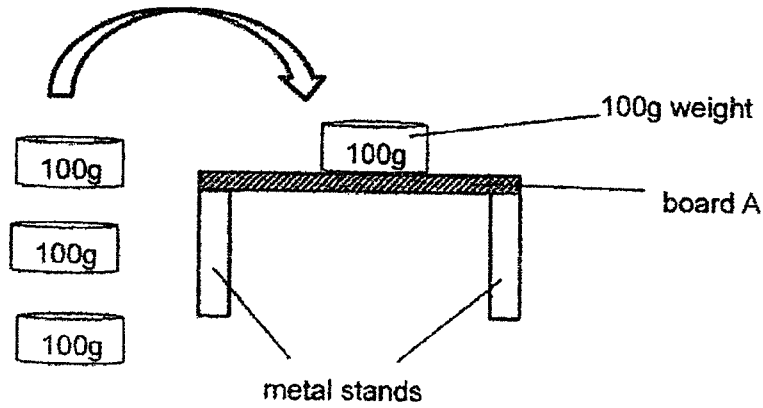

Benny repeated the experiment with 2 other boards B and C of different materials. The results are shown in the table below.

Board	Number of 100g weights needed to break the board
A	3
B	5
C	7

- (a) Which of the following variables are kept the same in his experiment? Put a tick (✓) beside the variable(s). [1]

Variable	Kept the same
Length of each board	
Number of 100g weights	
Position of metal stands	
Type of materials the board are made of	
Position where the 100g weights are placed on the boards	

- (b) What can Benny do to check if the results of his experiment are reliable? [1]



21. Linda placed three similar ice cubes on three different materials P, Q and R as shown below. The materials were of the similar size.

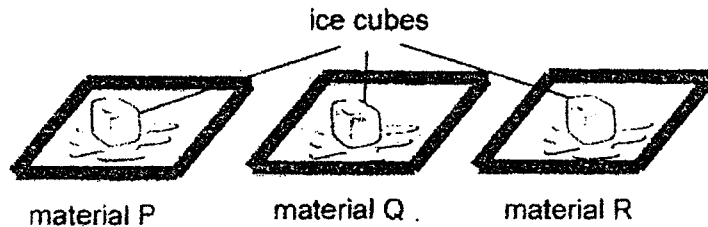

She measured the time taken for the ice cubes to melt completely when placed on the materials. She then recorded the results in a bar graph as shown below.

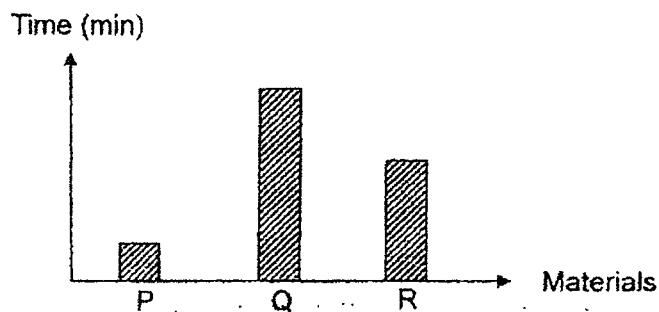

- (a) Arrange the materials according to their heat conductivity from the best conductor of heat to the poorest conductor of heat. [1]

best conductor of heat \longrightarrow poorest conductor of heat

- (b) Linda wants to use a tray to quickly defrost the fish that she took out from the freezer. [2]
Based on her experiment, which material P, Q or R should she use to make the tray?
Explain your answer.
-
-

22. Electrical supply to our homes comes from a power station. The diagram below shows two electric circuits X and Y connecting different electrical appliances to the power supply.

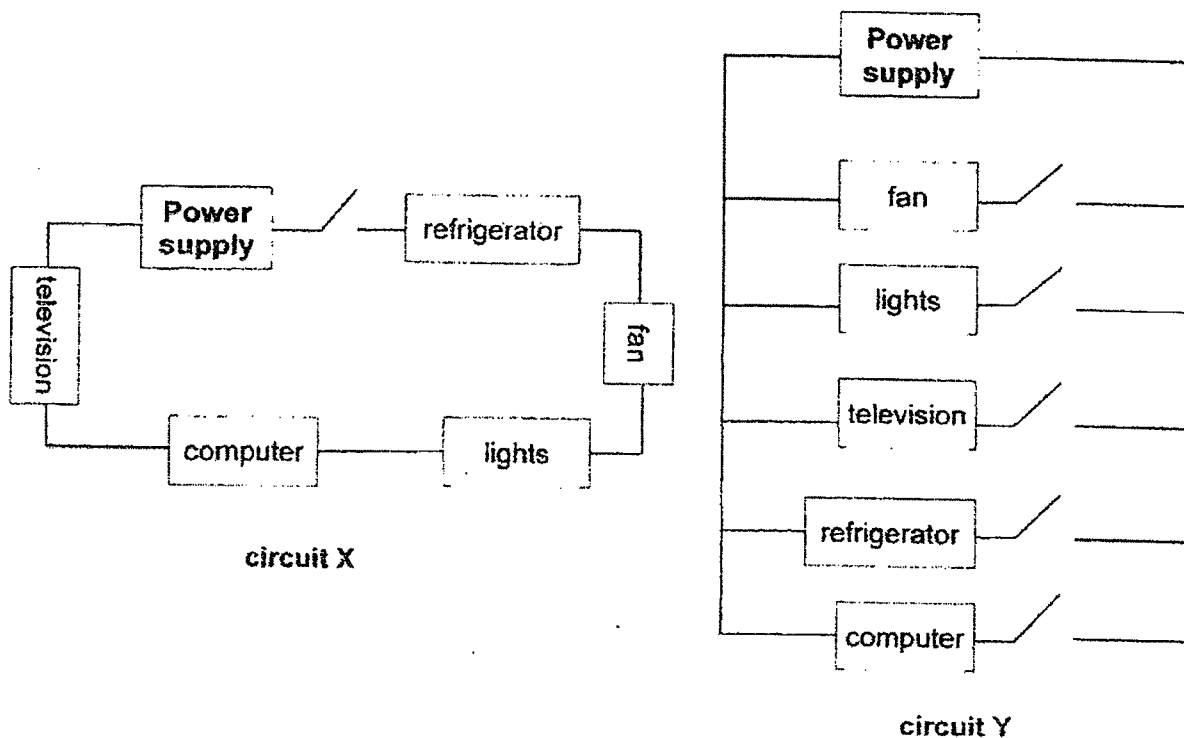

- (a) State how the electrical appliances are connected to each other in circuits X and Y. [1]

Circuit X: _____

Circuit Y: _____

- (b) Which circuit X or Y, best represents the circuit connection in a typical home? Explain your answer [2]



23. Study the diagram below.

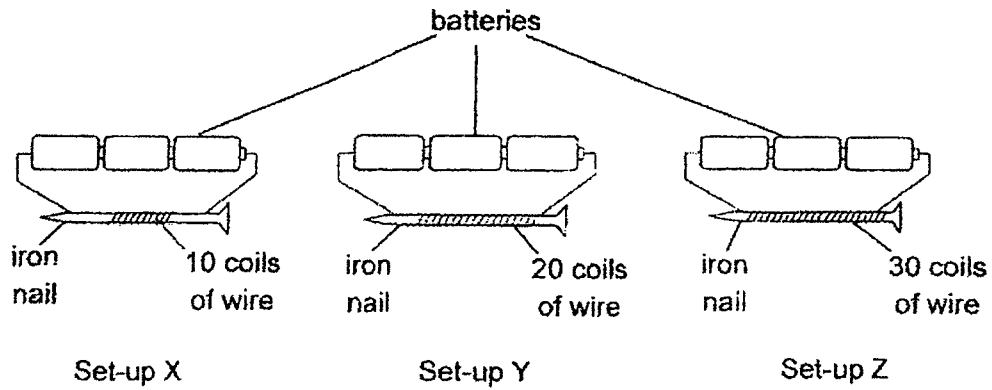

(a) Give a reason why the iron nail is suitable for use in the set-ups above. [1]

(b) Give a reason why the number of batteries must be the same in all three set-ups. [1]

(c) Wayne wanted to find out if the number of batteries will affect the strength of the electromagnet. What two changes should he made to the set-ups above? [1]

(i) Change 1:

(ii) Change 2:

~ End of Booklet B ~

ANSWER KEY

YEAR : 2022
 LEVEL : Primary 5
 SCHOOL : CHIJ ST NICHOLAS GIRLS' SCHOOL
 SUBJECT : SCIENCE
 TERM : Term 2 WA

Booklet A

Q1	3	Q2	1	Q3	4	Q4	2	Q5	1
Q6	3	Q7	4	Q8	2	Q9	1	Q10	3
Q11	1	Q12	1	Q13	4	Q14	3	Q15	4
Q16	3	Q17	4	Q18	2				

Booklet B

Q19	<p>(a) Jane could have performed a vigorous activity. When she exercises, her body needs more energy. So her heart will beat faster to pump more blood containing more digested food, oxygen and water faster for more respiration.</p> <p>(b) There is lesser amount of blood supplied to the small intestine when she exercises so lesser amount of digested food will be absorbed into the bloodstream.</p>
Q20	<p>(a) Tick : Length of each board Position metal stands Position where the 100g weights are placed on the boards</p> <p>(b) He can repeat the experiment a few more times and calculate the average of the results.</p>
Q21	<p>(a) P → R → Q</p> <p>(b) P. On tray P, the ice cubes took the shortest time to melt which shows that P is the best heat conductor hence the frozen fish will gain the most heat the fastest from tray P so, the frozen fish will defrost the fastest on P.</p>
Q22	<p>(a) Circuit X : connected in series Circuit Y : connected in parallel</p> <p>(b) Y. When one of the electrical appliances is faulty, the other appliances can still work as electricity can still flow through the other parts of the circuits. Also there are individual switches controlling each appliance thus we can save electricity as not all appliances will be switched on at the same time.</p>

Q23	<p>(a) Iron is a magnetic material and can be magnetised into a temporary magnet.</p> <p>(b) To ensure that there will be only one changed variable which is the number of coils of wire around the iron nail so that the test is fair.</p> <p>(c) (i) Change 1 : Use the same number of coils of wire around the iron nail for all 3 set-ups.</p> <p>(ii) Change 2 : Use a different number of batteries in each set-up.</p>
-----	---

2
END