



MAHA BODHI SCHOOL
2022 SEMESTRAL ASSESSMENT 2
PRIMARY FIVE SCIENCE
(BOOKLET A)

Name : _____ ()

Class : Primary 5 _____

Date : 31 Oct 2022

Total Duration for Booklets A and B: 1 h 45 min

INSTRUCTIONS TO CANDIDATES:

1. Do not turn over this page until you are told to do so.
2. Follow all instructions carefully.
3. Answer all questions.
4. Shade your answers in the Optical Answer Sheet (OAS) provided.

This booklet consists of 22 printed pages.

BLANK PAGE

BOOKLET A : [28 x 2 marks = 56 marks]

For each question from 1 to 28, four options are given. One of them is the correct answer. Make your choice (1, 2, 3 or 4). Shade your answer on the Optical Answer Sheet.

1. The diagram below shows a cell.

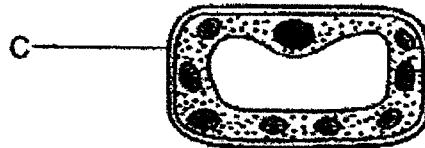

Which of the following statements is correct about part C of this cell?

- (1) It controls all the activities in the cell.
 - (2) It supports and gives the cell its shape.
 - (3) It is where cell activities take place in the cell.
 - (4) It contains information passed from parents to their young.
2. The diagram below shows two cells, X and Y.

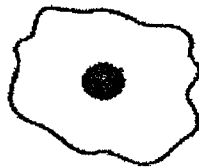

Cell X

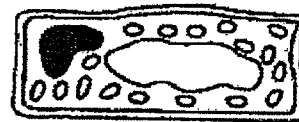

Cell Y

Which of the following statements about these cells is/are correct?

- A. Cells X and Y are found in plants.
 - B. Cells X and Y have fixed shape.
 - C. Cell Y can trap light energy but Cell X cannot.
 - D. Cell X can reproduce on its own but Cell Y cannot.
- (1) C only
 - (2) A and B only
 - (3) C and D only
 - (4) A, B and D only

3. Which of the following is a function of the human circulatory system?
- (1) protects organs in the body
 - (2) protects the muscular system
 - (3) carries substances around the body
 - (4) exchange gases with the surroundings
4. Which of the following statements about the air we breathe out is correct?
- (1) It is less warm than the air that we breathe in.
 - (2) It has less oxygen than the air that we breathe in.
 - (3) It has less water vapour than the air that we breathe in.
 - (4) It has lesser carbon dioxide than the air that we breathe in.
5. The diagram below shows how water and food are transported to and from different parts, A, B, C and D, of a plant.

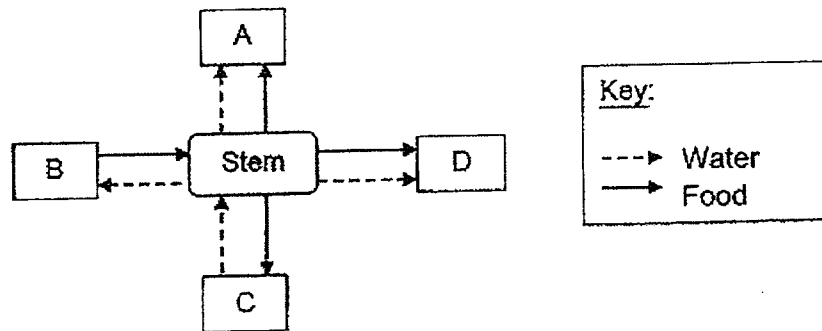

Which of the following correctly shows the parts of a plant that A, B, C and D represent?

	A	B	C	D
(1)	fruits	roots	flowers	leaves
(2)	fruits	leaves	roots	flowers
(3)	roots	leaves	fruits	flowers
(4)	leaves	flowers	roots	fruits

6. Study the fruit shown below.

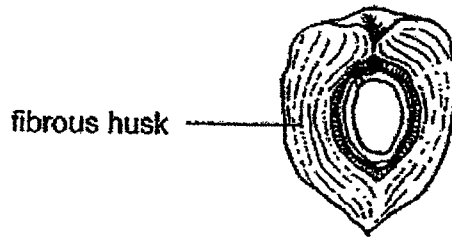

How is the seed in the fruit above dispersed?

- (1) by wind
- (2) by water
- (3) by animals
- (4) by splitting

7. The flow chart below is used to identify the different parts of the human reproductive system.

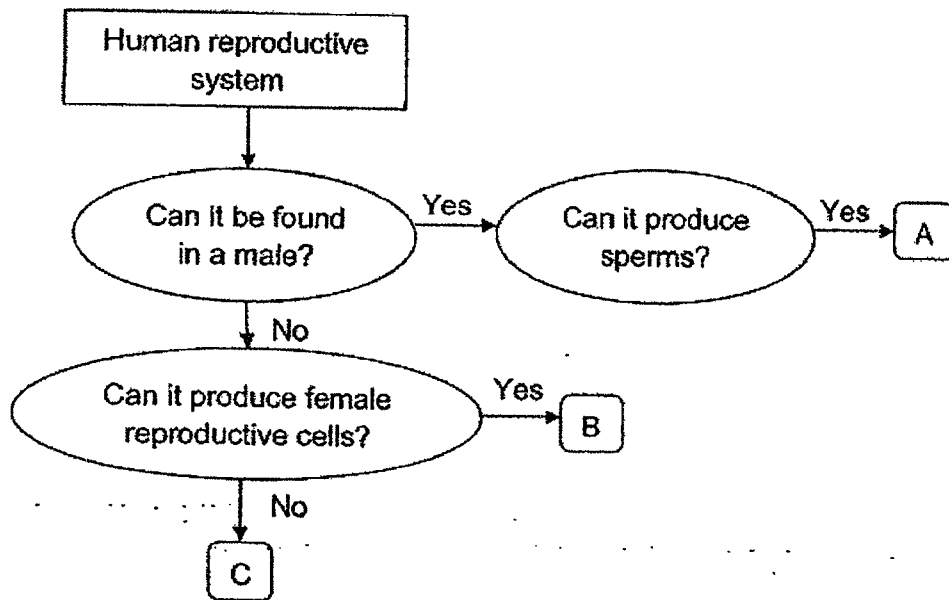

What are parts A, B and C?

	A	B	C
(1)	penis	egg	womb
(2)	penis	ovary	vagina
(3)	testes	egg	ovary
(4)	testes	ovary	womb

8. Which of the following show the similarity in the reproduction of flowering plants and humans?
- A. Pollination must occur before fertilisation.
 - B. Both involve the production of male and female reproductive cells.
 - C. Fertilisation occurs when the male reproductive cell fuses with an egg cell.
 - D. The male reproductive cell travels down the style to meet the egg cell in the ovary.
- (1) A and B only
 - (2) B and C only
 - (3) B, C and D only
 - (4) A, B, C and D

9. The table below shows some information about two animals, Q and P.

Characteristics	Animal Q	Animal P
the young resembles the adult	No	No
3-stage life cycle	No	Yes
spends part of its life cycle in water	Yes	Yes

Which of the following correctly shows what Animal Q and Animal P could represent?

	Animal Q	Animal P
(1)	butterfly	frog
(2)	butterfly	cockroach
(3)	cockroach	mosquito
(4)	mosquito	frog

10. Mr Lim carried out an experiment by placing two different cells, M and N, in separate dishes containing water and equal amounts of two substances, S and T. Cells, M and N, could expand when water and other substances entered them. The diagrams below show the observations made at the beginning and end of the experiment.

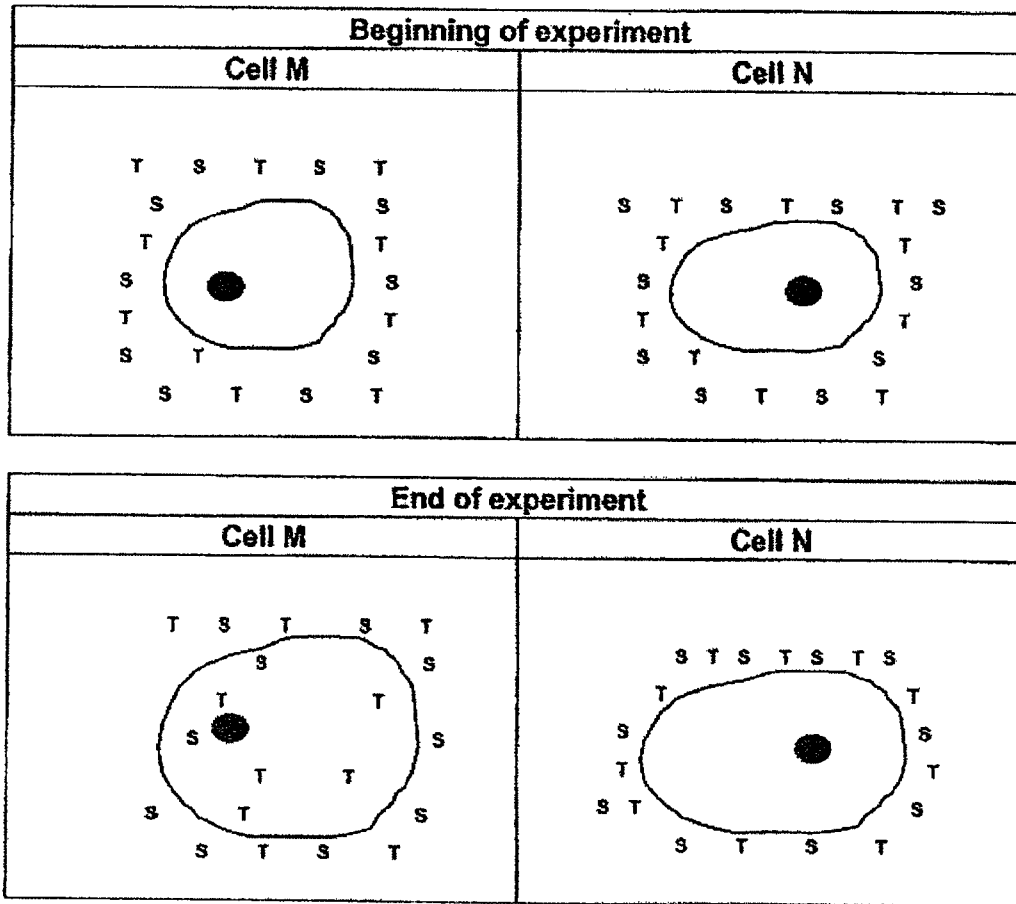

Cell M and Cell N were bigger at the end of the experiment.

Which of the following statements are correct?

- A. Only Cell M had a cell membrane.
 - B. The cell membrane of Cell N allowed water to enter.
 - C. The cell wall of Cell N prevented the substances from entering.
 - D. The cell membrane controlled the substances entering the cells.
- (1) A and C only
 (2) B and C only
 (3) B and D only
 (4) A, C and D only

11. The cross sections of the stem of plants A and B are shown below.

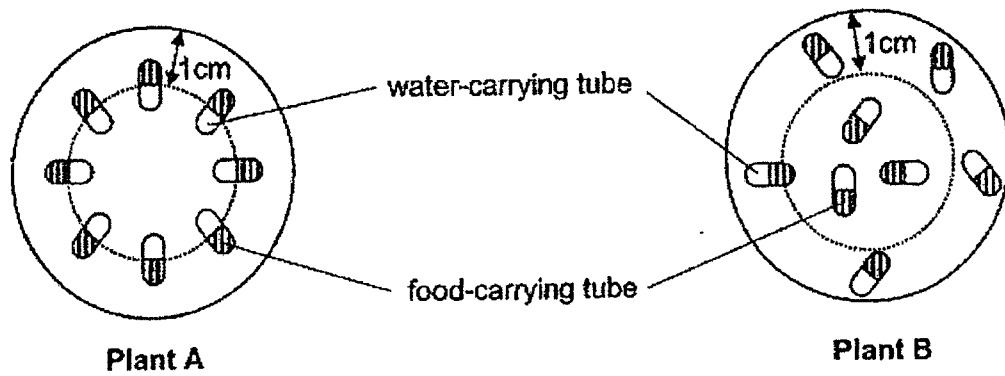

Gary removed 1cm around each stem and put the plants into beakers of water. The amount of water in each container is the same at the start of the experiment.

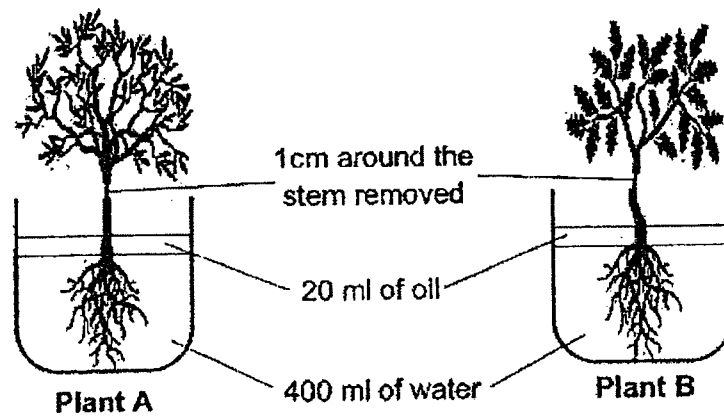

Which of the following would he likely to observe after 5 days?

	Amount of water left in container with plant A (ml)	Amount of water left in container with plant B (ml)
(1)	350	350
(2)	350	370
(3)	370	350
(4)	400	400

12. Joyce wanted to find out if light is required for seeds to germinate. She placed same number of seeds into each container at the same place as shown below.

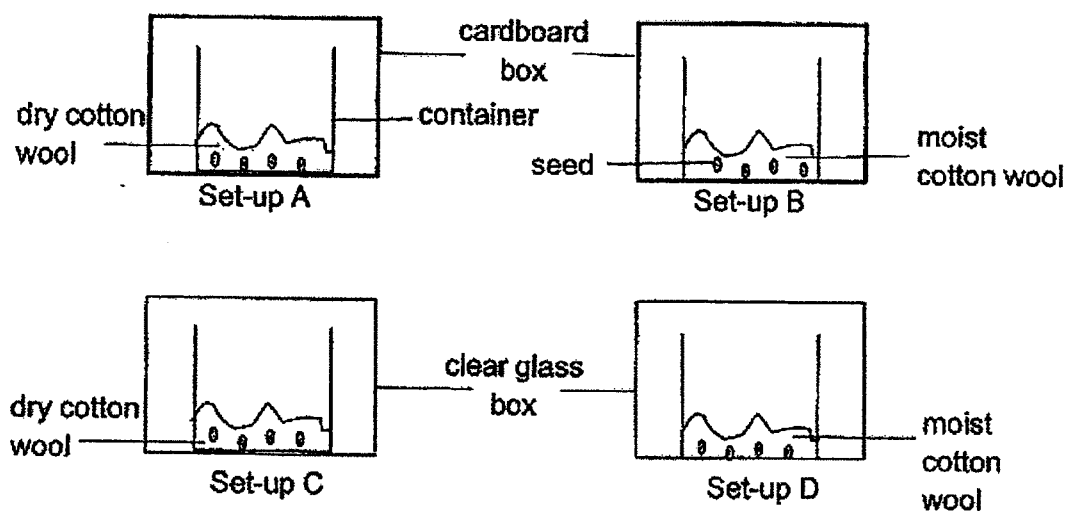

Which two set-ups should she use to ensure that it was a fair test?

- (1) A and B
- (2) A and C
- (3) B and D
- (4) C and D

13. Look at the diagrams below.

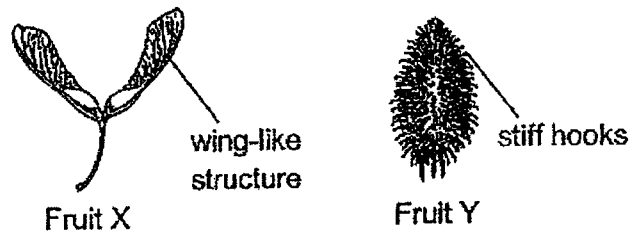

Which of the following graphs shows the relationship between the distance fruits X and Y are dispersed from their parent plants and the amount of wind present?

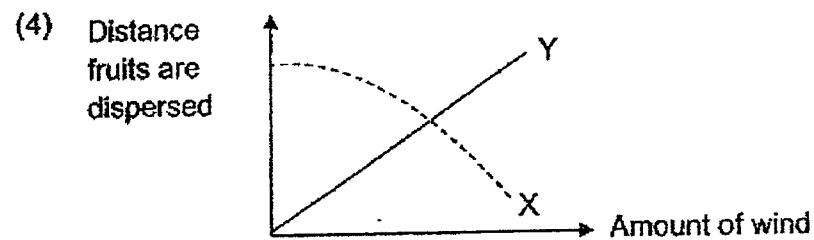
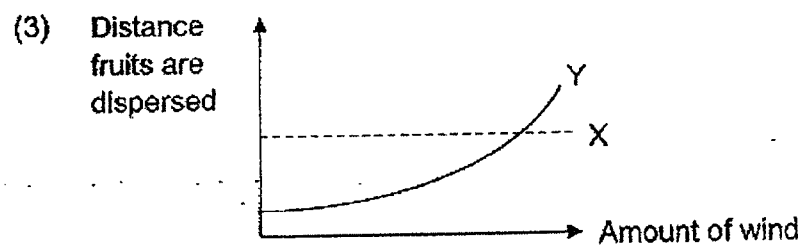
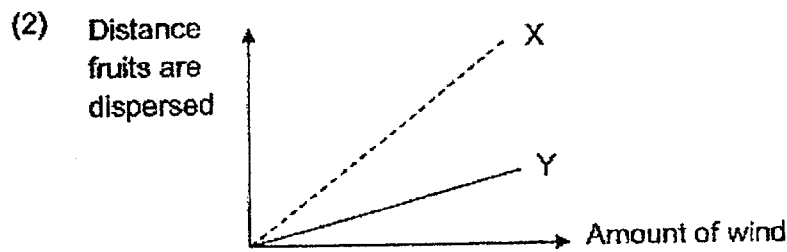
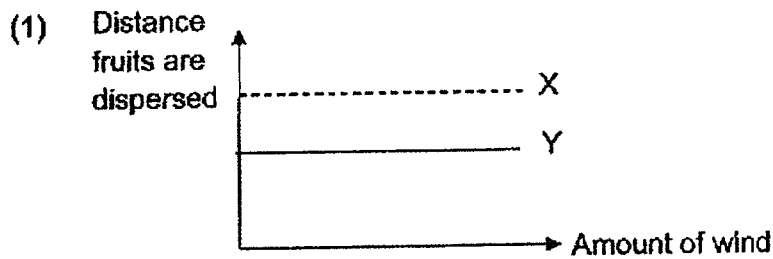

14. The diagram below shows a young plant growing in some soil. This plant is watered daily.

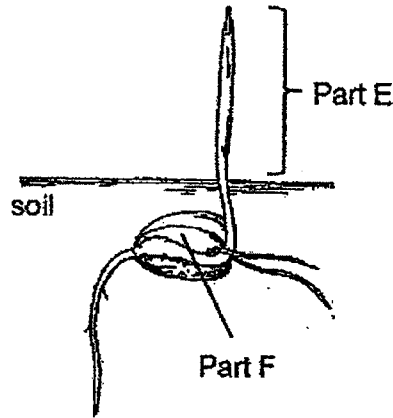

As the young plant grows, parts E and F change in mass.

Which of the following graphs shows correctly the change in the mass of parts E and F over a period of 1 week?

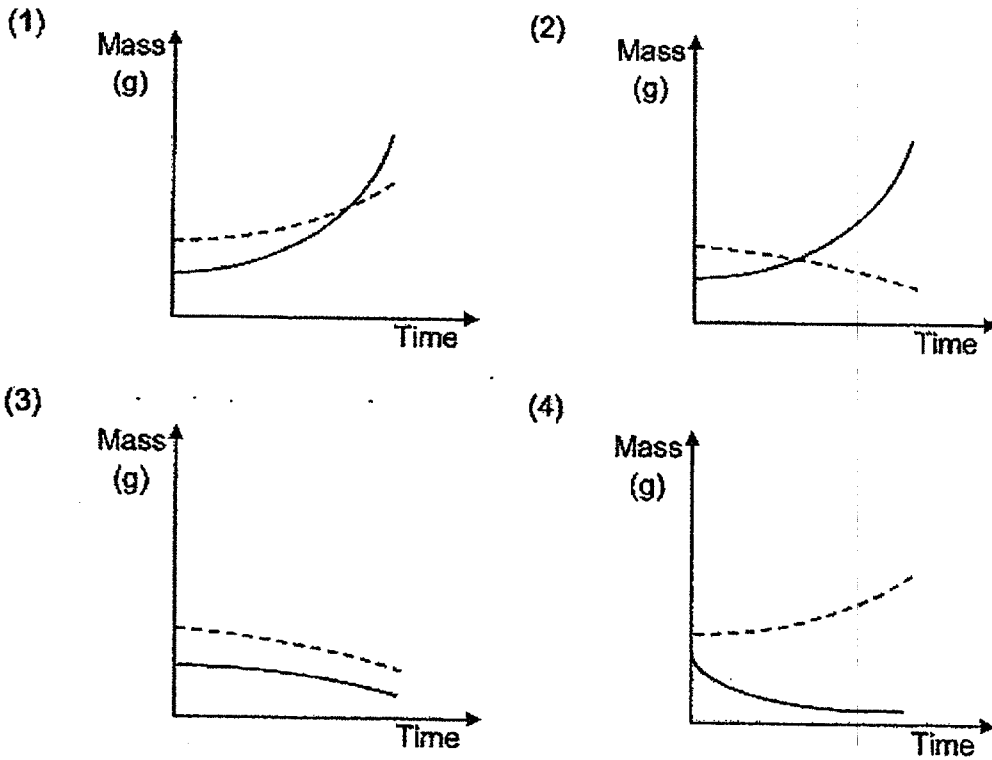
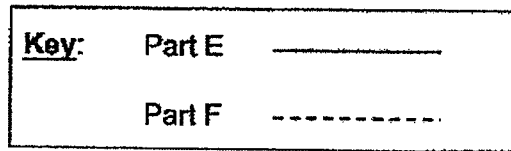

15. The diagrams below show four different systems in Ming Wei's body.

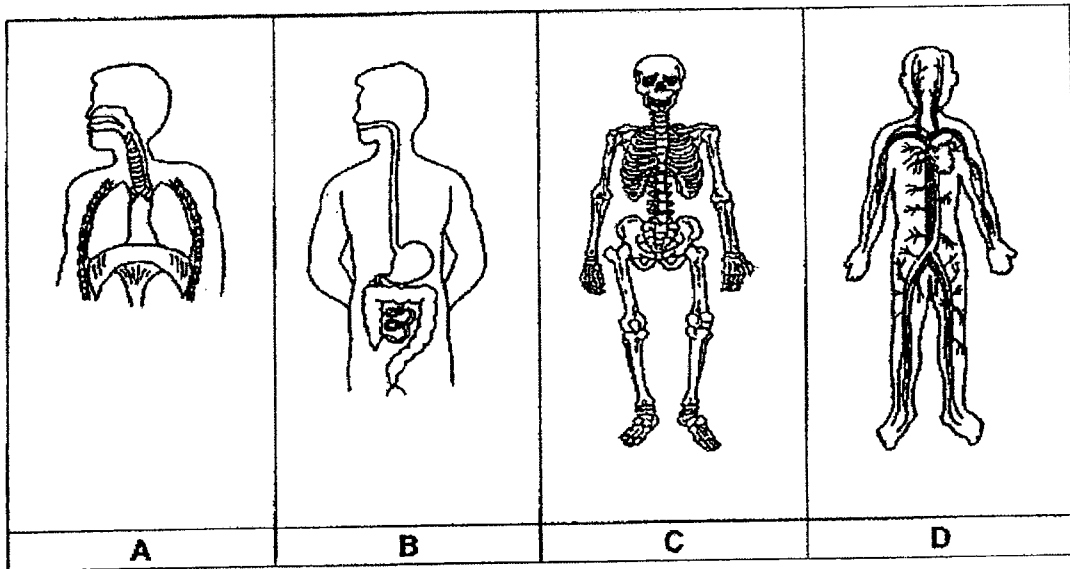

Ming Wei is taking part in a running race. Which of the systems enable Ming Wei to obtain more energy when he starts running?

- (1) A and C only
- (2) B and D only
- (3) A, C and D only
- (4) A, B and D only

16. The diagram below shows the water cycle. X and Y represent different processes in the water cycle.

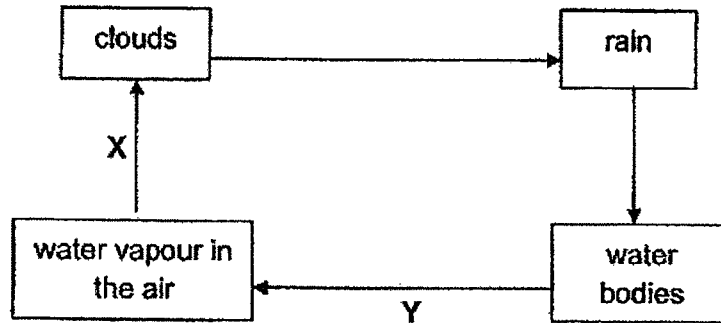

Which of the following correctly shows the gain or loss of heat during processes, X and Y?

	X	Y
(1)	heat is lost by the water vapour	heat is gained by the water
(2)	heat is gained by the water vapour	heat is lost by the water
(3)	heat is lost by the water vapour	heat is lost by the water
(4)	heat is gained by the water vapour	heat is gained by the water

17. Amos left three cubes of ice of different sizes on the dining table at the same time.



ice cube P

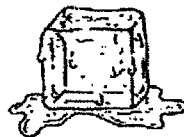

ice cube Q

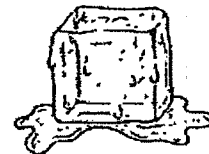

ice cube R

Which one of the following statements about the melting ice cubes is true?

- A. Ice cube P had the lowest temperature.
 - B. The time taken to melt the ice cubes was the same.
 - C. All the ice cubes would have a temperature of more than 0°C.
 - D. Ice cube R required more heat to melt completely than ice cube Q.
- (1) B only
 (2) D only
 (3) A and B only
 (4) C and D only

18. Sam carried out an experiment using a circuit tester, as shown in the diagram, to find out which materials A, B, C and D are electrical conductors.

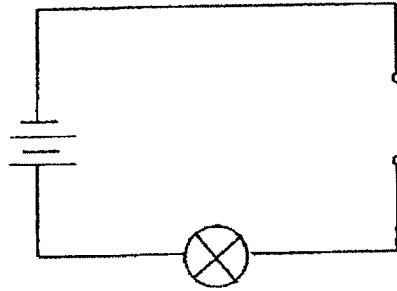

The results are recorded in the table below.

Material	Bulb lighted up	Bulb did not light up
A	✓	
B	✓	
C	✓	
D		✓

Which of the following correctly represents materials A, B, C and D?

	Material A	Material B	Material C	Material D
(1)	copper	iron	rubber	cotton
(2)	gold	cardboard	copper	wood
(3)	aluminum	steel	styrofoam	ceramic
(4)	steel	gold	iron	styrofoam

19. Two pieces of unknown metals, X and Y, and a bar magnet are hung from a support as shown below.

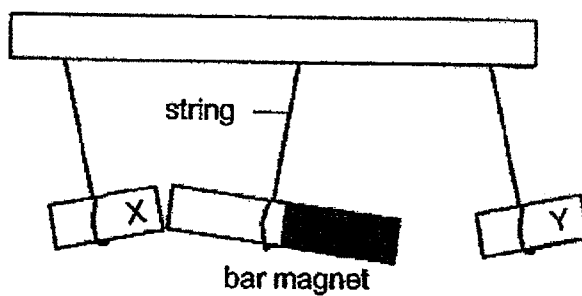

Which of the following is definitely true about X or Y?

- (1) X is a magnet.
- (2) Y is a magnet.
- (3) Y is made of silver.
- (4) X is made of copper.

20. Jenny had 3 containers, A, B and C, made of the same material but of different size. They were filled with the same amount of water. Container A was covered with a plastic lid while the other 2 containers, B and C, were left uncovered. She left the three containers in the Parade Square on a hot and sunny day.

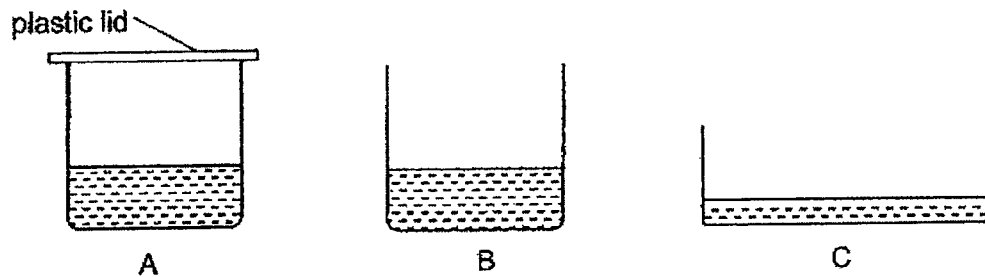

Which of the following graphs correctly shows the change in the amount of water in the containers?

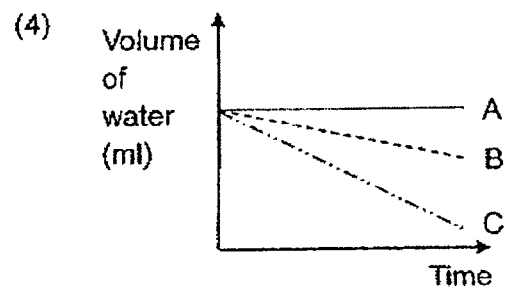
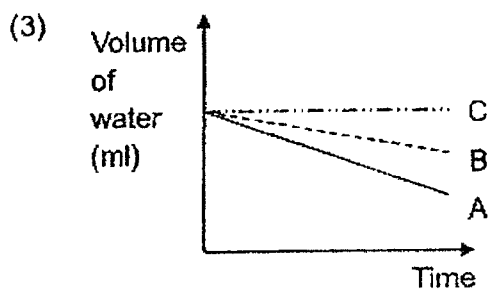
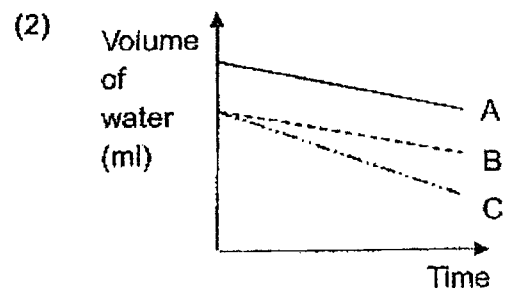
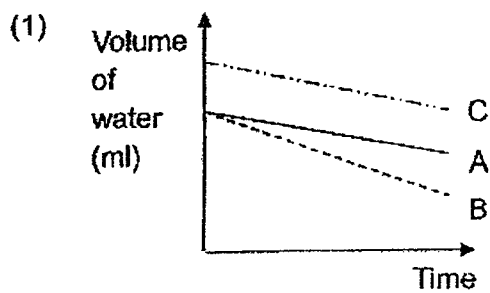

21. Sophie placed 100 cm^3 of boiling water into 2 containers, A and B. She then placed some ice cubes into container B before measuring the temperature of the water of both containers for 3 hours.

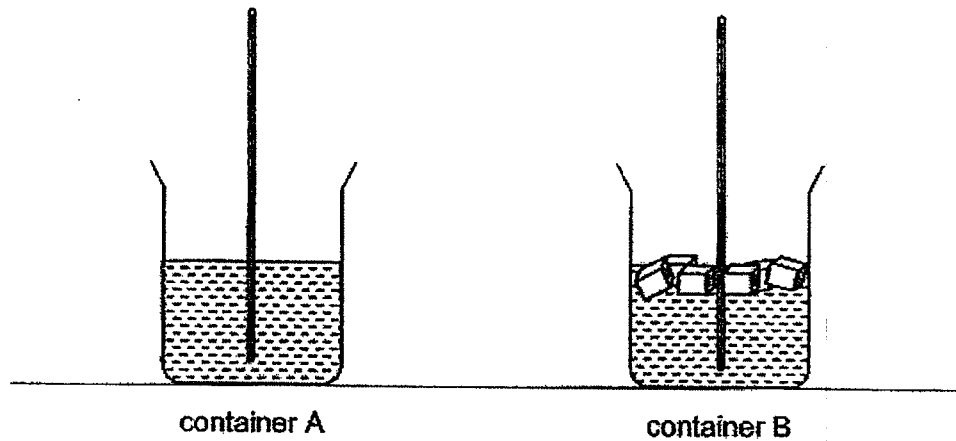

Which of the following graphs shows her results?

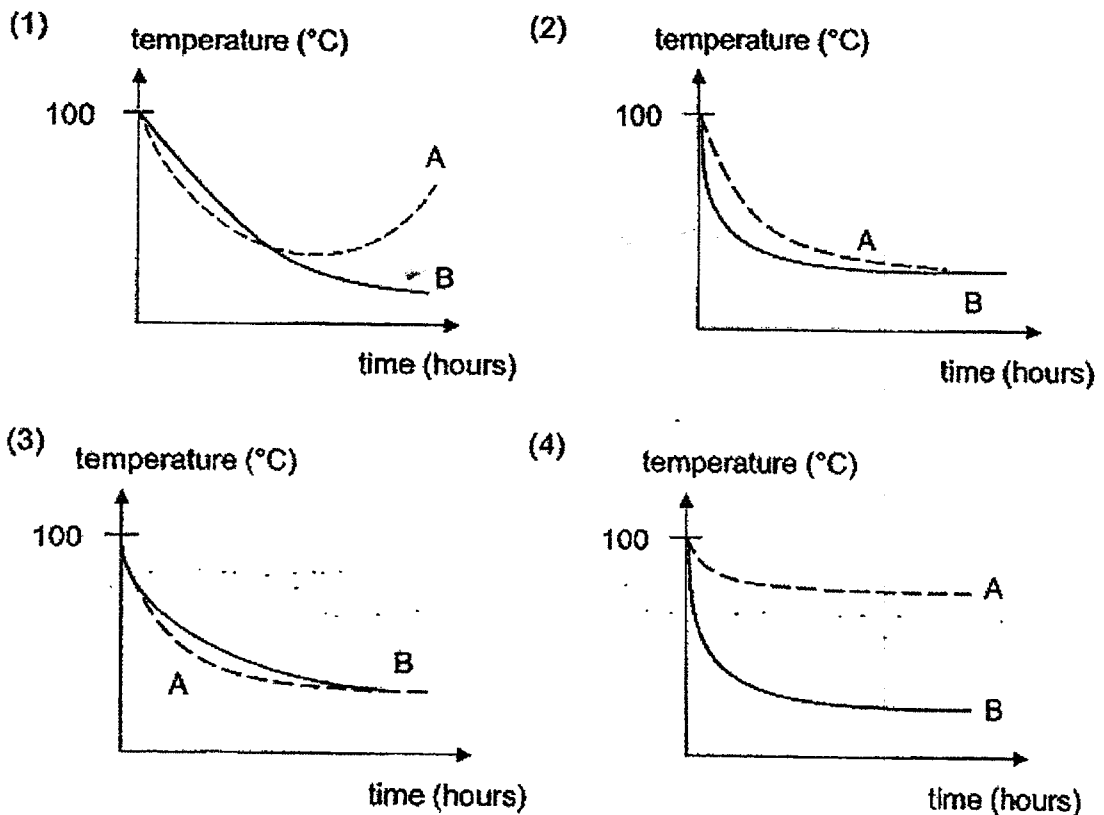

22. Aerith wanted to find out if the arrangement of bulbs in a circuit would affect their brightness. She set up circuits A, B, C, D and E below using identical parts.

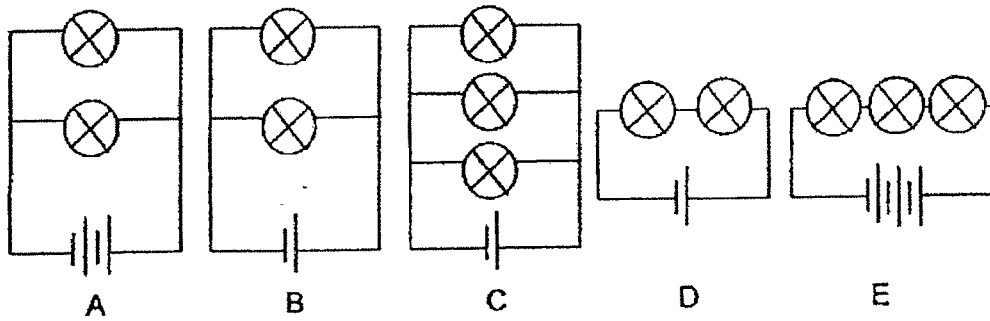

Which of the following circuits should she use to ensure a fair test?

- (1) A and B
- (2) A and D
- (3) B and D
- (4) C and E

23. Four objects, A, B, C and D, were arranged in an electric circuit as shown in the diagram below. Two of these objects were electrical conductors and the other two were electrical insulators.

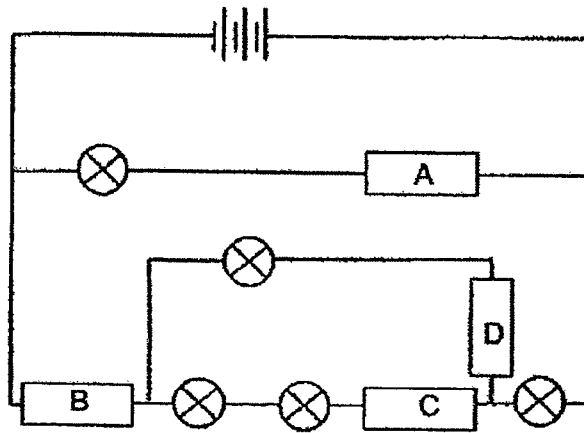

The arrangement only allowed two bulbs to light up.

Which of the following shows the correct property of the four objects, A, B, C and D?

	Electrical conductors	Electrical insulators
(1)	A and B	C and D
(2)	A and D	B and C
(3)	C and D	A and B
(4)	B and D	A and C

24. The diagram below shows air being pumped from a syringe into a container which has a volume of 80 cm^3 . The container has an original mass of 200 g .

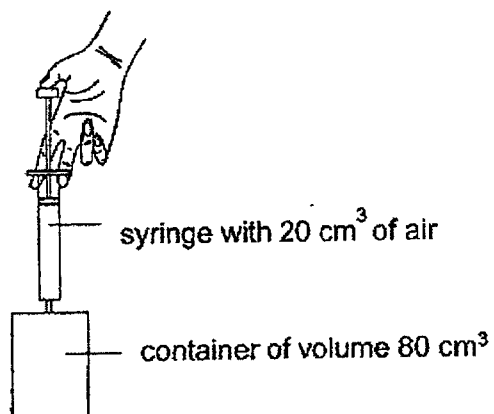

Which of the following shows the mass of the container and the volume of air in the container after all the air in the syringe is pumped into the container?

	mass of container (g)	volume of air in container (cm^3)
(1)	200	80
(2)	200	100
(3)	more than 200	80
(4)	more than 200	100

25. The set-up below shows light shining on three wooden frames, D, E and F, which are placed at different positions, X, Y and Z, from a torch.

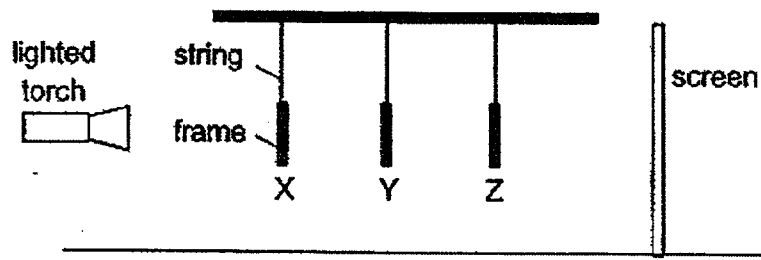

The experiment is conducted in a dark room. The diagrams below show the three frames D, E and F, and their shadows formed on the screen.

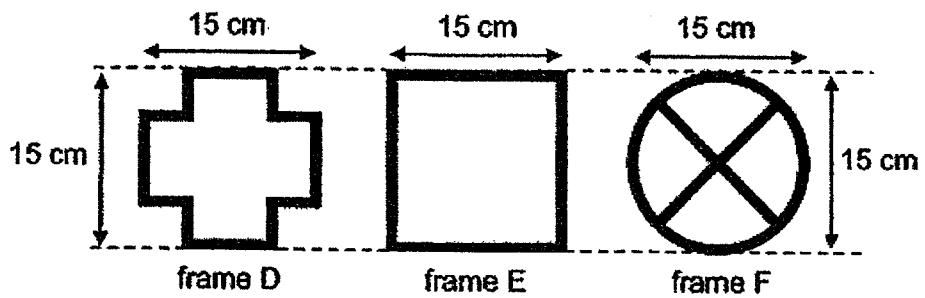

shadows of the frames cast on the screen

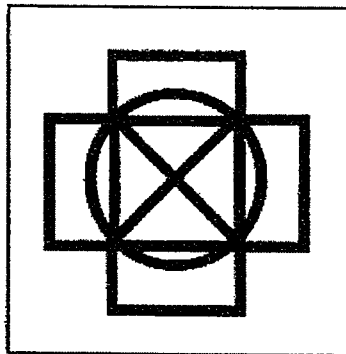

Based on the shadows cast on the screen, which of the following shows correctly the frames at positions X, Y and Z?

	Position X	Position Y	Position Z
(1)	D	E	F
(2)	E	F	D
(3)	F	D	E
(4)	D	F	E

26. Four objects E, F, G and H are arranged as shown in the diagram below. The arrows show the direction in which heat travels between the objects.



Which of the following statements about the temperature of the objects is / are correct?

- A. G is the coldest object.
 - B. E is colder than F and G.
 - C. G and H have the same temperature.
 - D. F is hotter than G but colder than E.
- (1) B only
(2) A and D only
(3) B and C only
(4) A, C and D only

27. Two uncooked eggs were placed in identical containers, as shown in the diagram below. Different amounts of water at 90°C were then poured into the containers. The eggs were left in the containers for 10 minutes.

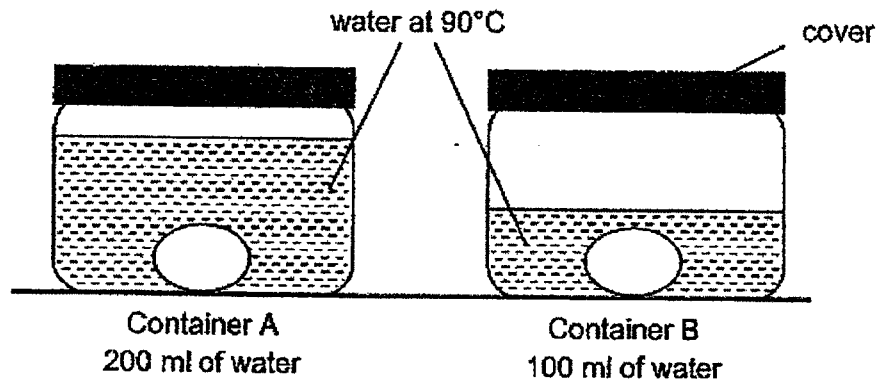

Which of the following is correct at the end of ten minutes?

	Observation	Explanation
(1)	Both eggs were equally cooked.	The water in both set-ups had the same amount of heat to cook the eggs.
(2)	Both eggs were equally cooked.	The water in both set-ups had the same temperature to cook the eggs.
(3)	The egg in Container A was less cooked than the egg in Container B.	The temperature in Container A was spread throughout more water so there was less heat in it.
(4)	The egg in Container B was less cooked than the egg in Container A.	The water in Container B had less heat than the water in Container A to cook the egg.

28. The flowchart shown below is used to classify some materials.

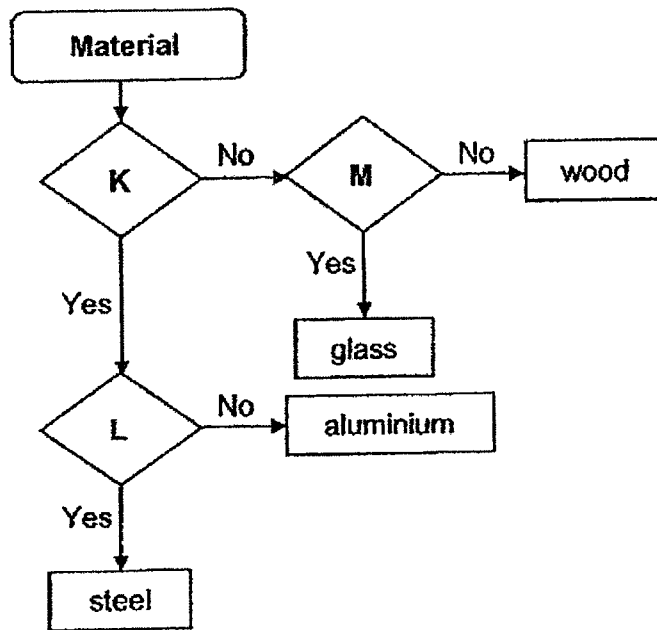

What are questions K, L and M?

	K	L	M
(1)	Is it magnetic?	Is it strong?	Is it waterproof?
(2)	Is it an electrical conductor?	Is it magnetic?	Does it allow light to pass through?
(3)	Is it magnetic?	Is it an electrical conductor?	Does it allow light to pass through?
(4)	Is it an electrical insulator?	Is it strong?	Is it waterproof?

END OF BOOKLET A

GO ON TO BOOKLET B



MAHA BODHI SCHOOL
2022 SEMESTRAL ASSESSMENT 2
PRIMARY FIVE SCIENCE
(BOOKLET B)

Name: _____ ()

Class: Primary 5 _____

Date : 31 Oct 2022

Total Duration for Booklets A and B: 1 h 45 min

INSTRUCTIONS TO CANDIDATES:

1. Do not turn over this page until you are told to do so.
2. Follow all instructions carefully.
3. Answer all questions.
4. Write all your answer in this booklet.

Booklet	Marks Obtained	Max Marks
A		56
B		44
Total		100

Parent's signature: _____

This booklet consists of 16 printed pages.

BLANK PAGE

BOOKLET B : [44 marks]

For questions 29 to 40, write your answers in this booklet.

The number of marks available is shown in the brackets [] at the end of each question or part-question.

29. Food samples are taken from parts A, B, C, D and E of the human digestive system.

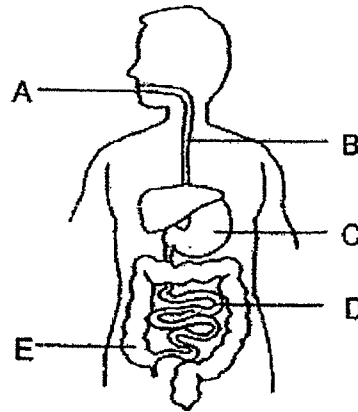

- (a) Based on the diagram above, which of the part(s) A, B, C, D or E produce(s) digestive juices? [1]

- (b) The amount of digested and undigested food at the end of parts A, B, C, D and E is shown in the graph below.

Draw in the graph below to show the amount of digested and undigested food at the end of part C. [1]

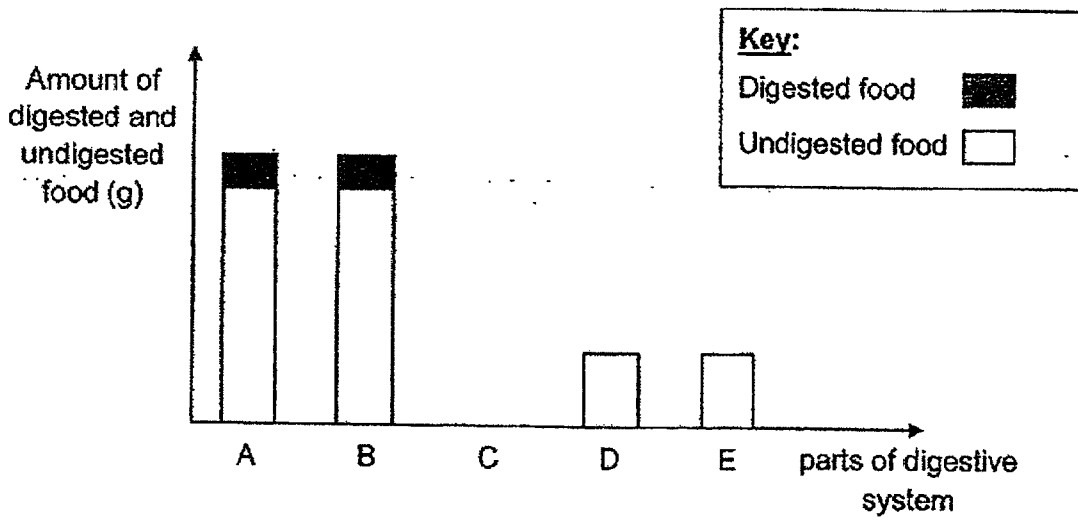

Marks : 12

- (c) The amount of food at the end of part D is the same as part E. Give one reason why this is so. [1]

- (d) Explain how the digestive system and the circulatory system work together to allow digested food to reach the rest of the body. [1]

Marks :

12

30. Sam removed an outer ring from the stem of a plant as shown below. The food-carrying tubes were removed while the water-carrying tubes remained in the stem.

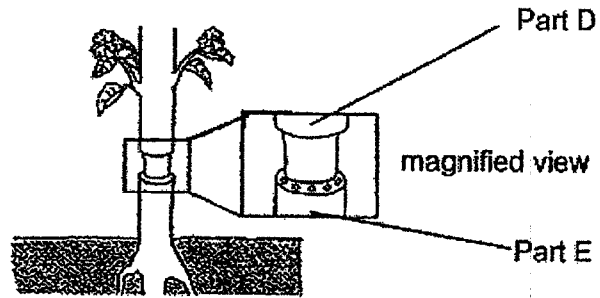

After some time, he measured and recorded the thickness of the stem at parts D and E in the table below.

Part	Thickness of stem (cm)		
	Day 1	Day 4	Day 7
D	16	18	20
E	16	16	16

- (a) Explain the change in thickness of part D. [2]

- (b) Sam observed that the plant with outer ring of the stem removed produced larger fruits compared to other plants.



Explain Sam's observation. [2]

Marks : / 4

31. Four similar balsam fruits, A, B, C and D were placed under different temperature conditions to find out the effect of temperature on the splitting of the balsam fruits. The results were then recorded in the table as shown below.

	Balsam fruit			
	A	B	C	D
Surrounding temperature (°C)	15	20	25	35
Time taken for fruit to split (hours)	did not split	after 24 hours	after 15 hours	after 3 hours
Distance of seeds scattered from the parent plant (m)	0	2	3	5

- (a) Which fruit, A, B, C or D split with the greatest force? Give a reason for your answer. [1]

- (b) From the above results, explain the relationship between the surrounding temperature and the time taken for the fruit to split. [1]

Marks :

12

32. Roy carried out an experiment to find out how the number of seeds in a pot of soil would affect the height of the seedlings. He filled three identical pots A, B and C with equal amount of soil. He then placed different number of seeds into each pot. The pots were placed at the same location and given an equal amount of water daily. The diagram below shows the height of seedlings after a week.

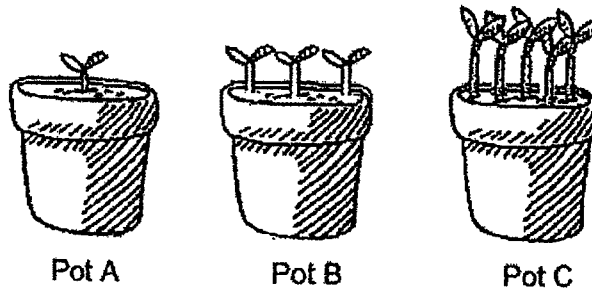

- (a) State all the condition(s) needed for germination to take place. [1]

- (b) Explain why the seedlings in Pot C are taller and thinner than those in Pot A. [2]

- (c) Give a reason how placing all three pots at the same location and giving the seedlings the same amount of water would ensure that the experiment was a fair test. [1]

Marks : / 4

33. John washed two shirts of the same material, shape and size and hung them on a clothesline under the sun to dry as shown below. Shirt X was left unfolded while shirt Y was folded into half.

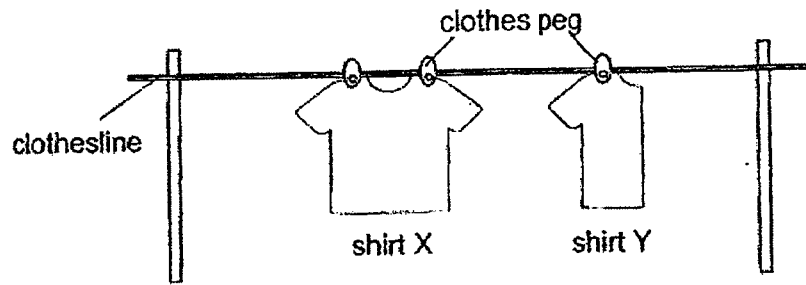

He recorded the mass of shirts X and Y in the table below.

Time (min)	Mass of shirt X (g)	Mass of shirt Y (g)
0	800	800
30	650	700
60	320	450
90	300	380
120	300	350

- (a) What is the mass of the shirt when it is dried? [1]

- (b) Based on the results, explain why shirt X dried faster. [2]

- (c) John wants to find out what is the relationship between the amount of heat and the time taken for the shirts to dry. What should he do to Shirt X to make the experiment a fair test? [1]

Marks :

14

34. Betty had two identical containers, A and B. She filled one container with hot water and the other container with cold water. She covered both containers to make sure no water could escape and placed them on a pan balance.

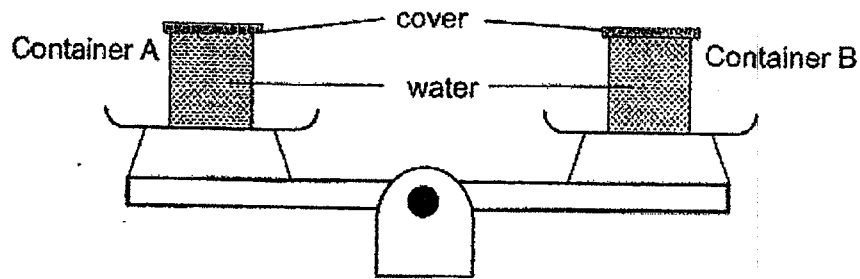

After a while, she observed that water droplets were formed on the outside of the container B and the pan balance tilted down towards it.

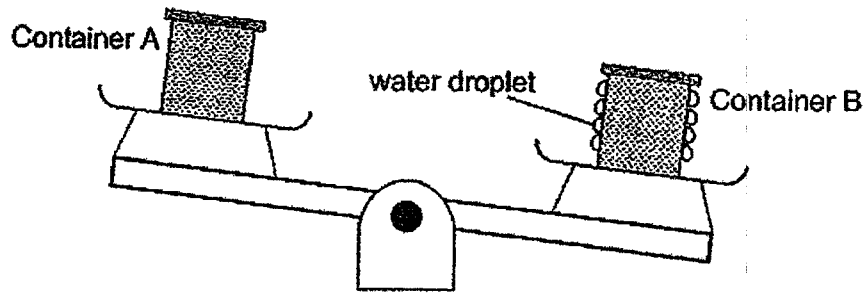

- (a) Which container contained hot or cold water? [1]
- (i) Container A: _____
- (ii) Container B: _____
- (b) Explain why water droplets were formed on the outside of container B. [1]

- (c) When Betty removed the covers from both containers, she observed that the pan balance tilted down even more towards container B after some time. There was no spillage of water from both containers. Explain her observation. [1]

Marks : / 3

35. Elaine carried out an experiment as shown in the diagram below.

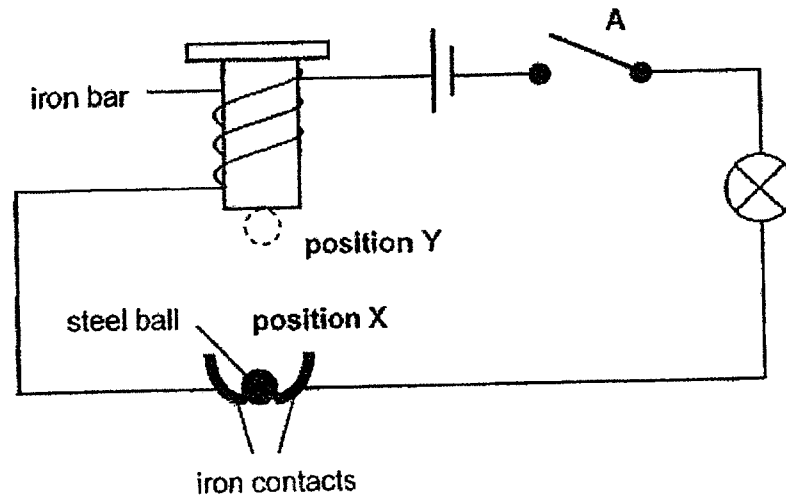

- (a) When she closed switch A and the steel ball was at position X, the light bulb lit up. Explain why the bulb lit up. [2]

- (b) When the bulb lit up, she also observed that the steel ball went up to position Y. After the steel ball went up to Y, the bulb did not light up. Explain her observation. [2]

- (c) She replaced the iron bar with another bar Q made of a different material. When she closed the switch, the steel ball did not move to position Y. Explain her observation. [1]

Marks :

15

36. Kelly placed a packet of tea into a mug as shown below.

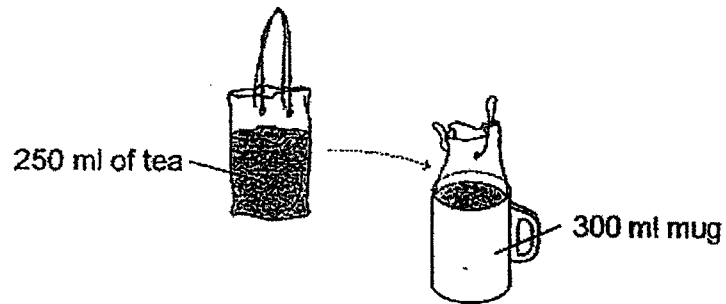

- (a) State a property of the tea that allowed Kelly to place it into the mug. [1]

- (b) Did the volume of the tea change after it was placed into the mug? Give a reason for your answer. [1]

- (c) Kelly wants to confirm the volume of the mug. Using a 500ml measuring cylinder and water, describe how she can confirm the volume of the mug. [2]

Marks :

/ 4

37. (a) Four sheets, C, D, E and F, made of different materials are arranged in a straight line in a dark room, as shown below. Sheet D has a metal piece pasted on it.

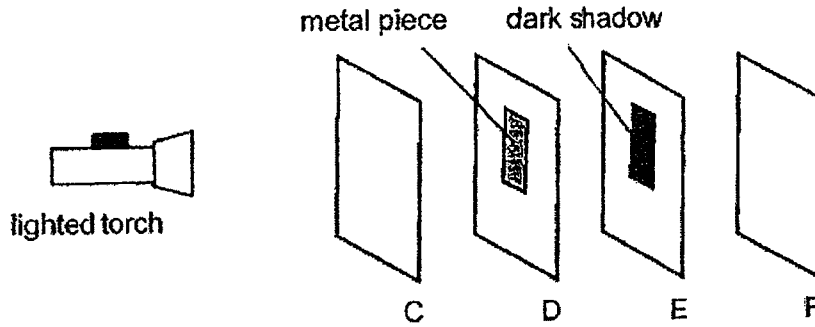

When the torch is switched on, a dark shadow is formed on sheet E.

Based on the observations stated, put a tick (✓) in the boxes to show if each of the following statements is true, false, or not possible to tell. [1]

	Statement	True	False	Not possible to tell
(i)	Sheets C and D allow light to pass through.			
(ii)	If the metal piece is pasted on sheet E instead of D, a dark shadow will be formed on Sheet F.			

Marks : / 1

- (b) A shopkeeper uses the set-up shown below to count the number of customers entering the shop.

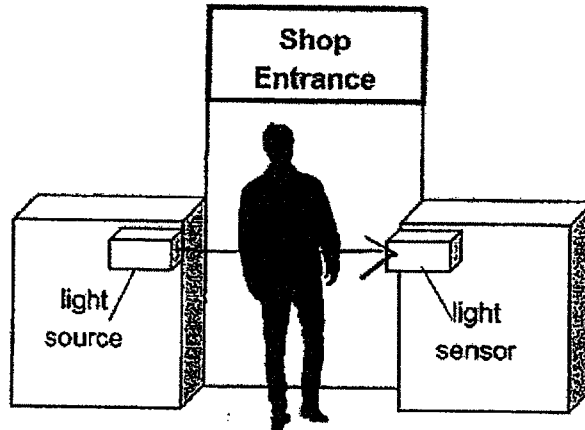

The data collected over a period of 10 minutes is shown in the graph below.

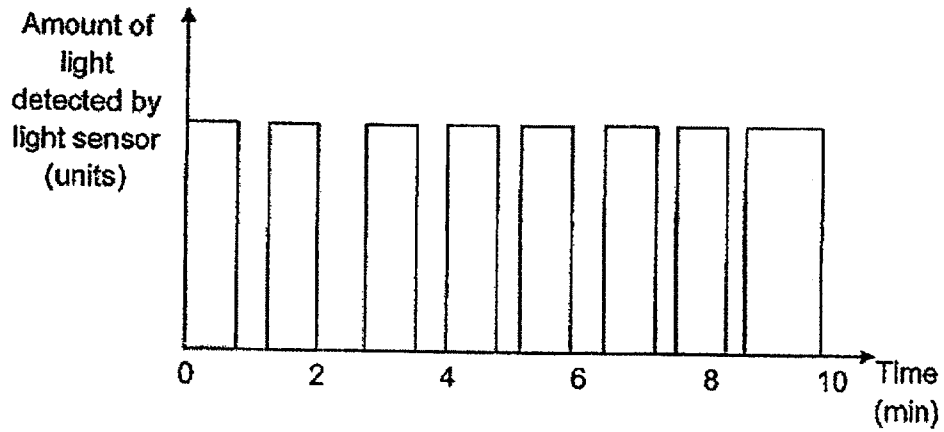

- (i) State one property of light which the above set-up demonstrates. [1]

- (ii) The set-up can only detect one person entering the shop at a time. Based on the graph, how many customers entered the shop during the 10 minutes? [1]

Marks :

/ 2

38. A group of students wanted to investigate how 'bubble wrap' would affect the amount of heat gained by cold water. "Bubble wrap" is a material that contains pockets of air.

The diagram below shows the set-up which the students prepared. The "bubble wrap" was rolled tightly around the beaker.

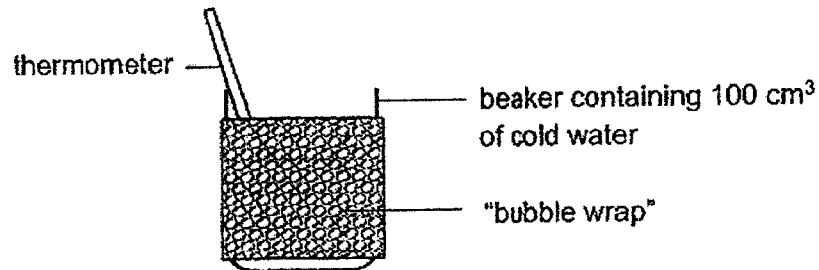

- (a) To carry out their investigation, the students needed to have a control set-up. State the difference between the control set-up and the set-up with "bubble wrap" as shown above. [1]

- (b) The students recorded the temperature readings of both set-ups over time. The results are shown in the graph below.

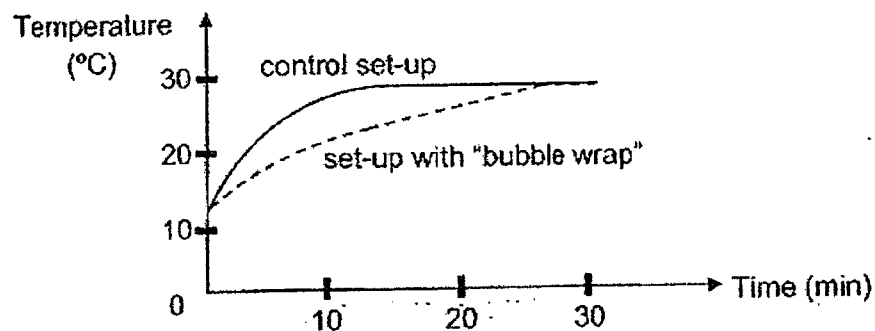

- Explain how the "bubble wrap" affected the amount of heat gained by the cold water. [2]

Marks : 13

- (c) The students replaced the water in both set-ups with 100 cm³ of water at 100°C.

Would the water in the control set-up be warmer or colder than the water in the set-up with "bubble wrap" after 30 minutes? Explain your answer. [1]

- (d) Houses in countries which experience both extremely cold and hot weathers during the year usually have insulation layers installed between the roof and the ceiling. The insulation layers contain air pockets.

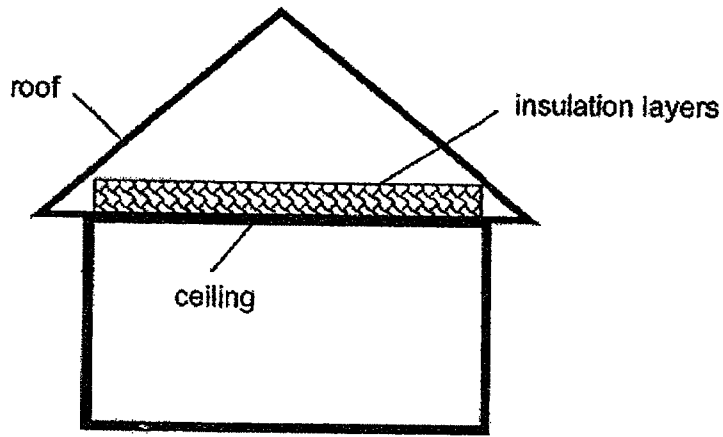

Explain how these insulation layers help the people living in the house during the extremely hot weather. [1]

Marks :

/ 2

39. A group of students set up an experiment, as shown in the diagram below, to compare a property of four strips of different materials, W, X, Y and Z.

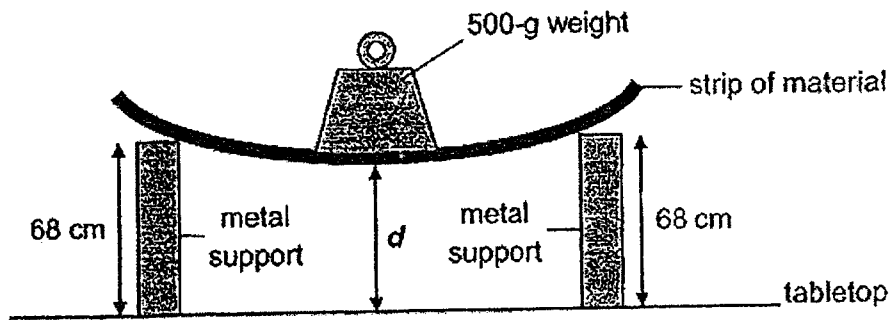

For each strip of material, they measured the distance 'd' when a 500-g weight was placed on the strip.

The results of the experiment are shown in the table below.

Material	d (cm)
W	60
X	48
Y	68
Z	54

- (a) Based on the results, what property of the materials were the students trying to find out? [1]

- (b) Name two other variables that must be kept constant to ensure a fair test. [1]

Marks :

12

- (c) The students wanted to choose a material to make a 'selfie' stick to hold a phone camera to take photographs.

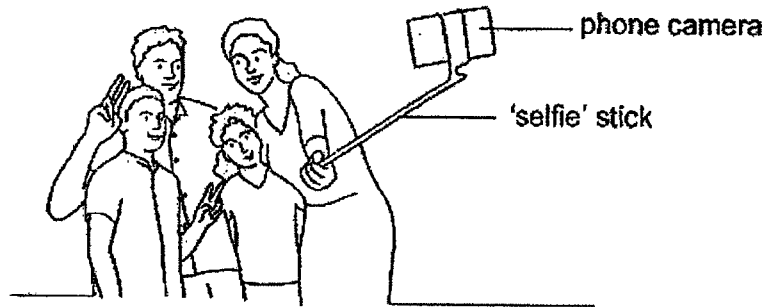

Based on the results of the experiment, which material, W, X, Y or Z, is most suitable for making the 'selfie' stick? Explain your answer. [2]

Marks :

12

40. Jen placed a bar magnet near a compass on a table as shown below.

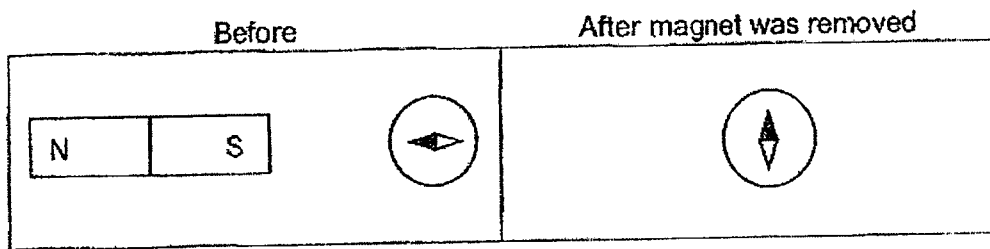

- (a) After Jen removed the magnet, she observed that the compass needle pointed in a different direction. Explain her observation. [1]

- (b) Identify the pole indicated by X on the compass. [1]

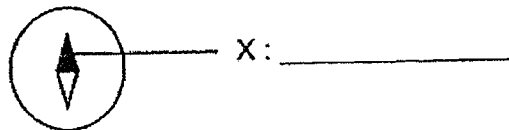

Marks :

/ 2

~ END OF PAPER ~

MAHA BODHI SCHOOL
2022 PRIMARY FIVE SEMESTRAL ASSESSMENT 2
SCIENCE

BOOKLET A: 56 marks

1. 2	6. 2	11. 2	16. 1	21. 2	26. 2
2. 1	7. 4	12. 3	17. 2	22. 3	27. 4
3. 3	8. 2	13. 2	18. 4	23. 4	28. 2
4. 2	9. 4	14. 2	19. 2	24. 3	
5. 2	10. 3	15. 4	20. 4	25. 4	

BOOKLET B: 44 marks

Qn		Answers (Full marks)
29	a	Parts A, C and D
	b	<div style="display: flex; align-items: flex-start;"> <div style="margin-right: 20px;"> <p>Amount of digested and undigested food (g)</p> </div> <div style="text-align: center;"> </div> <div style="margin-left: 20px;"> <p>Note:</p> <ul style="list-style-type: none"> • The total amount of digested and undigested food is the same as that of A and B. • The amount of digested food is more than that of A and B. • The amount of undigested food is less than that of A and B but greater than that of D and E. </div> </div>
	c	<ul style="list-style-type: none"> • The large intestine only absorbs water Or • The large intestine does not absorb (undigested) food.
	d	<p>Digested food enters the blood through the small intestine.</p> <p>The blood transports the digested food to all parts of the body.</p>

Qn		Answers (Full marks)
30	a	Part D will increase in size as food made by the leaves cannot be transported to the roots or part E. So the food is stored at D.
	b	Food made by the leaves cannot be transported to the parts below D or to the roots. More/Excess food transported and stored in the fruits
31	a	D, the seeds are scattered <u>furthest</u> from the parent plant.
	b	The higher the surrounding temperature, the faster the time taken for the fruit to split as the pod will dry up faster .
32	a	Air/Oxygen, Warmth/Suitable temperature, Water
	b	<u>Cause:</u> Seedlings in pot C has less space to grow/are overcrowded but Seedlings in A has enough space to grow. (show comparison between A and C) AND <u>Effect:</u> As a result, seedlings in C grew taller to <u>receive more sunlight</u> .
	c	This ensures that the difference in height of the seedlings is only due to the different number of seeds in each pot. Or This ensures that the amount of water or the location will not affect the change in height of the seedlings.
33	a	300g
	b	Shirt X has a larger exposed surface area . Water in shirt X evaporated faster (into water vapour).
	c	Fold shirt X into half. Place the shirts separately in locations with different temperature .
34	a	(i) Container A: Hot water (ii) Container B: Cold water
	b	Water vapour from the surrounding lost heat and condense to form water droplets.
	c	The water in container A evaporated faster than container B as the temperature of the water in A is higher.

Qn		Answers (Full marks)															
35	a	The steel ball is an <u>electrical conductor</u> . At position A, the steel ball formed a <u>closed circuit</u> causing the bulb to light up.															
	b	The iron bar became <u>an electromagnet</u> and attracted the steel ball This caused the <u>circuit to become open</u> .															
	c	Bar Q is made of <u>non-magnetic material</u> . So it will not be an <u>electromagnet</u> to attract the steel ball.															
36	a	Tea has no definite shape															
	b	No. Tea / liquids have definite volume.															
	c	Fill the mug to the brim with water and transfer the water to the measuring cylinder. Measure the volume of water in the measuring cylinder. OR Measure 300 ml of water using the measuring cylinder and pour it into the mug. If the water did not overflow the mug is 300 ml															
37	a	<table border="1"> <thead> <tr> <th></th> <th>Statement</th> <th>True</th> <th>False</th> <th>Not possible to tell</th> </tr> </thead> <tbody> <tr> <td>(i)</td> <td>Sheets C and D allow light to pass through.</td> <td>✓</td> <td></td> <td></td> </tr> <tr> <td>(ii)</td> <td>If the metal piece is pasted on sheet E instead of D, a dark shadow will be formed on Sheet F.</td> <td>✓</td> <td>✓</td> <td>✓</td> </tr> </tbody> </table>		Statement	True	False	Not possible to tell	(i)	Sheets C and D allow light to pass through.	✓			(ii)	If the metal piece is pasted on sheet E instead of D, a dark shadow will be formed on Sheet F.	✓	✓	✓
	Statement	True	False	Not possible to tell													
(i)	Sheets C and D allow light to pass through.	✓															
(ii)	If the metal piece is pasted on sheet E instead of D, a dark shadow will be formed on Sheet F.	✓	✓	✓													
	b	(i) Light travels in a straight line. OR Light can be blocked by an object.															
		(ii) 7 people															
38	a	The control set-up did not have the 'bubble wrap' but the other set-up had.															
	b	(i) The air in the bubble wrap is a <u>poor conductor of heat</u> and <u>slowed down / reduced the gain of heat</u> by the cold water from the <u>surroundings</u> .															

Qn		Answers (Full marks)
	(c)	The water in control set-up would be colder . The water lost heat faster to the surrounding .
	(d)	The insulation layers slow down the heat gain in the house from the (hot) surroundings . So it is cooler in the house than outside the house.
39	a	Flexibility OR The ability of the materials to bend without breaking.
	b	[Any two of the following] <ul style="list-style-type: none"> • Distance between the two (metal) supports. • Thickness / length of the strips. (same point) • Position where the 500-g weight was placed. • The number of weights
	c	[Claim] Material Y. [Evidence] When the 500-g weight was placed on it, it did not bend / d is the highest. [Reasoning] The material is stiffest and can hold the phone camera up so that it does not wobble or shake to take photographs.
40	a	When the magnet is removed, the compass needle will come to rest in the north-south direction . [1]
	b	North .