

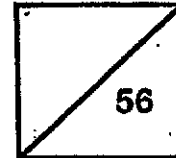

Rosyth School
End-of-Year Examination 2020
SCIENCE
Primary 5

Name: _____

Total
Marks:



Class: Pr 5 _____

Register No. _____

Date: 3 November 2020

Total Time for Booklets A and B: 1 h 45 min

Parent's Signature: _____

Booklet A

Instructions to Pupils:

1. Do not open the booklets until you are told to do so.
2. Follow all instructions carefully.
3. This paper consists of 2 booklets, Booklet A and Booklet B.
4. For questions 1 to 28 in Booklet A, shade your answers on the Optical Answer Sheet (OAS) provided using a 2B pencil.

*** This booklet consists of 19 printed pages (including cover page).**

For each question from 1 to 28, four options are given. One of them is the correct answer. Make your choice (1, 2, 3 or 4). Shade the correct oval (1, 2, 3 or 4) on the Optical Answer Sheet. **(56 Marks)**

1 The diagram below shows a cell.

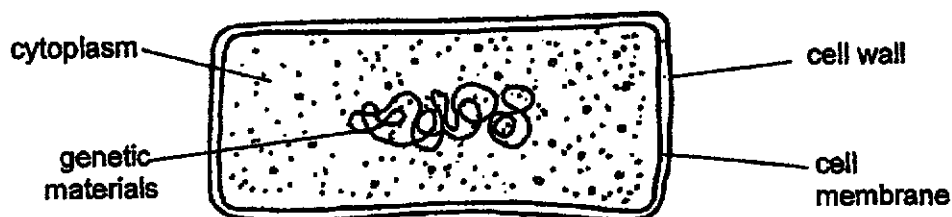

How is this cell different from a root cell?

- (1) It has cytoplasm.
- (2) It has no nucleus.
- (3) It has no chloroplasts.
- (4) It has a cell membrane.

2 The graph below shows the changes in the height of Mr Tan from birth to 80 years old.

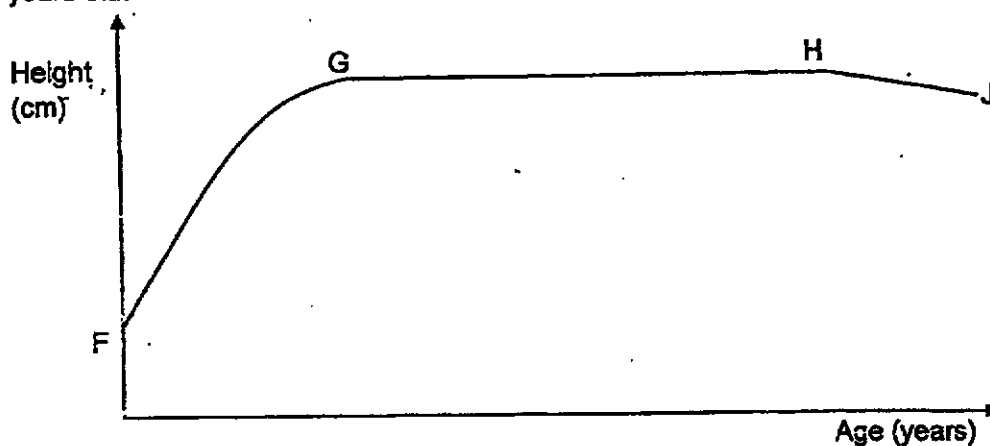

Which of the following statement(s) is/are correct?

- A From G to H, the cells in the body stop dividing.
- B From H to J, the cells in the body shrink in size.
- C From F to G, the cells in the body increase in number.
- D Cell division takes place throughout the period from F to J.

- (1) A only
- (2) C only
- (3) B and D only
- (4) C and D only

- 3 Diana wanted to find out if cells divide at a faster rate when an electric current is passed through it. She filled each dish with some substances as shown below.

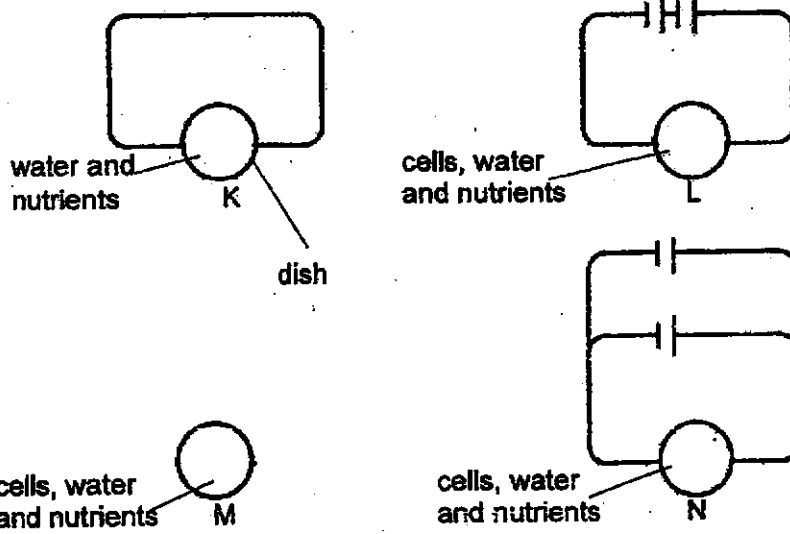

Which two set-ups should she use?

- (1) K and L
- (2) K and N
- (3) L and M
- (4) L and N

- 4 The diagram below shows the water and food-carrying tubes in a plant's cross-section of a stem and root.

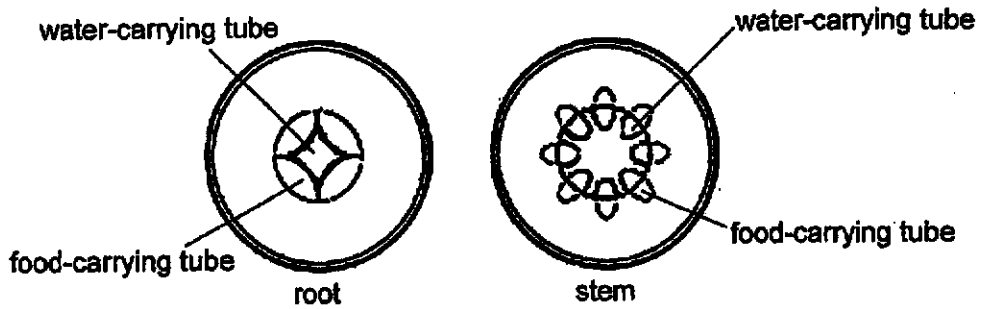

The plant was placed in water containing black dye. After 24 hours, the plant was removed and a section was taken from the root and stem.

Which diagram shows the result?

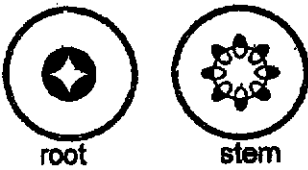
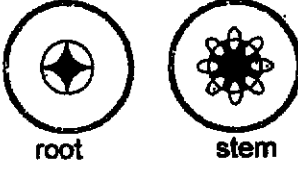
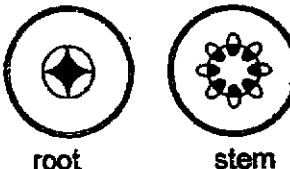
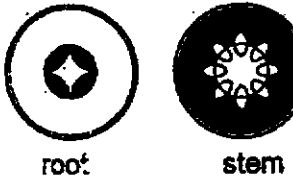
- (1)  (2)  (3)  (4) 

- 5 The diagram below shows part of the trunk of a tree with a ring of bark removed. Removing the ring of bark takes away the food-carrying tubes but leaves the water-carrying tubes untouched.



What will be the effect on the two branches?

	upper branch		lower branch	
	growth	leaves	growth	leaves
(1)	normal	normal	normal	normal
(2)	swollen	wilted	normal	normal
(3)	reduced	wilted	reduced	wilted
(4)	normal	normal	normal	wilted

- 6 The diagram below show the movement of water through a plant from the roots to the leaves.

Which arrow(s) show movement of water in the liquid state?

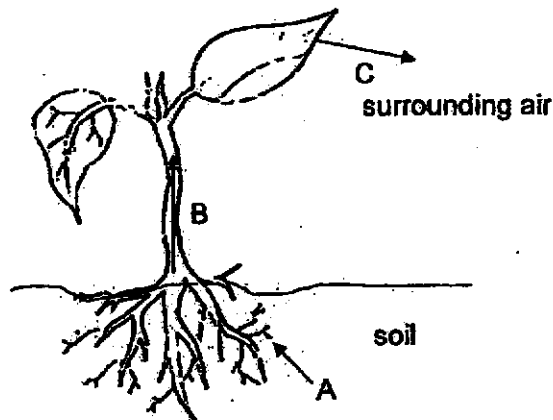

- (1) A only
 (2) A and B only
 (3) A and C only
 (4) A, B and C

7 Which one of the following statements about the respiratory system of a fish is not correct?

- (1) The gill cover protects the gills.
- (2) Oxygen is absorbed into the bloodstream.
- (3) Gaseous exchange takes place in the gills.
- (4) Water rich in carbon dioxide passes out through the mouth.

8 An experiment is set up as shown. Flask A and B contain limewater. Air is pumped through the flasks.

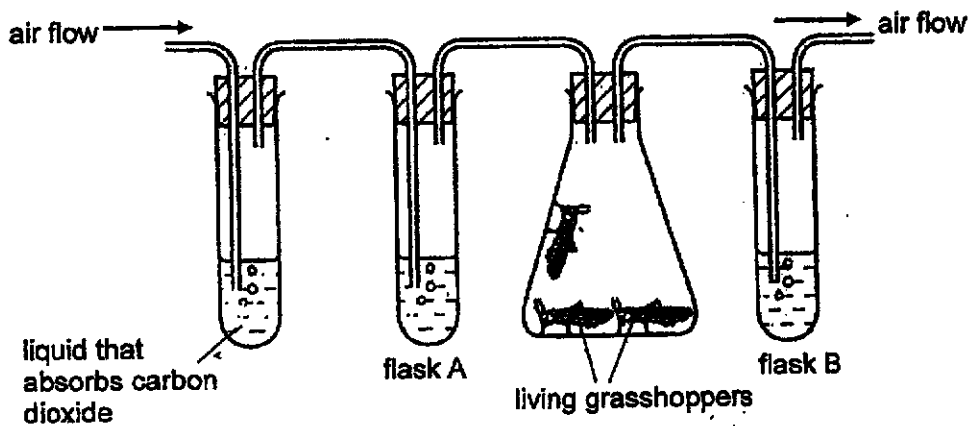

What is the appearance of limewater in flask A and B after a period of twenty minutes?

	flask A	flask B
(1)	chalky	chalky
(2)	clear	chalky
(3)	chalky	clear
(4)	clear	clear

- 9 Peter started doing vigorous exercises for several minutes and then stopped to rest. He noted the effect on his heart rate from the start.

Which one of the graphs shows that Peter stopped exercising at point K?

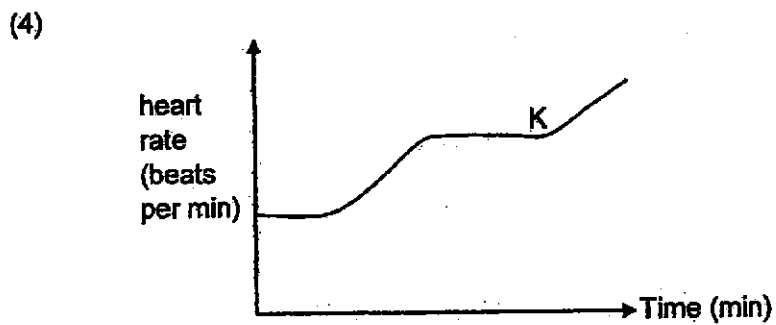
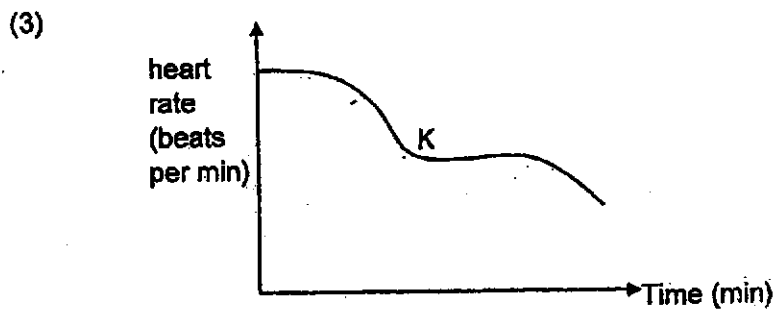
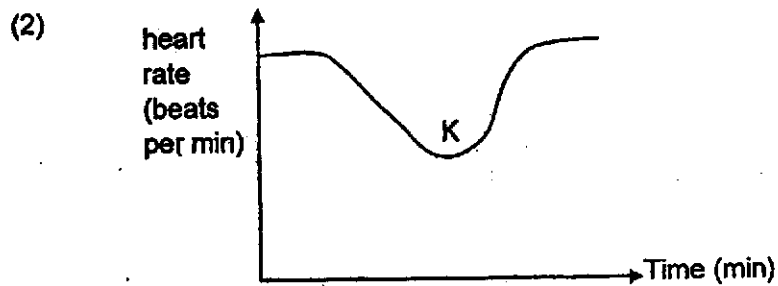
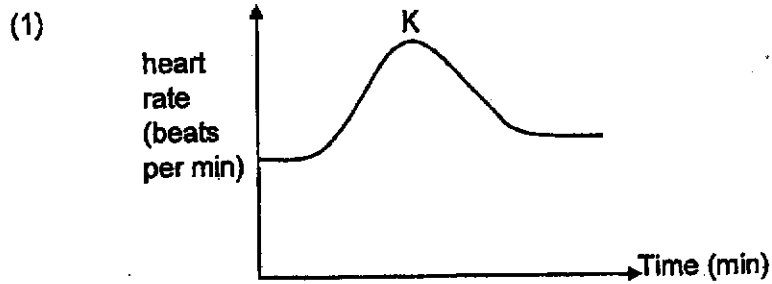

- 10 The diagram below shows the finger-like structures found on the inner wall of the small intestine. The part is supplied by blood vessels for the blood to flow in and out of the part.

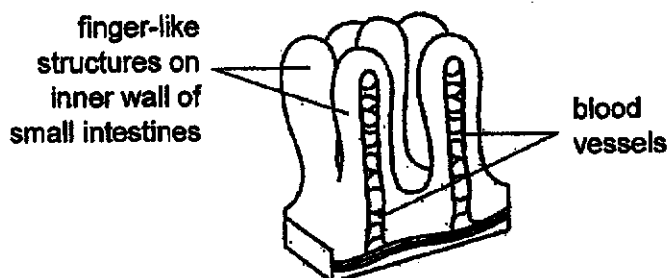

The amount of oxygen, carbon dioxide and digested food in the blood flowing in to the part was compared with that of the blood flowing out about two hours after a meal.

Which one of the following the correct comparison?

Blood flowing in to the finger-like structure has _____ than blood flowing out.			
(1)	more oxygen	less carbon dioxide	less digested food
(2)	less oxygen	more carbon dioxide	more digested food
(3)	more oxygen	less carbon dioxide	more digested food
(4)	less oxygen	more carbon dioxide	less digested food

- 11 The diagram shows a fruit attached to a parachute of hairs.

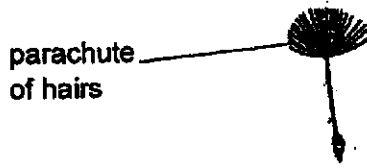

The table below shows the results of an experiment to investigate the time taken for four fruits of the same plant to fall to the ground.

Fruit	Size of parachute of hairs (cm)	Time taken to fall to the ground (s)
P	1.3	4.5
Q	1.0	4.0
R	0.7	2.5
S	0.5	1.6

Which conclusion can be drawn from these results?

- (1) Fruit dispersed by wind must have presence of hair.
 - (2) Parachute size affects the time taken for the fruit to fall to the ground.
 - (3) Fruit P remained afloat in the air least while Fruit S remained in the air the most.
 - (4) As the parachute size increases, the time taken to fall to the ground decreases.
- 12 The diagram below shows a flower. Joe removed the structures labelled X before they had developed fully.

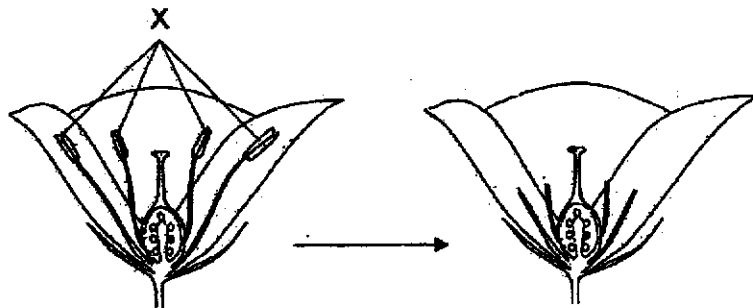

What is the effect of removing these structures?

- (1) It prevents the flower from being fertilised.
- (2) It prevents the flower from being pollinated.
- (3) It prevents the flower from pollinating itself.
- (4) It prevents the flower from producing seeds.

13 In which test-tube would the bean seeds germinate most quickly?

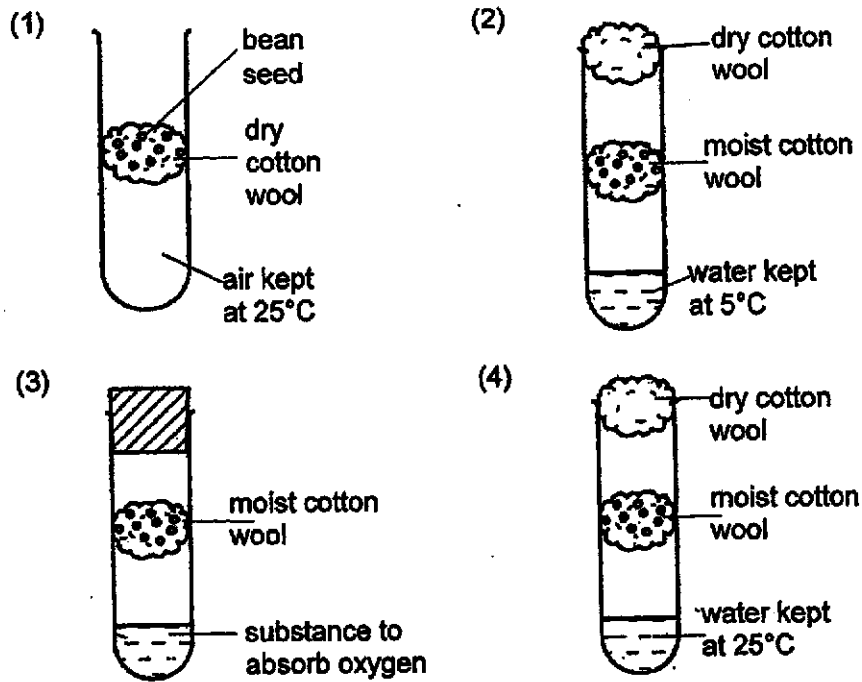

14 Study the classification chart.

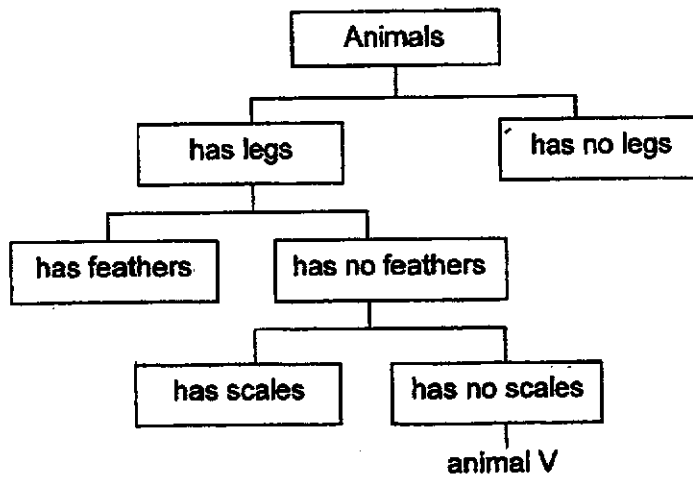

Which group of animal does animal V belong to?

- (1) fish
- (2) birds
- (3) reptiles
- (4) amphibians

15 The diagrams below show four different circuit connections.

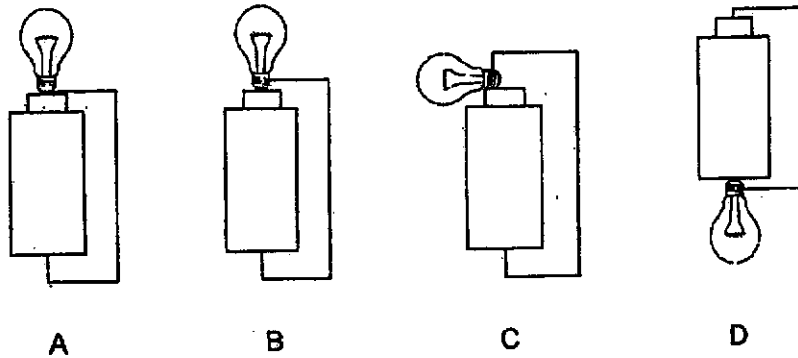

Which two connections will the bulb light up?

- (1) A and B
- (2) A and D
- (3) B and C
- (4) B and D

16 Study the circuits below.

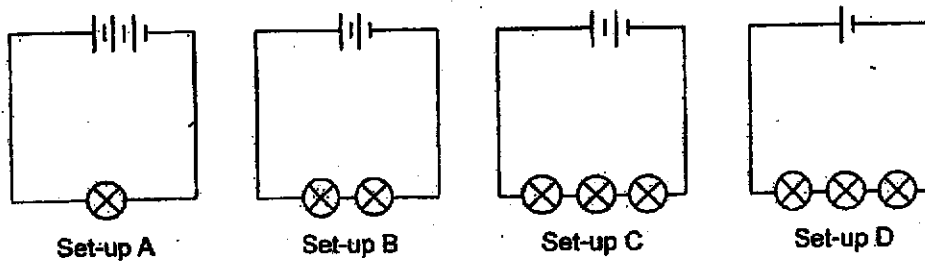

Which of the following is correct?

	Least Bright	Brightest
(1)	C	A
(2)	D	A
(3)	D	B
(4)	C	B

- 17 Three children set up an electric circuit as shown in the diagram below and each made a statement about the circuit.

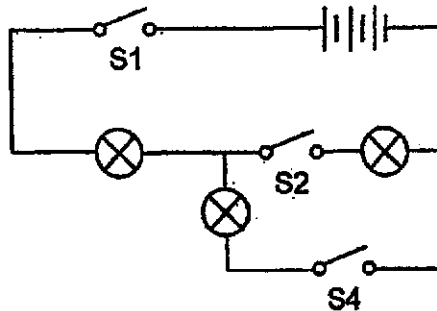

Closing switches S1 and S2 can light up two bulbs.



Nirmal



Anne



Junming

Closing switches S1 and S4 can light up two bulbs.

Closing all the switches will light up two bulbs.

Whose statement(s) is/are correct?

- (1) Nirmal only
- (2) Junming only
- (3) Nirmal and Anne
- (4) Nirmal and Junming

- 18 A plastic bag sealer makes one part of the plastic bag melt and sticks together with the opposite side, creating a sealed line across as the plastic cools and solidifies. An experiment was conducted with different number of batteries in a circuit and different thicknesses of heating element being connected across point X and Y. The length of the heating element was the same.

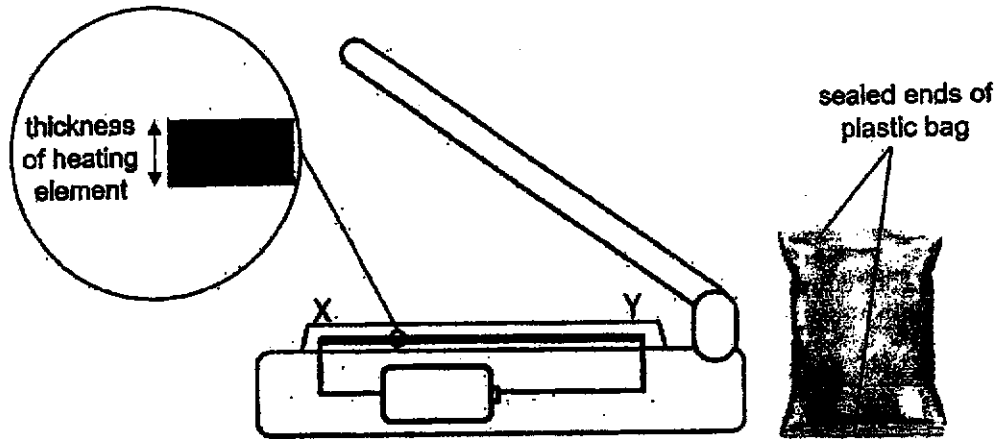

The results of the experiment was recorded below.

Number of battery	Thickness of heating element (mm)	Temperature of heating element after 1 minute (°C)
1	0.5	55
1	1.0	50
1	1.5	40
2	0.5	70
2	1.0	60
2	1.5	45

Based on the results, which is the best way to heat up the heating element to seal a thick plastic bag?

	Amount of current	Thickness of heating element
(1)	High	Thin
(2)	High	Thick
(3)	Low	Thin
(4)	Low	Thick

19 Three different processes were observed.









- A a cup of tea boiling
- B a block of butter melting
- C a drop of liquid wax hardening

Which of the following process(es) will involve heat loss by the object?

- (1) A only
- (2) B only
- (3) C only
- (4) B and C only

20 Study the weather report of four days.

Which day is most suitable to hang washed clothes outside in the morning to dry by the end of afternoon?

	Day	Morning	Afternoon
(1)	Sunday	 Sunny	 Rainy
(2)	Monday	 Thunderstorm with strong wind	 Sunny
(3)	Tuesday	 Strong wind	 Cloudy
(4)	Wednesday	 Very sunny	 Rainy

21 Which of the following statements about the water cycle is true?

- (1) Heat is lost by the water that evaporates.
- (2) Rain falls when the temperature in the sky lowers.
- (3) Heat is gained by water vapour that becomes clouds.
- (4) Heat is gained by the surrounding air when clouds form.

22 Ainu conducted an experiment by heating substance P. At the start, P was a solid at 30°C. After 10 minutes of heating, P reached a temperature of 90°C as shown.

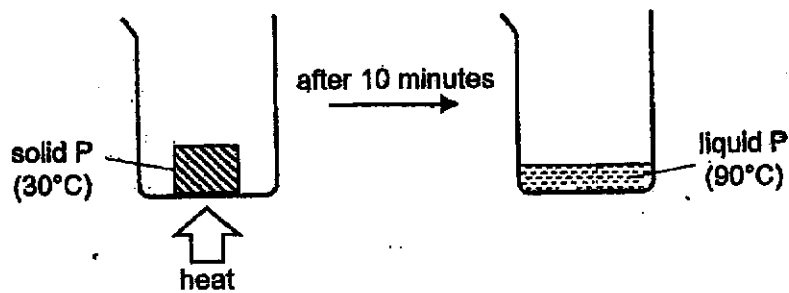

Based on Ainu's experiment, which one of the following is possible?

	Melting point of P (°C)	Boiling point of P (°C)
(1)	30	105
(2)	50	80
(3)	30	80
(4)	50	105

- 23 A, B and C represent the three states of matter. Which two arrows indicate melting and evaporation respectively?

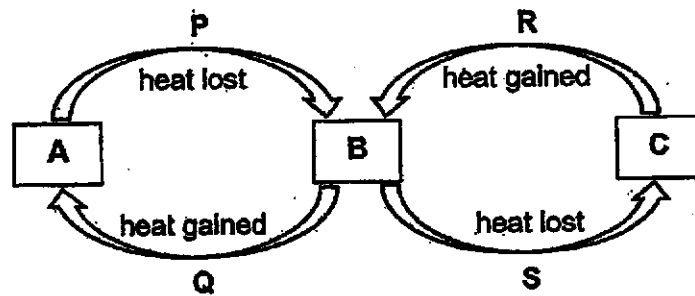

	Melting	Evaporation
(1)	R	Q
(2)	Q	P
(3)	P	S
(4)	S	R

- 24 Tim has a kettle of boiling water.



Tim made some statements.

- A There is no steam produced.
- B Condensation has taken place.
- C The temperature of the cloud is 100°C.
- D The mass of water in the kettle is decreasing.

Which statements are not correct?

- (1) A and B only
- (2) A and C only
- (3) B and C only
- (4) C and D only

- 25 Diana was driving and observed that the inner surface of her car's windscreen has lots of water droplets.

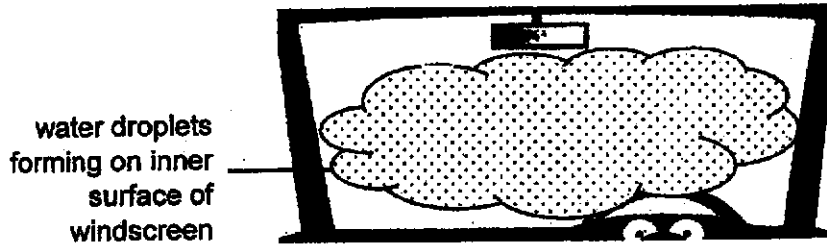

Which is the most possible temperature of air outside and inside the car that could form the most water droplets?

	Temperature outside the car (°C)	Temperature inside the car (°C)
(1)	16	17
(2)	28	16
(3)	16	29
(4)	29	29

- 26 The diagram below shows the water level in a measuring cylinder before and after a stone is dropped in.

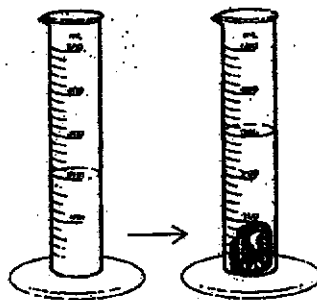

What is the purpose of this set-up?

- (1) To measure the mass of the stone
- (2) To measure the volume of the stone
- (3) To show that stone cannot be compressed
- (4) To show that water does not have a fixed shape

- 27 Three different types of powder are mixed together. The powders cannot dissolve in water. The following table shows the properties of the three powders.

	Property A	Property B	Property C	Property D
Powder	Does it sink in water?	Is it magnetic?	Does it allow light to pass through?	Does it conduct electricity?
X	Yes	Yes	No	No
Y	Yes	No	No	Yes
Z	No	Yes	No	No

If someone wants to separate the three types of powder most quickly, which two properties should he make use of?

- (1) A and B
- (2) A and C
- (3) B and D
- (4) C and D

28 An ice cube is placed on a spoon made of material P.

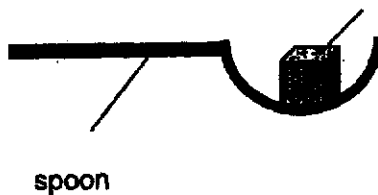

The time taken for the ice cube to completely melt when placed on the spoon was recorded below. The experiment is repeated for identical ice cubes and identical spoons made of material Q, R and S.

Material of spoon	Mass of spoon (grams)	Time taken for ice cube to melt completely (seconds)
P	32	56
Q	45	80
R	35	157
S	90	162

Which material is most suitable for making the food delivery box so that the rider can bear the weight of the box better over a long distance, yet able to keep food hot when delivered?



- (1) Material P
- (2) Material Q
- (3) Material R
- (4) Material S

(Go to Booklet B)



Rosyth School
End-of-Year Examination 2020
SCIENCE
Primary 5

Total
Marks:

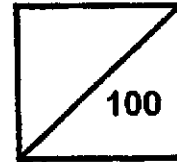

Name: _____

Class: Pr 5 _____

Register No. _____

Date: 3 November 2020

Total Time for Booklets A and B: 1 h 45 min

Parent's Signature: _____

Booklet B

Instructions to Pupils:

1. For questions 29 to 40, write your answers in the spaces given in this booklet.

	Maximum	Marks Obtained
Booklet A	56 marks	
Booklet B	44 marks	
Total	100 marks	

* This booklet consists of 13 printed pages (including cover page).

For questions 28 to 40, write your answers in the space provided. (44 Marks)

- 29 The diagram below shows a unicellular organism X often found growing on the bark of trees.

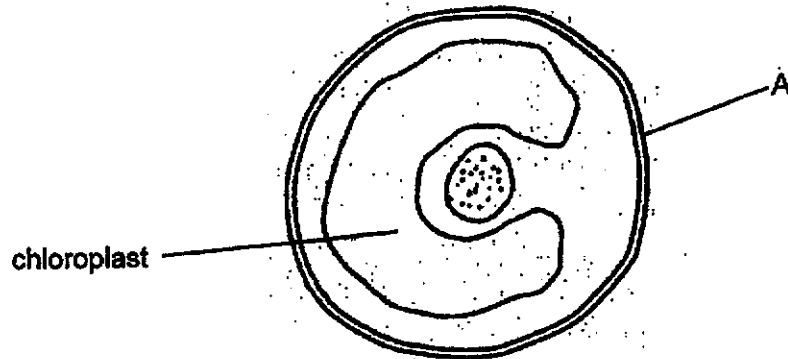

- (a) Identify the part of the cell labelled A. [1]

- (b) Name two parts of organism X that can be found in both plant and animal cells. [1]

- (c) How does organism X obtain food? Support your answer. [1]

The diagram below shows a leaf cell.

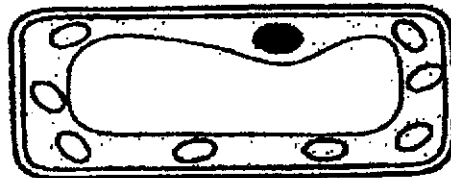

- (d) Observe organism X and the leaf cell. State a difference between them. (Do not mention shape and size) [1]

- 30 Jonny grew some celery plants in her garden. She saw some tiny insects feeding on the stem of her celery plant. These insects used their mouths to poke into the stem of the plant.

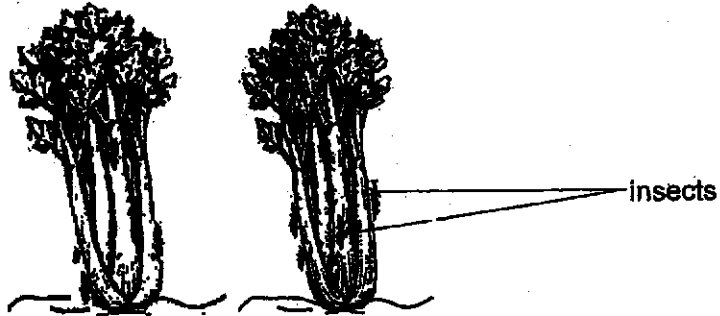

- (a) Explain why these insects poke into the stems. [1]

She sprays a lot of pesticide and the pesticide enters the soil and gets absorbed by the plant.

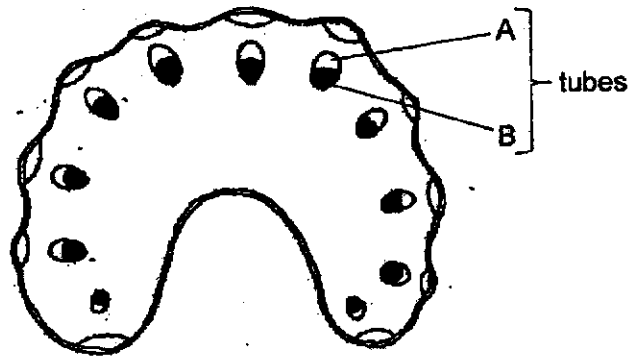

The diagram above shows the cross section of a celery stem. The shaded part of the tubes is where she could find pesticide.

- (b) Is part B a food-carrying tube or water-carrying tube? Explain why. [2]

31 The diagram below shows a plant.

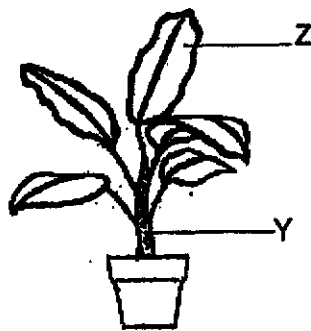

(a) Identify the substance that is transported from Z to the roots. [1]

(b) Besides transporting substances, state another function of Y. [1]

Jill conducted an investigation. She took two similar pots of plants A and B. She put a plastic bag around the pot of the potted plant A as shown below. She tied a string tightly around the plastic bag and the stem. She placed them at the same place and watered only the leaves of both plants.

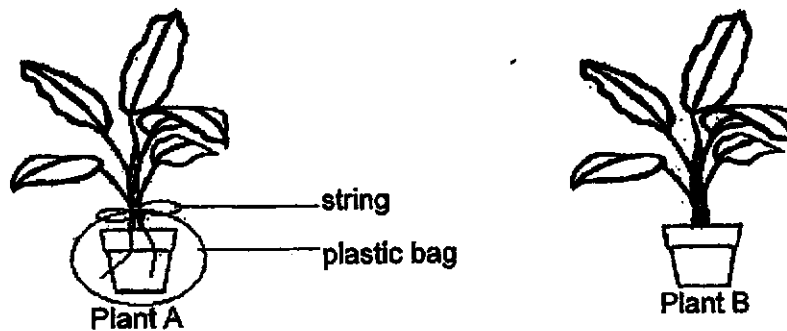

(c) Plant A died but Plant B did not. Explain why Plant B did not die. [1]

(d) What is the purpose of Plant B in the experiment? [1]

32 Read the statements carefully.

Letter	Statement
N	The blood has no oxygen.
P	The blood is rich in oxygen and carbon dioxide.
Q	The blood is rich in carbon dioxide.
R	The blood is rich in oxygen.

(a) The diagram below shows the human circulatory system. Fill in the correct letters in the boxes. [2]

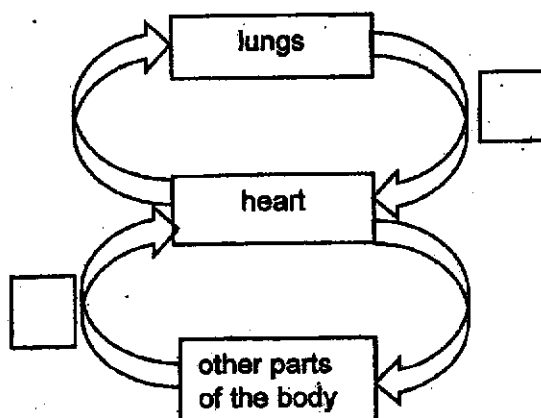

(b) Describe the process that happens in the lungs. [1]

The diagram below shows the circulatory system of a fish.

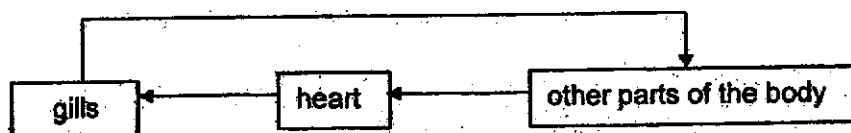

(c) State a difference between the flow of blood in fish and in human. [1]

33 The graph below shows Peter's breathing recorded during a period of two minutes.

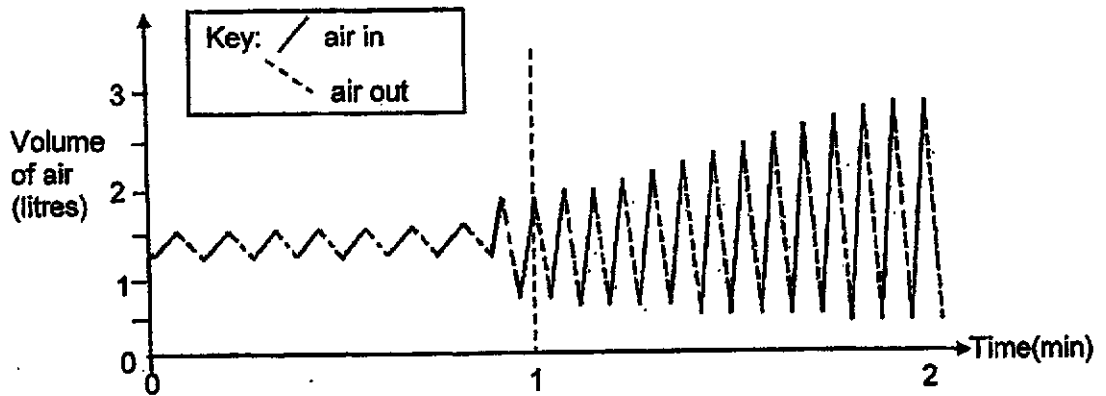

(a) What are the two changes in Peter's breathing before and after the first minute? [2]

(i) _____

(ii) _____

(b) Peter started exercising after one minute. Explain why there is a change in his breathing. [2]

34 The diagram below shows a grape flower.

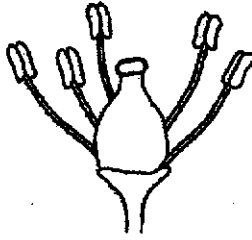

(a) Name a part, normally found in other flowers, that is not present in this flower. [1]

(b) Is this flower pollinated by wind or insects? Give a reason for your choice. [1]

The figure below shows the cross-section of a fruit that develops from the same flower.

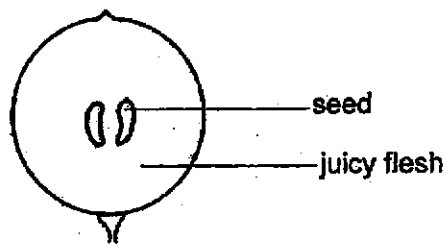

(c) Explain how the seed is dispersed. [1]

35 Betty set up a circuit below with bulbs K, L and M.

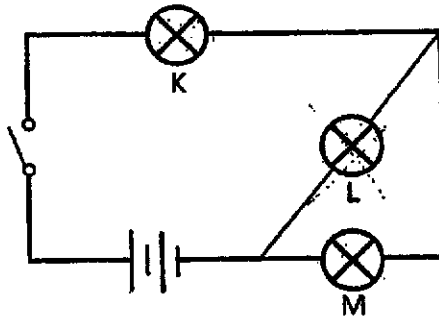

The three bulbs light up when the switch is turned on.

(a) Which bulb(s) has the same brightness as bulb L? [1]

(b) Which bulb(s) will still light up if bulb L fuses? Explain your answer. [2]

- 36 Liam conducted an experiment using identical bulbs and batteries. He set up two different circuits, S and T, and recorded his results in the table below.

Number of bulbs in circuit	Brightness of bulbs in circuit S (units)	Brightness of bulbs in circuit T (units)
2	3	1.5
3	3	1

- (a) Using three batteries and two bulbs for each circuit, draw a circuit diagram in each of the box below to show how the bulbs in circuits S and T are arranged. [2]

circuit S	circuit T

- (b) Explain your choice of bulb arrangement for circuit S. [1]

- (c) State an advantage of circuit T compared to circuit S. [1]

- 37 The diagram below shows a device that can be turned like a knob. The user will hold material K when turning the knob. Material K and J are joined and will turn together at the same time, while material G is in a fixed position.

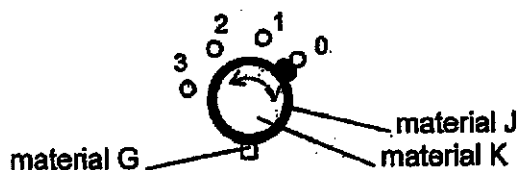

A circuit is constructed with the device and a hot plate. The device can be turned to make the hot plate hotter or less hot.

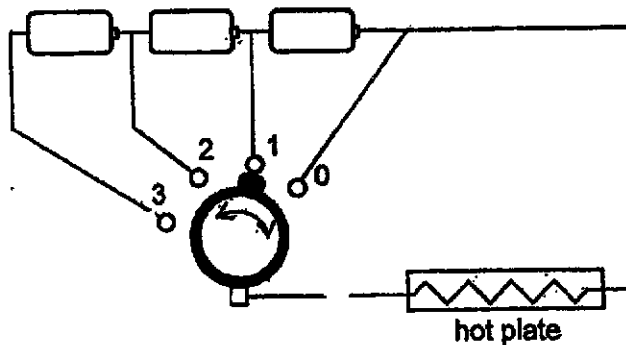

- (a) Suggest a property that each material G, J and K must have for it to work in the circuit above and is safe for the user. [2]

Property of material G:

Property of material J:

Property of material K:

- (b) What would happen to the hot plate when the knob is turned anti-clockwise from position 0 to position 1? [1]

- (c) What would happen to the hot plate if the knob is turned to position 2 instead of position 1? Explain your answer. [2]

- 38 Kayla used three similar towels, A, B and C 30g in mass, to investigate the rate of evaporation of water at different wind speeds.

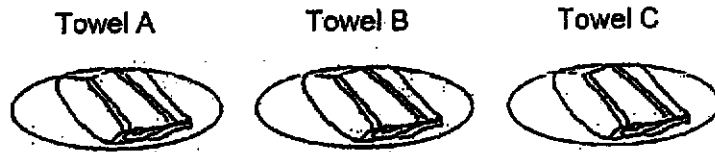

The conditions and the time taken for water to evaporate were recorded in the table below.

Towel	Temperature of water (°C)	Presence of wind	Time taken for the towel to dry completely (minutes)
A	28	No wind	50
B	28	Windy	35
C	28	Very windy	20

- (a) Suggest how Kayla can know that the towels are completely dry. [1]

A wet towel is often placed on the forehead when a person runs a fever.

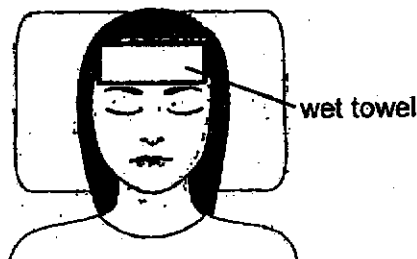

- (b) Explain how placing a wet towel helps a person to cool down. [2]

39 The figure below shows a beaker of water.

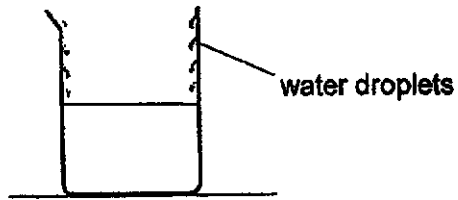

(a) Based on the observation of water droplets, does the beaker contain hot or cold water? Explain your choice. [2]

(b) After two hours, the water droplets on the beaker disappeared. Explain what happened. [1]

40 (a) State the properties of matter. [2]

(b) The set-up below shows two balloons hanging horizontally on a balance.

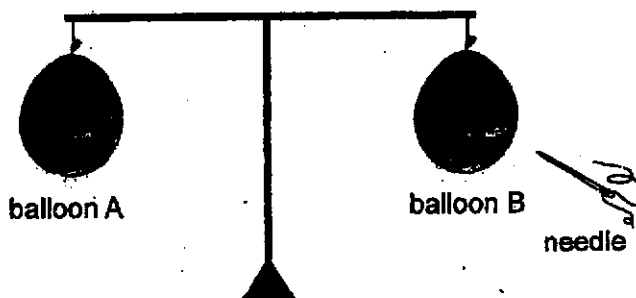

Larry used a needle to poke balloon B.

(i) What would happen to the balance after balloon B is poked. [1]

(ii) What does the observation in (b)(i) show about the property of air? [1]

End of paper

SCHOOL : ROSYTH SCHOOL
LEVEL : PRIMARY 5
SUBJECT : SCIENCE
TERM : 2020 SA2

SECTION A

Q 1	Q2	Q3	Q4	Q5	Q6	Q7	Q8	Q9	Q10
2	4	3	3	1	2	4	2	1	1
Q 11	Q12	Q13	Q14	Q15	Q16	Q17	Q18	Q19	Q20
2	3	4	4	4	2	3	1	3	3
Q 21	Q22	Q23	Q24	Q25	Q26	Q27	Q28		
4	4	1	2	3	2	1	3		

SECTION B

Q29)	<p>(a) Cell wall</p> <p>(b) Nucleus, cytoplasm</p> <p>(c) It has chloroplast to trap sunlight to make food</p> <p>(d) X has one chloroplast, but the leaf cell has more than 1 chloroplast. Leaf cell has a large central vacuole, but X does not have a vacuole.</p> <p>X has nucleus in the centre of the cell, but leaf cell has nucleus at the side.</p>
Q30)	<p>(a) They seed on the stem to obtain food from the food carrying tubes/water from water carrying tubes.</p> <p>(b) Water – carrying tubes. The roots absorb the pesticide together with water and the water carrying tubes in the stem transport it to the leaves.</p>

Q31)	<p>(a) Food made by Z</p> <p>(b) The stem holds the plant upright so the leaves can obtain sunlight to make food. It holds the leaves in place for the leaves to trap light and make food for the plant through photosynthesis.</p> <p>(c) The water drops into the soil for the roots to take in.</p> <p>(d) It is to compare and confirm that the availability of water to the roots is the only variable that affects the survival of plants.</p>
Q32)	<p>(a) Left: Q Right: R</p> <p>(b) Oxygen is absorbed into the blood and carbon dioxide is released.</p> <p>(c) Human has double circulation whereas fish has single circulation.</p>
Q33)	<p>(a) (i) His breathing rate increased (ii) The volume of air going in and the volume of air going out increased.</p> <p>(b) When he exercises, breathing rate increased to take in more oxygen to absorb into the bloodstream so that more oxygen is transported to the muscles to produce more energy.</p>
Q34)	<p>(a) Petal</p> <p>(b) It pollinated by wind as the anther are exposed in order for wind to carry the pollen.</p> <p>(c) The seed is dispersed by animals as it has juicy flesh which tempts animals to eat it. The seeds can be either too big to be swollen or indigestible. Indigestible seeds will be passed out as the animal moves, and thus it is being dispersed. If the seeds are too big to be eaten, the animal will eat the flesh and the seeds will drop onto the ground, thus it is dispersed.</p>

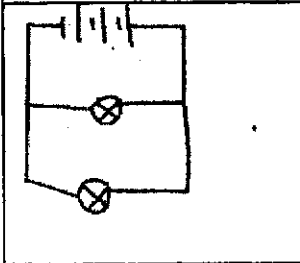
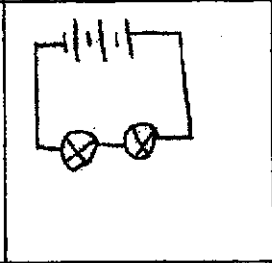
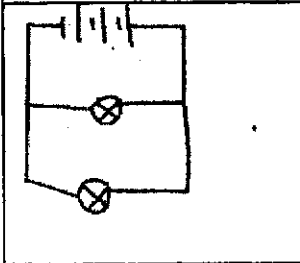
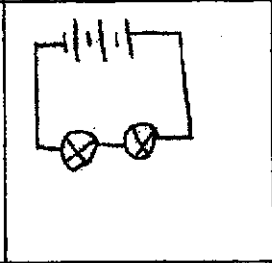
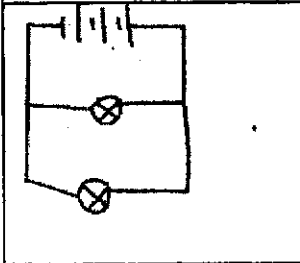
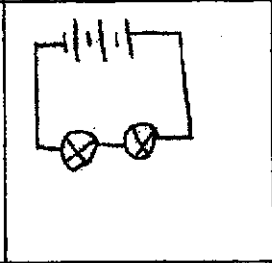
Q35)	<p>(a) K, M</p> <p>(b) K and M are still in a closed circuit for electricity to pass through the circuit.</p>				
Q36)	<p>(a) Answer</p> <table border="1" data-bbox="459 477 1031 790"> <thead> <tr> <th data-bbox="459 477 759 528">Circuit S</th> <th data-bbox="759 477 1031 528">Circuit T</th> </tr> </thead> <tbody> <tr> <td data-bbox="459 528 759 790">  </td> <td data-bbox="759 528 1031 790">  </td> </tr> </tbody> </table> <p>(b) Bulbs in a parallel circuit allows the brightness of the bulb remains the same as the number of bulb increases.</p> <p>(c) The bulbs in circuit T can be lit for a longer time than in circuit S.</p>	Circuit S	Circuit T		
Circuit S	Circuit T				
					
Q37)	<p>(a) G: Conductor of electricity J: conductor of electricity K: non – conductor of electricity</p> <p>(b) The hot plate will gain heat</p> <p>(c) The plate will be hotter, when the knob is turned to position 2, the circuit T has more batteries and more electricity will flow through the circuit to make the plate hotter.</p>				
Q38)	<p>(a) The towels are dry when the weigh 30g again.</p> <p>(b) Water in the towel gain heat from the forehead to evaporate. Thus, the body becomes cooler.</p>				
Q39)	<p>(a) The beaker contains hot water. Hot water evaporated and become hot water vapour. The hot water vapour cost heat to the cooler inner surface of the beaker gained heat and evaporated.</p> <p>(b) The water droplets gained heat and evaporated.</p>				
Q40)	<p>(a) All matter has mass and occupies space.</p> <p>(b) (i) it will tilt towards balloon A (ii) air has mass.</p>				

