



RAFFLES GIRLS' PRIMARY SCHOOL

SEMESTRAL ASSESSMENT (2)
2014

Section A	50
Section B	40
Your score out of 90	90
Parent's signature	

Name : _____ Index No: _____ Class: P 5 _____

20 October 2014 **SCIENCE** Attn: 1 h 30 min

SECTION A (25 X 2 marks)

For each question from 1 to 25, four options are given. One of them is the correct answer. Make your choice (1, 2, 3 or 4). Shade the correct oval on the Optical Answer Sheet.

1. The diagram below shows a process in the human reproduction system.

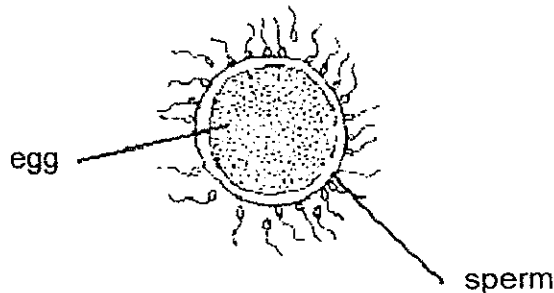

Which one of the following statements is true?

- (1) Only one sperm can fuse with an egg.
- (2) Only the egg contains hereditary information.
- (3) The fertilised egg would develop into two eggs.
- (4) The egg moves from the womb to the fallopian tube to meet the sperm.

2. The diagram below shows 3 generations of Alex's family that carry the genetic trait for disease X.

Someone could be just a carrier of the gene, without the disease occurring in him/her.

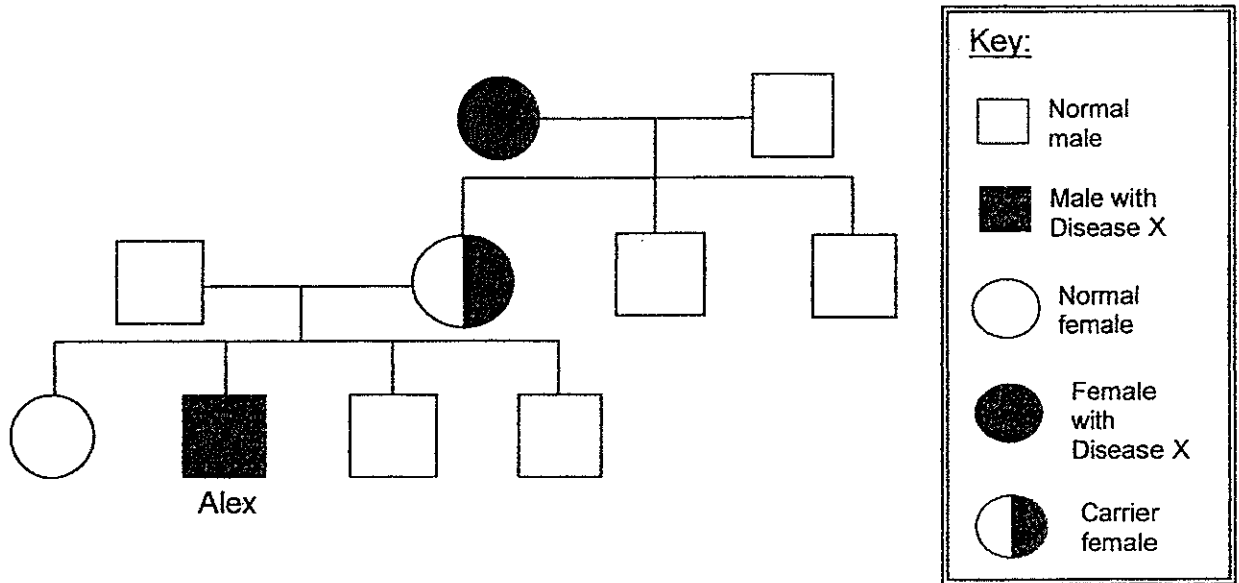

Based on the information above, which of the following statement(s) is/are likely to be correct?

- A Both of Alex's grandparents have disease X.
- B Alex's children could possibly inherit the disease.
- C Alex's mother inherited the genes of disease X from his grandmother.
- D The genes of disease X are passed on to only the female members of the family.

(1) A only

(2) B and C only

(3) A and C only

(4) B, C and D only

3. Siew Huay prepared two set-ups, X and Y, to investigate the conditions affecting seed germination. She placed the set-ups in a room with a constant temperature of 30°C.

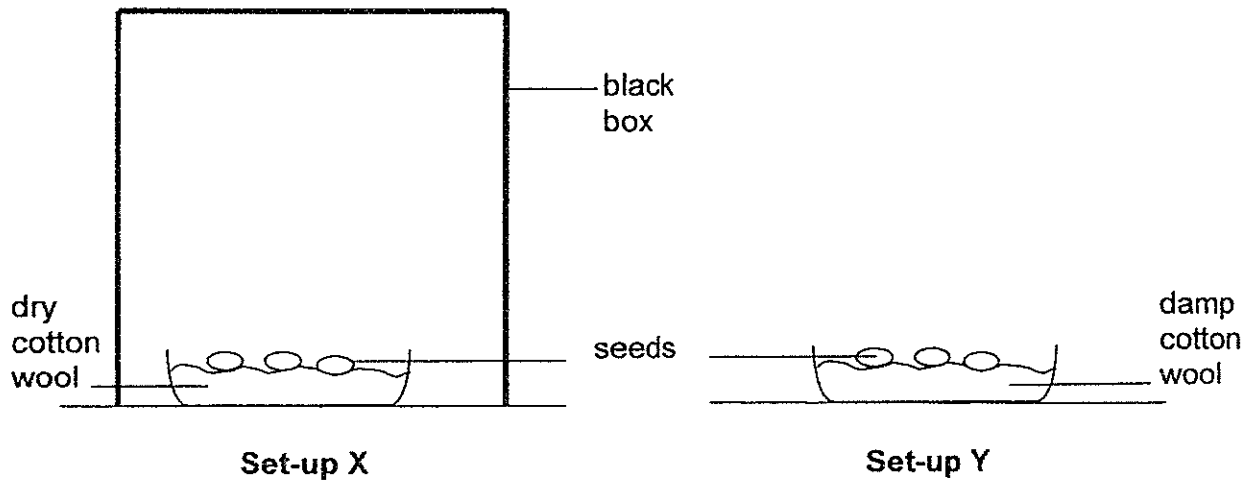

After 2 days, the seeds in Set-up Y germinated but the seeds in Set-up X did not.

4. Based on this experiment, which of the following is/are conditions required for seed germination that is/are present in Set-up Y but absent in Set-up X?

- A air
- B light
- C water
- D warmth

(1) A only

(2) C only

(3) B and C only

(4) A, C and D only

4. The diagram below shows a cross-section of a flower.

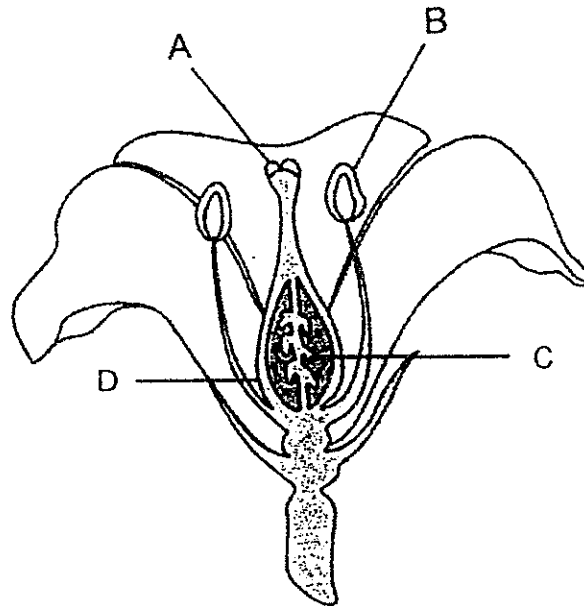

Cross-section of flower

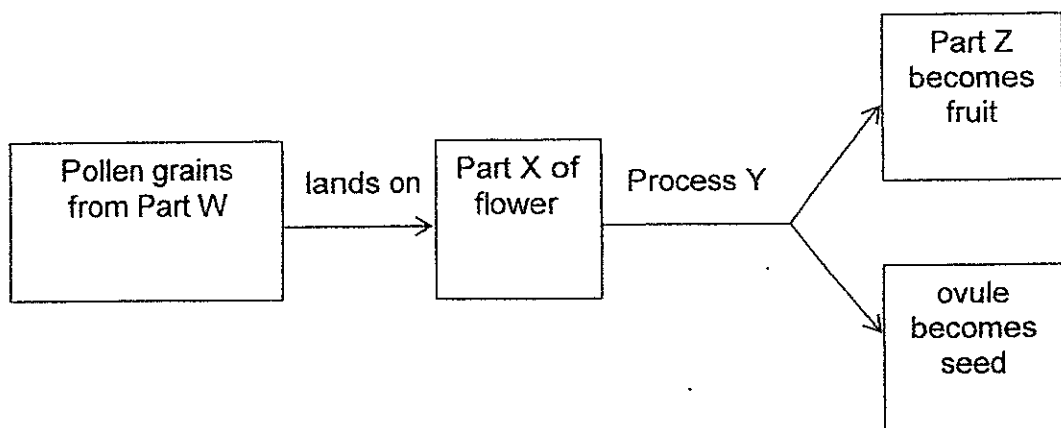

Which one of the following correctly represents W, X, Y and Z in the chart above?

	W	X	Y	Z
(1)	A	B	fertilisation	D
(2)	A	C	pollination	B
(3)	B	A	fertilisation	D
(4)	B	A	pollination	C

5. The table below shows the amount of food produced by four types of plants, A, B, C and D, under different light conditions.

Amount of light given (lux)	Amount of food produced (g) by :			
	Plant A	Plant B	Plant C	Plant D
500	15	2	9	1
1000	28	10	15	9
2000	45	40	37	32
4000	80	66	72	61

Based on the information above, which plant, A, B, C or D, will most likely be able to survive in the dark corner marked 'X' of the room below?

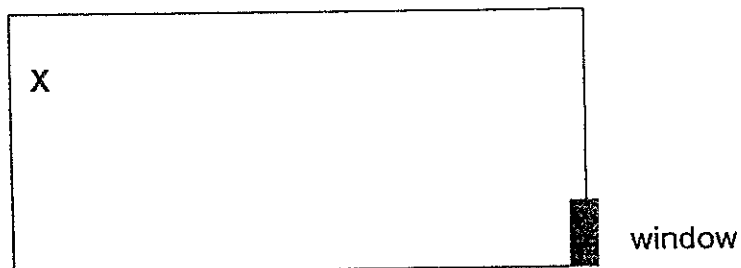

- (1) A
- (2) B
- (3) C
- (4) D

6. The diagram below shows the human digestive system.

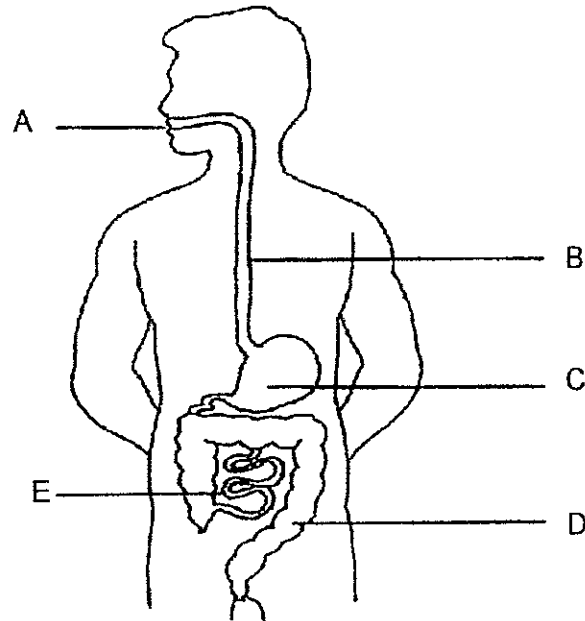

In which parts of the digestive system above does digestion take place?

- | | |
|---------------------|---------------------|
| (1) A and B only | (2) B, D and E only |
| (3) A, C and E only | (4) C, D and E only |

7. Lynn conducted an investigation to find out about the rate of heartbeats of different animals. She recorded her findings in the table below.

Organisms	Live Animal X	Dead Animal X	Live Animal Y	Dead Animal Y	Live Animal Z	Dead Animal Z
Number of heartbeats in 1 minute	400	0	150	0	30	0

Mass of the organism

- Animal X – about 20 g
- Animal Y – about 5 kg
- Animal Z – about 11 000 kg

Based on the information above, which of the following statements are true?

- A A dead animal has no heartbeat.
- B Animal X has the greatest number of heartbeats per minute.
- C An animal with a smaller mass has a slower heartbeat than an animal with greater mass.
- D The greater the mass of an organism, the fewer the number of heartbeats per minute.

(1) A and B only

(2) B and C only

(3) A and C only

(4) A, B and D only

8. Study the diagram of the three cells below.

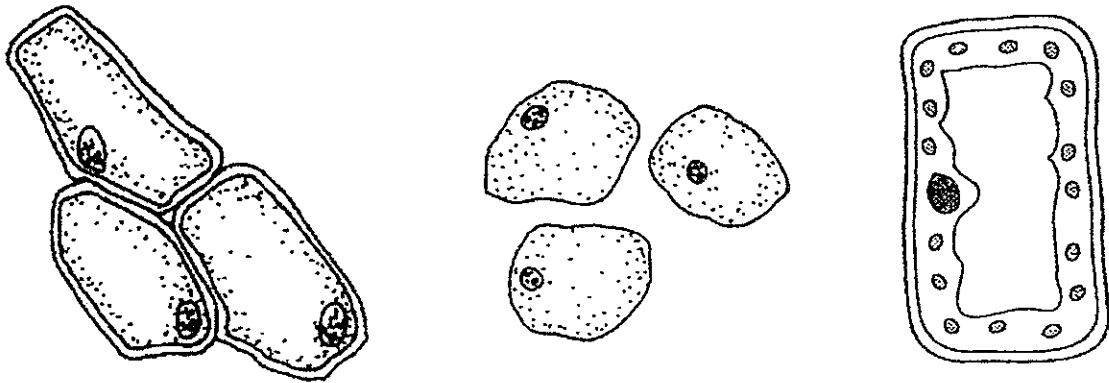

Which of the following parts are found in all the three cells above?

- (1) nucleus and cell wall
- (2) chloroplast and cytoplasm
- (3) nucleus, cell membrane and cytoplasm
- (4) nucleus, cell wall, cell membrane and cytoplasm

9. Which one of the following statements comparing the differences between human and fish respiratory and circulatory systems is incorrect?

	Human	Fish
(1)	Allows gaseous exchange between the lungs and the surrounding air	Allows gaseous exchange between the gills and the dissolved air in the water.
(2)	Air containing oxygen enters through the nose into the windpipe before going into the lungs.	Water contains oxygen enters through the gills chamber of the fish before going out through the mouth.
(3)	In the lungs are many air sacs surrounded by many blood vessels.	In the gills are many filaments that contain many blood vessels.
(4)	The heart pumps blood from the lungs to other parts of the body.	The heart pumps blood from the gills to other parts of the body.

Based on the information below, answer **questions 10 and 11**.

Kenny wanted to investigate the effect of drinking fizzy soft drink on his heart rate. A fizzy soft drink is a beverage that has had carbon dioxide dissolved into it.

He began the experiment by measuring his heart rate 6 minutes before drinking a cup of fizzy soft drink and recorded the results in the graph below.

The graph below shows his heart rate at every 2-minute interval for a duration of 20 minutes.

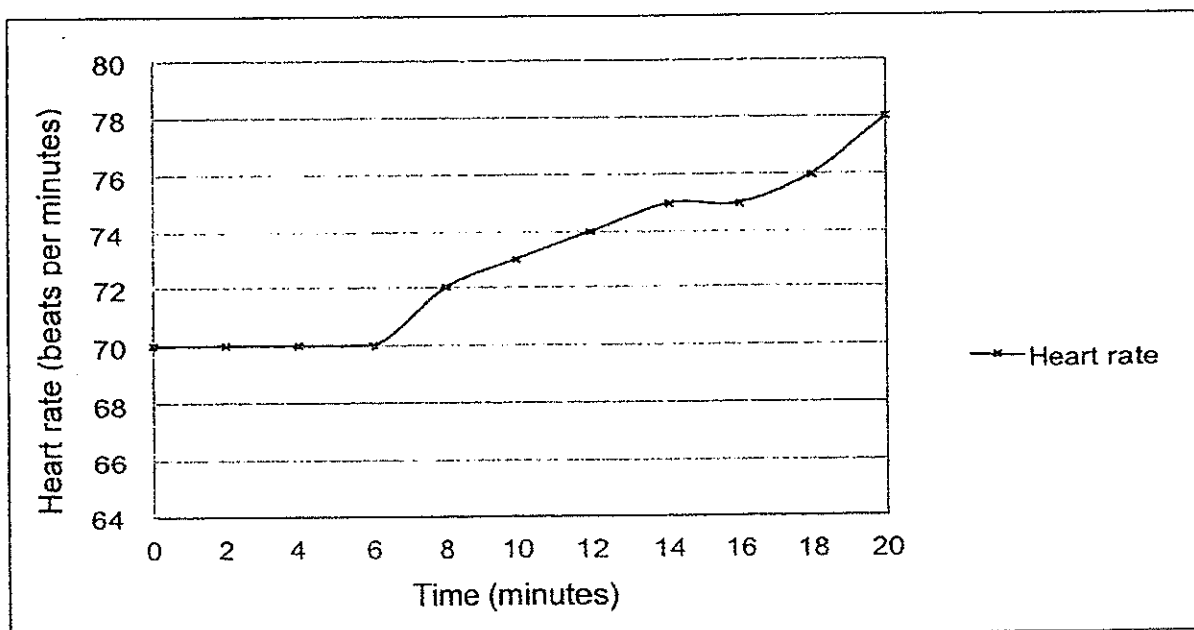

10. What of the following should not be carried out by Kenny during his experiment?

- A Repeat the experiment at least 3 times.
- B Drink water at the 10th-minute of the experiment.
- C Climb flights of stairs after he has drunk the fizzy drink.

- (1) A only
- (2) B only
- (3) B and C only
- (4) A, B and C

11. Based on the information provided in the graph, which of the following statements is/are correct?

- A Drinking fizzy soft drink increased his heart rate.
- B His heart rate started to increase 6 minutes after drinking the fizzy drink.
- C His heart rate started to decrease 10 minutes after drinking the fizzy drink.

- (1) A only
- (2) B only
- (3) A and B only
- (4) B and C only

12. Tammy wanted to find out if the roots of the plant absorb water. She set up an experiment as shown in the diagram below.

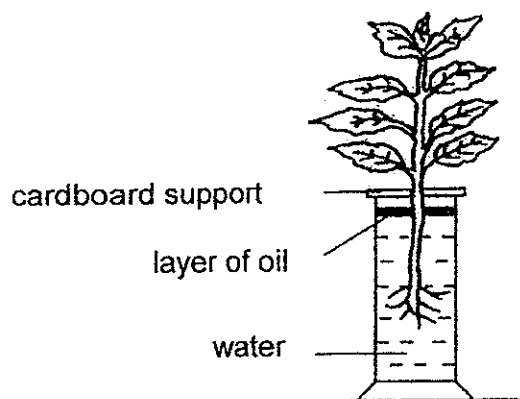

Which of the following should she choose as a control set-up for her experiment?

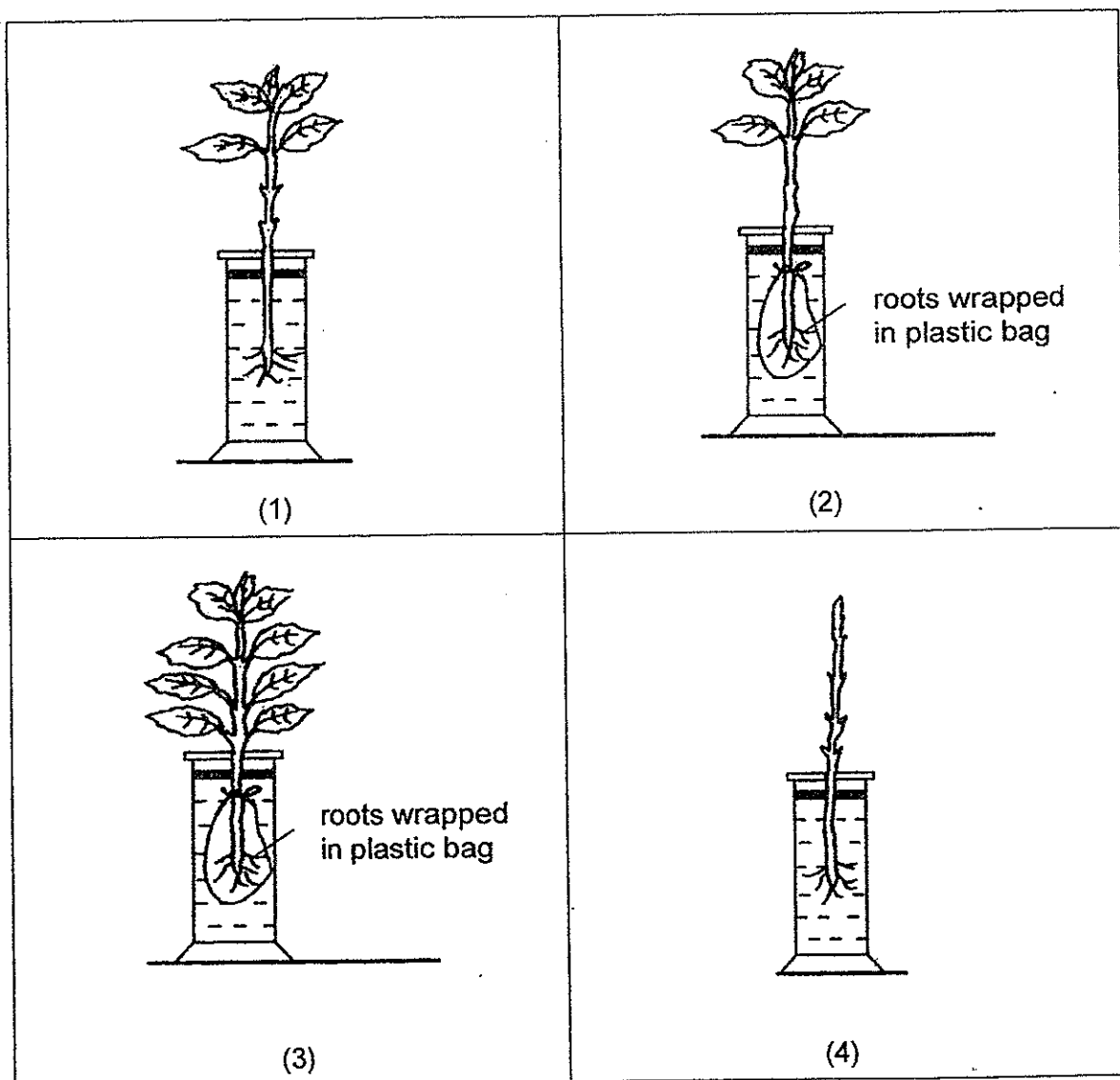

13. The diagram below shows how water and food are transported to different parts of a plant, namely parts A, B, C and D.

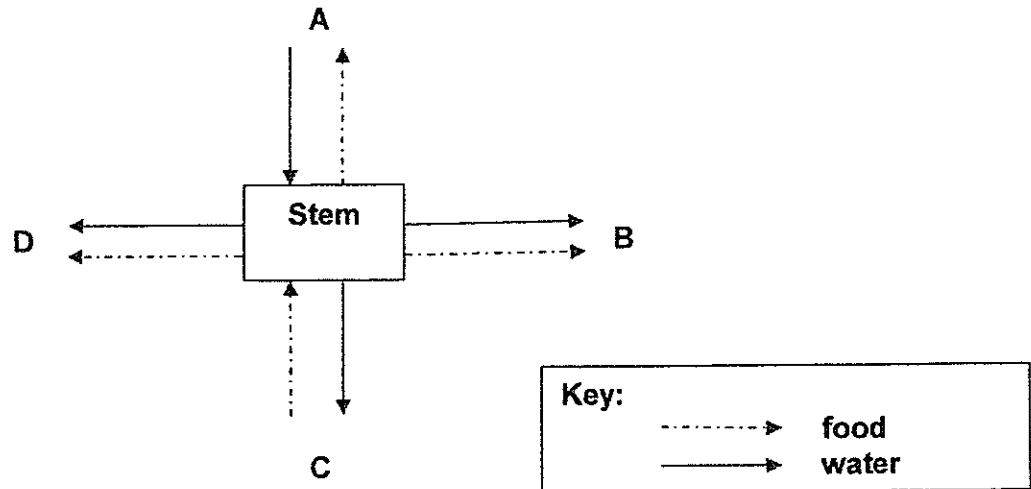

Which parts of the plant do A, B, C and D represent?

	A	B	C	D
(1)	leaves	fruit	flower	roots
(2)	roots	leaves	fruit	flower
(3)	leaves	fruit	roots	flower
(4)	roots	flower	leaves	fruit

14. Four pupils carried out an experiment by removing an outer ring of the stem between positions X and Y of a plant as shown below.

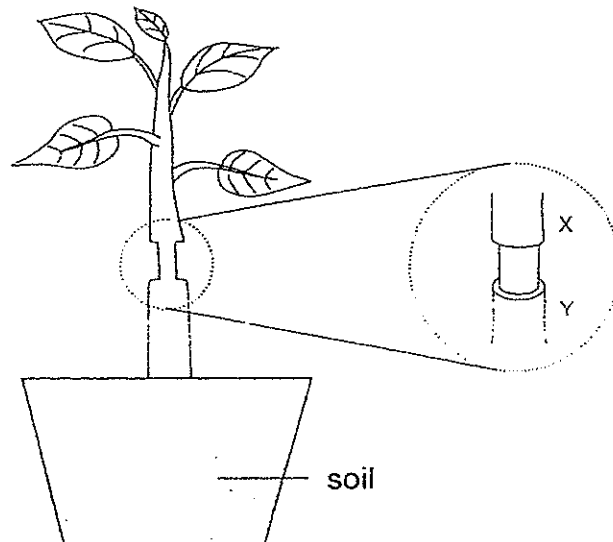

After some time, they noticed that the appearance of the stem has changed.

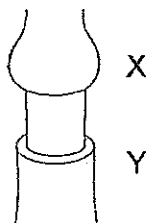

The four pupils, Wendy, Xiaoming, Yvette and Zoe, made the following statements about the appearance of the stem.

Wendy : The stem at position X is storing water only.

Xiaoming : The food carrying tubes between positions X and Y are removed.

Yvette : The tubes between positions X and Y are still carrying food and water.

Zoe : The water carrying tubes between positions X and Y remain in the stem.

Which of these pupils' statements were most likely to be correct?

- (1) Wendy and Xiaoming only
- (2) Yvette and Zoe only
- (3) Xiaoming and Zoe only
- (4) Xiaoming, Yvette and Zoe only

15. Which of the following are results of condensation?

- A Wet laundry drying in the sun.
- B A pot of cold water heating up on a stove.
- C A cloud appearing when the door of the freezer was opened.
- D Water droplets appearing on the mirror in the bathroom when hot water was turned on.
- E Perspiration disappearing from Tom's forehead when he sat down to rest after a run.

- (1) A and B only (2) C and D only
(3) B, C and E only (4) A, D and E only

16. The table below shows the state which each of the substances, W, X, Y and Z, exists in at various temperature.

Substance / Temperature	5° C	60° C	100° C
W	solid	liquid	gas
X	solid	gas	gas
Y	liquid	liquid	liquid
Z	liquid	liquid	gas

Which one of these substances, W, X, Y and Z, is most likely to be water?

- (1) W (2) X
(3) Y (4) Z

17. Sarah placed objects A and B between a torch and a white screen as shown below.

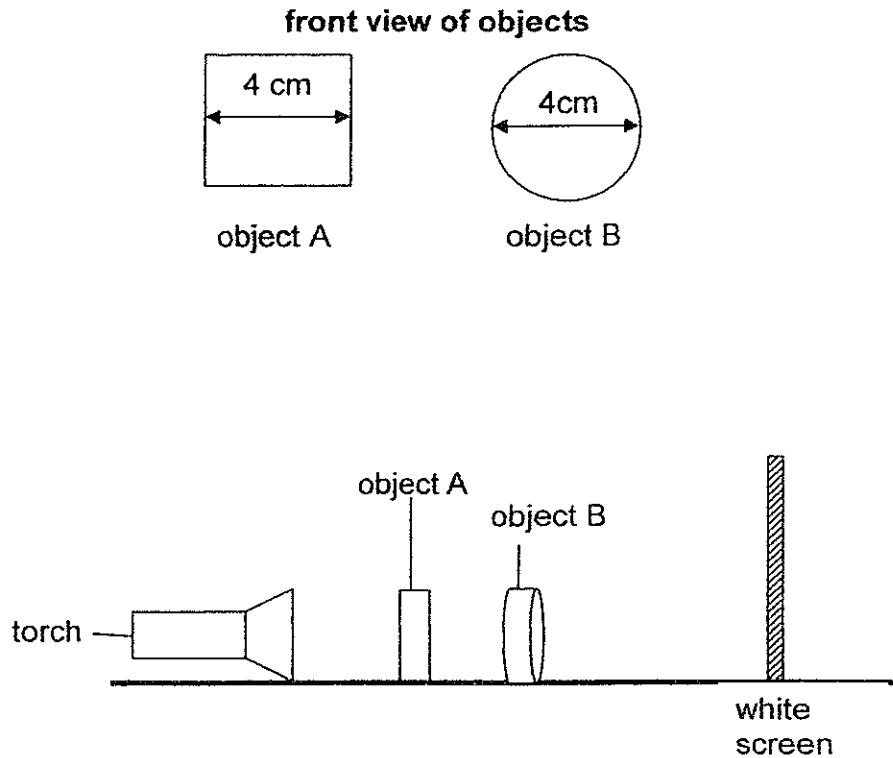

She recorded the shadow cast on the screen in the diagram below.

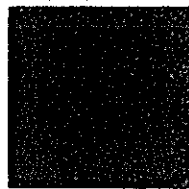

Based on the information above, which one of the following sets of materials could objects A and B possibly be?

	Object A	Object B
(1)	clear glass	frosted glass
(2)	frosted glass	steel
(3)	wood	ceramic
(4)	clear plastic	glass

18. The diagram below shows four children, P, Q, R and S. They are standing along different corridors.

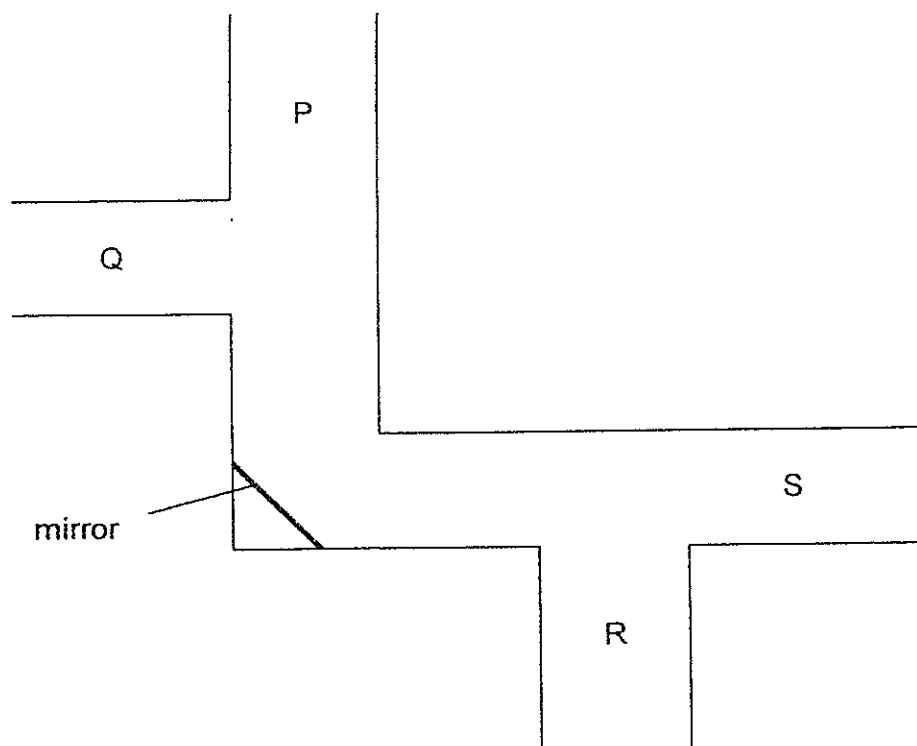

Which pair of children will be able to see each other in the mirror?

- | | |
|-------------|-------------|
| (1) P and R | (2) P and S |
| (3) Q and S | (4) Q and R |

19. Faris set up an experiment using four identical plastic cups as shown in the diagrams below.

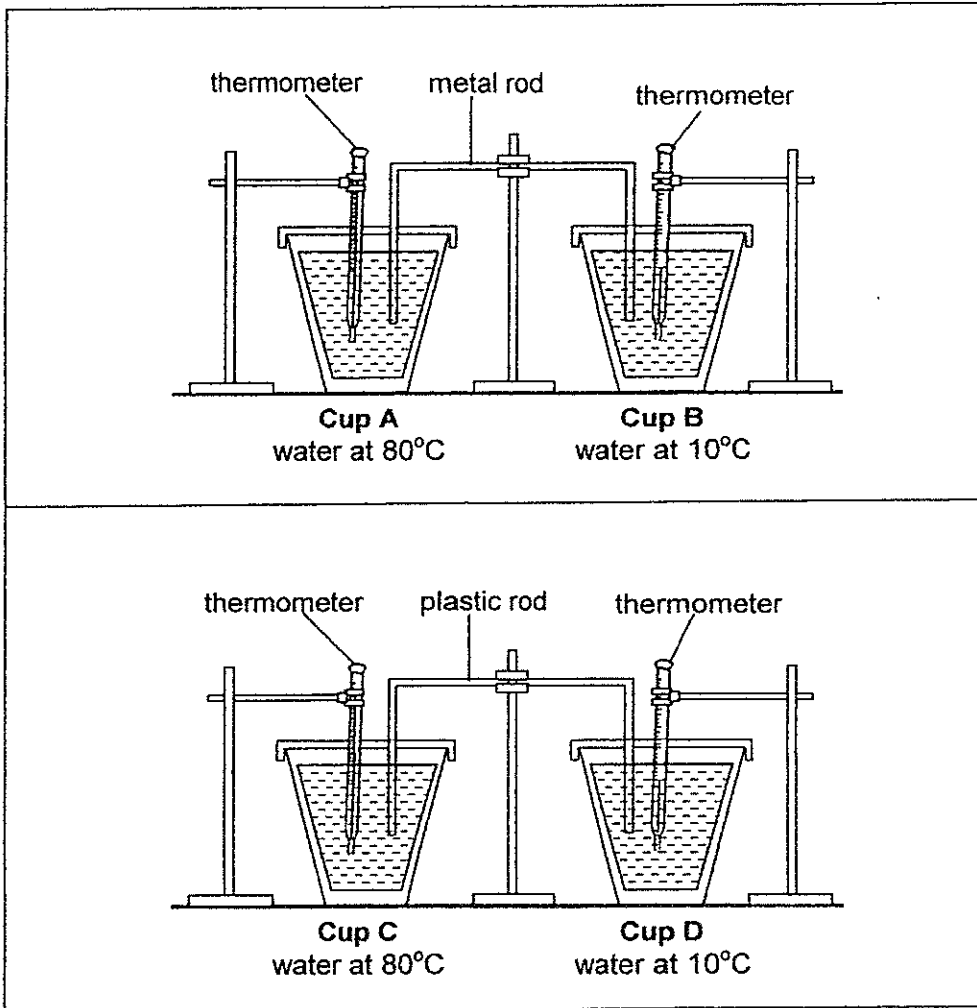

Three minutes after the start of the experiment, Faris recorded the temperature of the water in each cup.

Which one of the following shows the correct arrangement of the cups containing water from the highest temperature to the lowest temperature?

	highest temperature		lowest temperature	
	—————→			
(1)	A	C	B	D
(2)	A	C	D	B
(3)	C	A	B	D
(4)	C	A	D	B

20. Jun Teng conducted an experiment as shown in the diagram below.

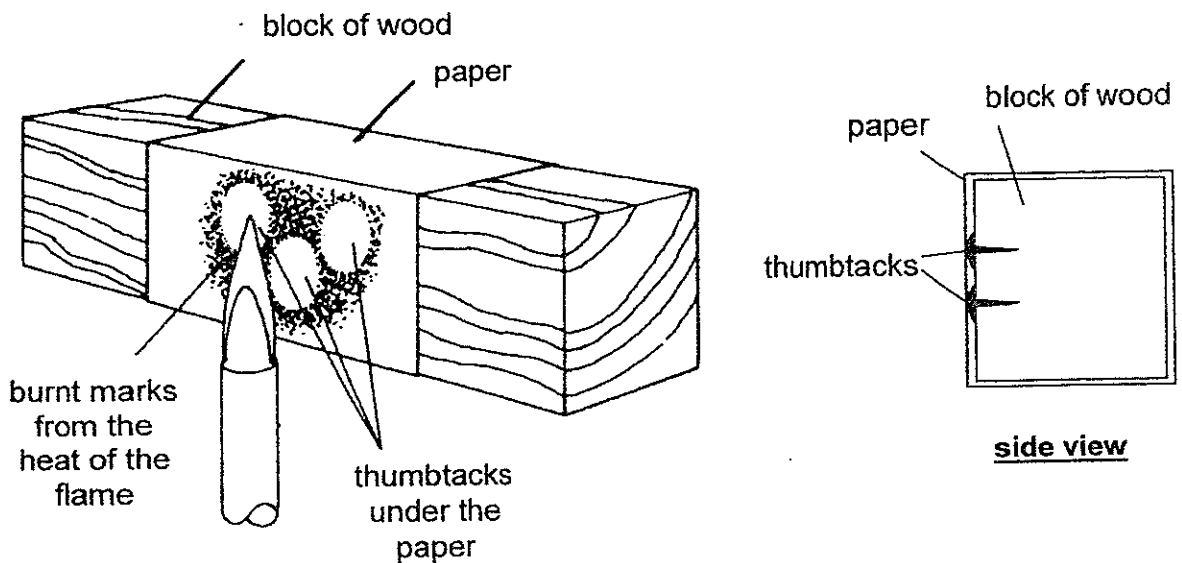

At the end of the experiment, Jun Teng observed that the flame burnt the part of the paper that covered the block of wood but **NOT** the part of the paper that covered the thumbtacks.

Which of the following statements explain Jun Teng's observations correctly?

- A Wood is a poor conductor of heat as it conducted heat away from the paper to the surroundings slowly.
- B Wood is a good conductor of heat as it conducted heat away from the paper to the surroundings quickly.
- C The thumbtack is a poor conductor of heat as it conducted heat away from the paper to the surroundings slowly.
- D The thumbtack is a good conductor of heat as it conducted heat away from the paper to the surroundings quickly.

(1) A and C only

(2) B and C only

(3) A and D only

(4) B and D only

21. Study the electric circuits below.

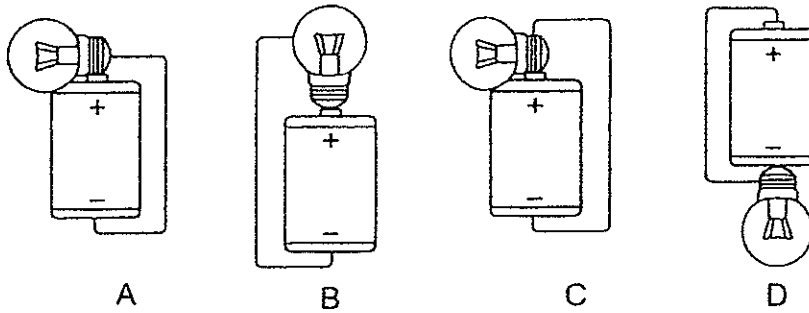

In which of the electric circuits will the bulb NOT light up?

- (1) A and D only
- (2) A, C and D only
- (3) B and C only
- (4) B and D only

22. Sarah set up the circuit as shown in the diagram.

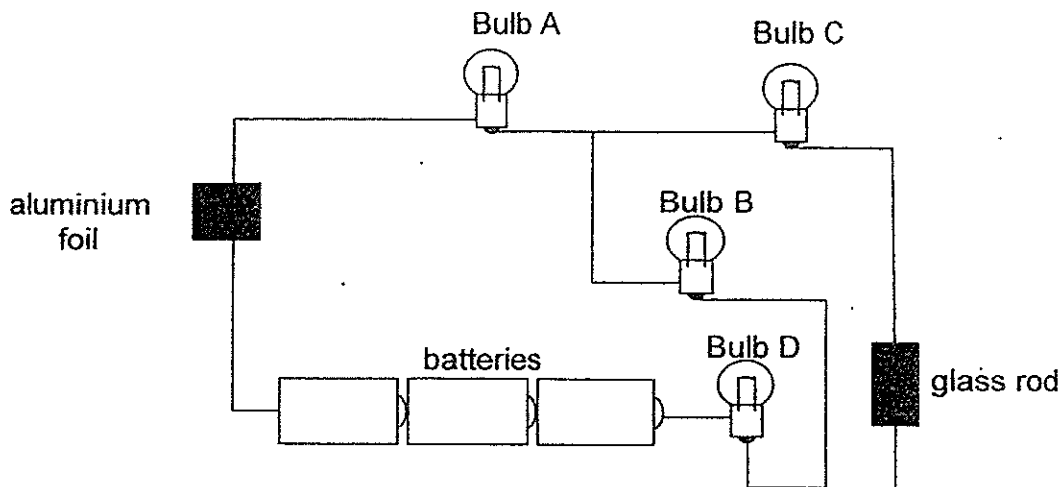

Which of the following bulbs will light up when all the circuit components are connected properly?

- (1) A and B only
- (2) A, B and D only
- (3) A, C and D only
- (4) B, C and D only

23. Daniel set up the circuit as shown in the diagram.

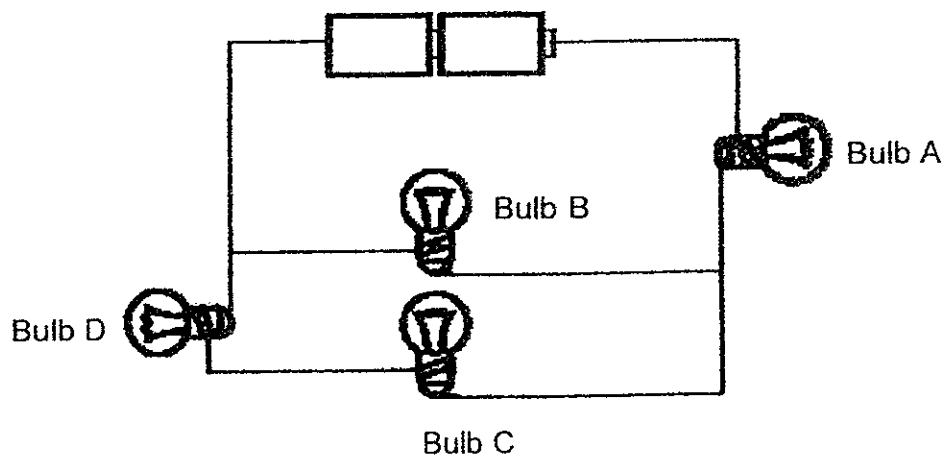

Which of the following bulb(s) when fused will result in only 2 bulbs remaining lit?

- (1) A only
- (2) B and C only
- (3) B and D only
- (4) C and D only

24. The diagram below shows a circuit card and a circuit tester.

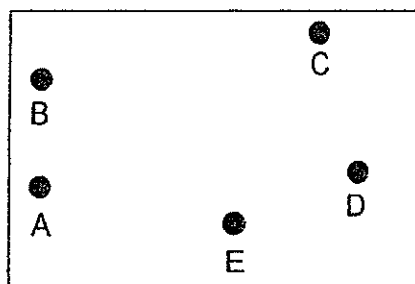

circuit card

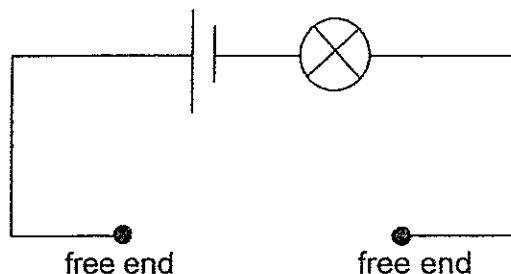

circuit tester

The table below shows what happens to the bulb when each of these points on the circuit card is connected to one free end of the circuit tester.

Points connected to the free ends of circuit tester	Does the bulb light up?
A and B	Yes
A and C	Yes
B and D	No
B and E	Yes
C and D	No

Based on the information given in the table above, which of the following shows the correct arrangement of the wires on the circuit card?

(1)

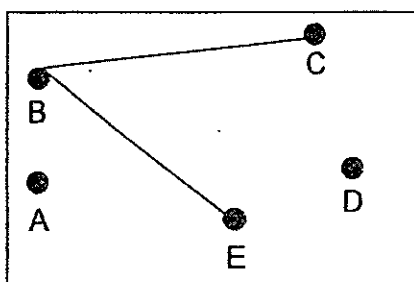

(2)

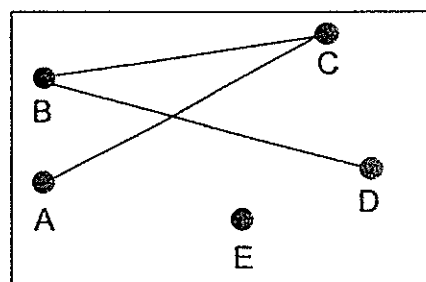

(3)

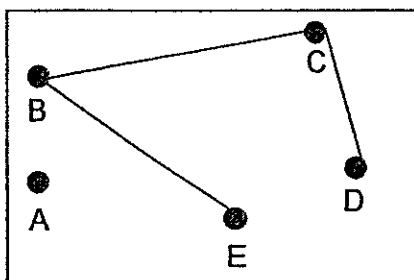

(4)

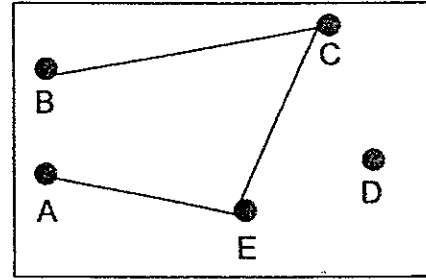

25. Kenny tested for interaction between 3 metal bars, A, B and C, with their ends labelled R to W as shown below.

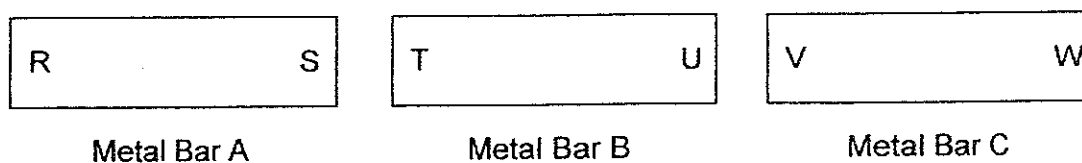

He made the following observations.

- A: When R is brought close to T, Metal Bars A and B moved towards each other.
- B: When T is brought close to V, Metal Bars B and C moved away from each other.
- C: When W is brought close to R, Metal Bars A and C moved towards each other.

Based on his observations above, which one of the following is definitely correct in describing the three metal bars tested by Kenny?

	Metal Bar A	Metal Bar B	Metal Bar C
(1)	magnetic material	non-magnetic material	magnetic material
(2)	magnet	magnet	magnet
(3)	magnet	magnetic material	non-magnetic material
(4)	magnetic material	magnet	magnet

Name: _____ Index No: _____ Class: P5 _____

SECTION B (40 marks)

For questions 26 to 39, write your answers clearly in the spaces provided.
The number of marks is shown in brackets [] at the end of each question or part question.

26. The diagram below shows both a plant and a human male reproductive system.

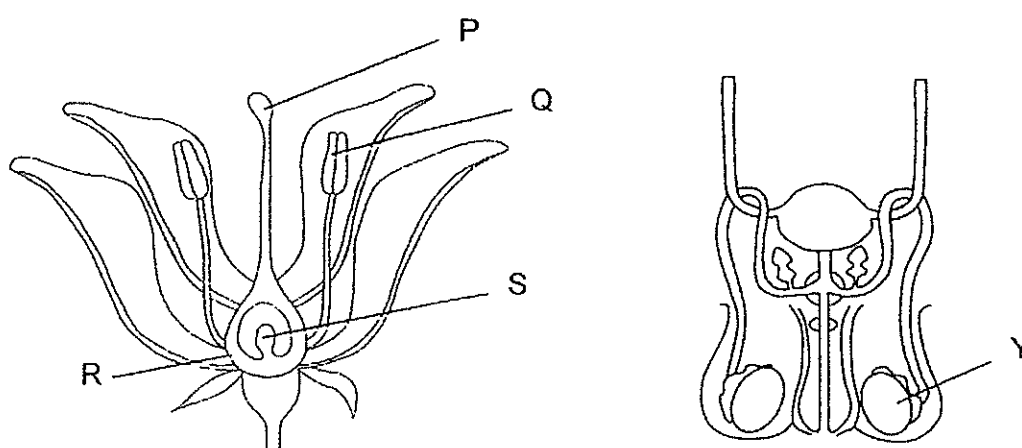

(a) Name the part of the human male reproductive system that has the same function as part R. [1]

(b) (i) Which of the above parts, P, Q, R or S, has the same function as part Y in the male human reproductive system? [1]

(ii) State the function of part Y. [1]

Score	3
-------	---

27. The diagram below shows two fruits, A and B, of different plants.

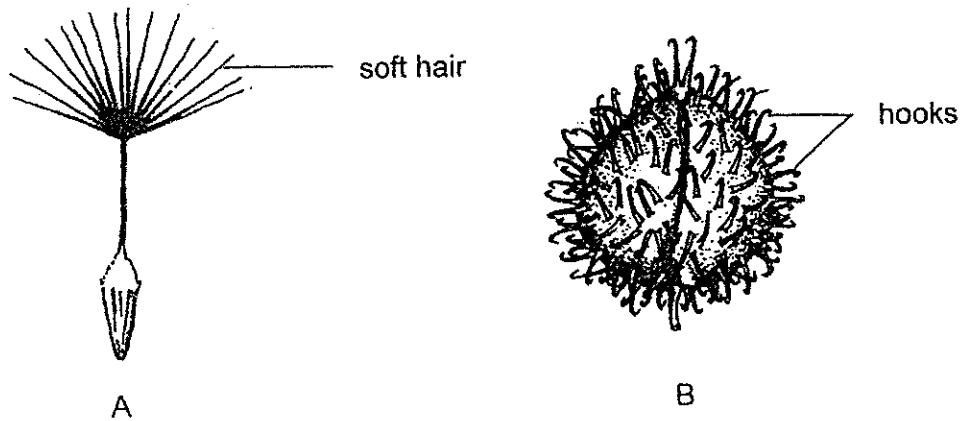

- (a) Which fruit, A or B, is likely to be dispersed by an animal? [2]
Give a reason for your answer.

- (b) Give one advantage of seed dispersal for the plant. [1]

Score	
	3

28. Lissy wanted to show that plants need light to make food. She set up the experiment below and put the potted plants in a dark room.

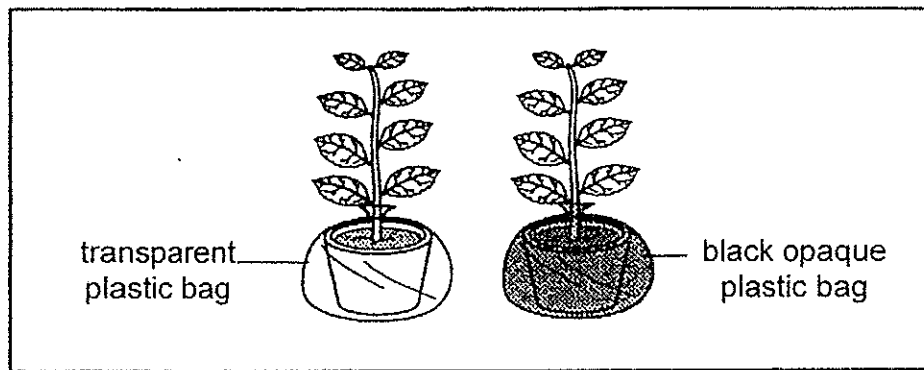

Lissy's teacher told her that she must make 2 changes to her experiment for it to work.

- (a) State the 2 changes Lissy should make. [2]

Change 1: _____

Change 2: _____

- (b) State the independent variable in Lissy's experiment. [1]

Score	
	3

29. Jerome conducted an experiment to find out whether meat X or meat Y is digested at a faster rate. He set up his experiment as shown in the diagram below.

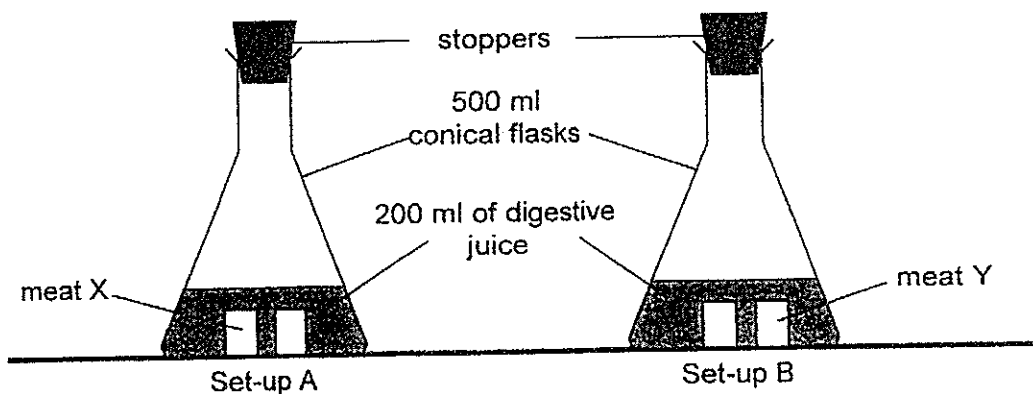

- (a) Name **ANOTHER 2** variables he should keep constant for a fair test. [2]

Variable 1	
Variable 2	

- (b) What should Jerome do to determine which meat, X or Y, is digested at a faster rate? [1]

Score	3
-------	---

30. The diagram below shows how some cells could be classified.

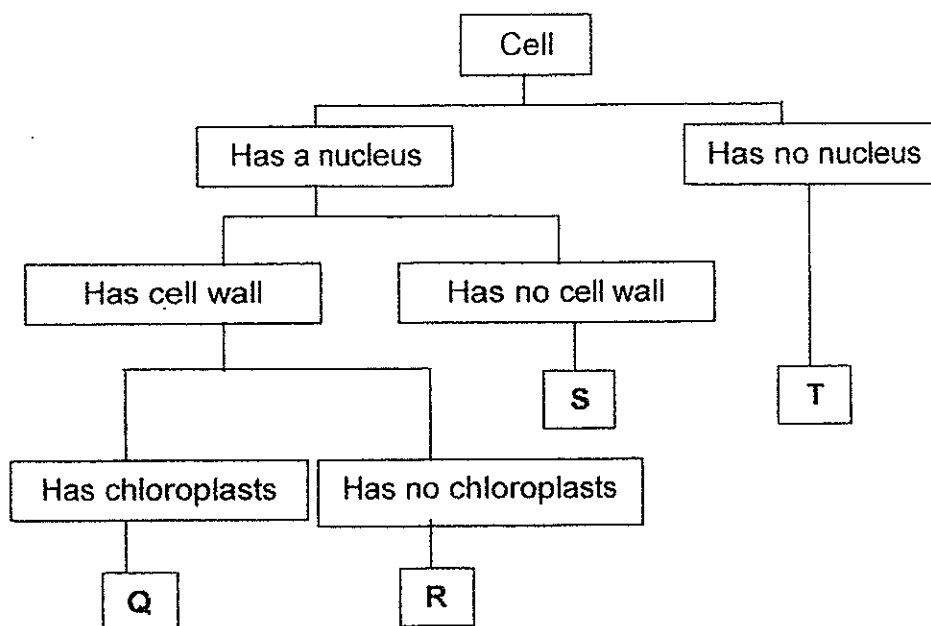

Based on the information above, answer the following questions.

(a) State one difference between cell Q and cell S. [1]

(b) Give an example of a cell Q. [1]

(c) Which cell is likely a root cell? Explain your answer. [1]

Score	3
-------	---

31. The diagram below shows the circulation of blood in the human body.

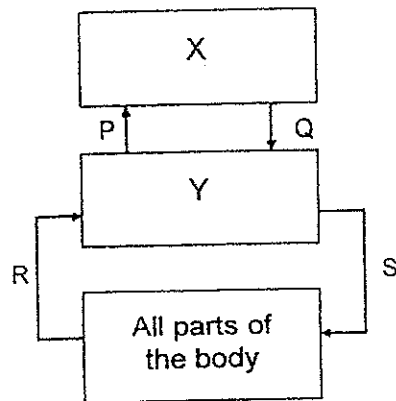

(a) Name the organs that X and Y represent. [1]

X: _____

Y: _____

(b) Which part, P, Q, R or S, represents blood vessels that have the highest level of oxygen? Give a reason for your answer. [1]

Score	2
-------	---

32. The graphs below shows the volume of air Susan breathed in and out before and during her exercise.

Before exercise

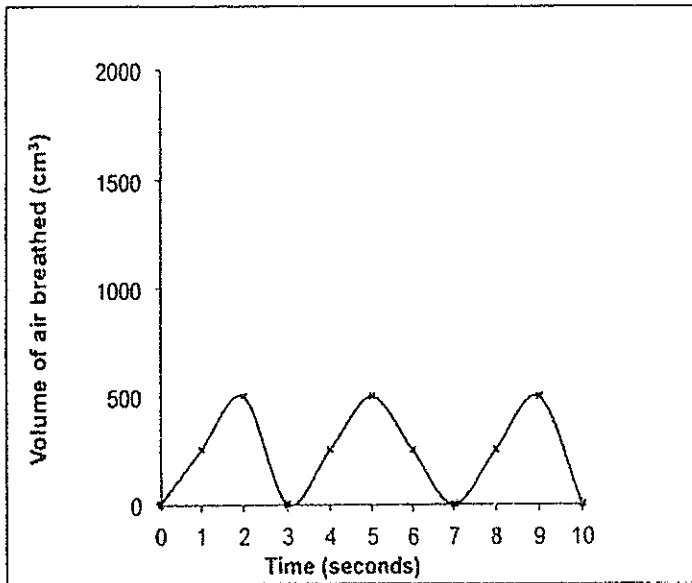

During exercise

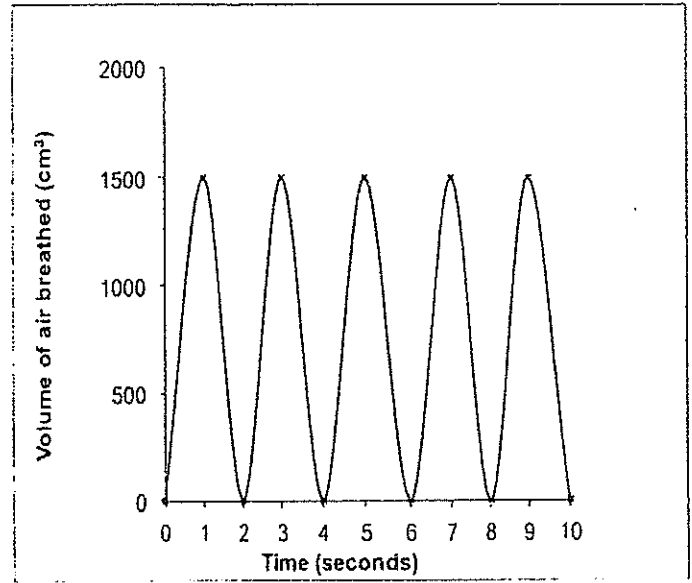

- (a) Based on the graph, how many more times did Susan inhale in the first 10 seconds of exercising? [1]

- (b) How much more volume of air did Susan breathe in each time while exercising? [1]

- (c) Explain why Susan breathed in more air while exercising. [1]

Score	3
-------	---

33. Steven placed three plants, A, B and C in three beakers, each with 500 ml of water and a layer of oil. Each plant has a different amount of roots.

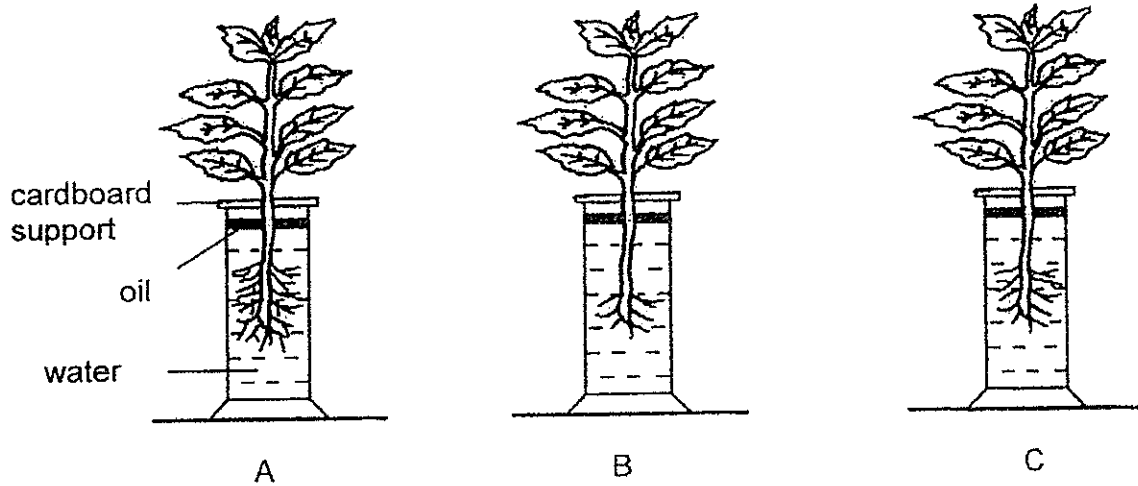

The table below shows the amount of water in each beaker after two days.

Plant	Amount of water in the beaker at the end of the experiment (ml)
A	350
B	480
C	400

- (a) What is the relationship between the amount of roots of a plant and the amount of water left in the beaker at the end of the experiment? [1]

- (b) Give a reason for your answer in part (a). [1]

Score	2
-------	---

34. Emma wanted to find out if the length of the wings of the toy seed model affects the time taken for it to reach the ground. She used the same type of paper to make the three models, A, B and C as shown below.

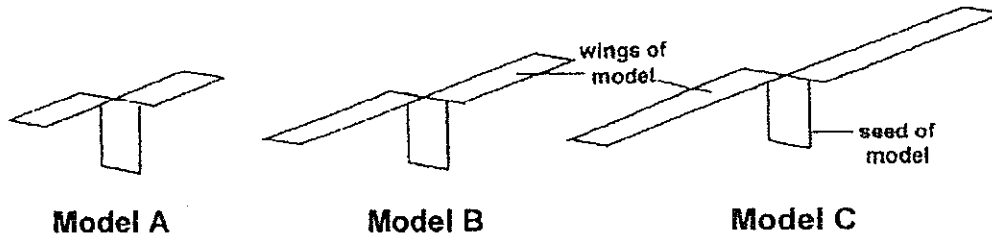

Emma varied the length of the wings of each model. She threw them from a height of 2 metres and recorded the time taken for each model to reach the ground. She repeated the experiment three times.

The results are shown in the table below.

	Time taken for model to reach the ground (s)			
	1 st reading	2 nd reading	3 rd reading	Average reading
Model A	3.2	3.3	3.1	3.2
Model B	4.8	4.6	4.4	4.6
Model C	5.8	5.9	5.4	5.7

- (a) Based on the information above, why did Emma repeat her experiment three times? [1]

- (b) What is the relationship between the length of the wings of each model and the time taken for the model to reach the ground? [1]

- (c) If the wings of the seed model A are removed, will the average time taken for the model to reach the ground be "3.2", "less than 3.2" or "more than 3.2" seconds?
Give a reason for your answer. [1]

Score	3
-------	---

35. Meiling heated a beaker of ice over a flame and measured the temperature of the contents in the beaker at 5-minute intervals. She recorded the temperature in the graph below.

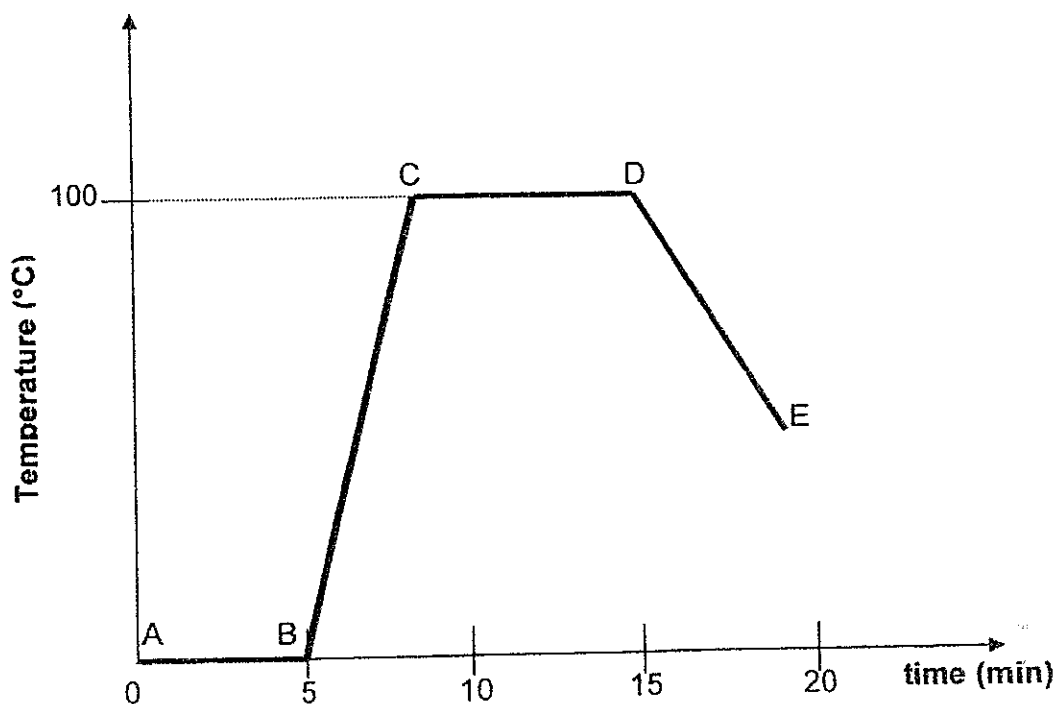

Based on the information above, answer the questions below.

- (a) Write 'heat gained' and 'heat lost' in the table below to indicate a gain or lost in heat at the various intervals in the graphs. [2]

	Intervals	Heat gain / Heat loss
(i)	AB	
(ii)	BC	
(iii)	CD	
(iv)	DE	

- (b) Without adding anything to the experimental set-up, suggest what would be the likely reason for the decrease in temperature from point D to point E? [1]

Score	3
-------	---

36. Raniya set up the following electrical circuit in her dollhouse.

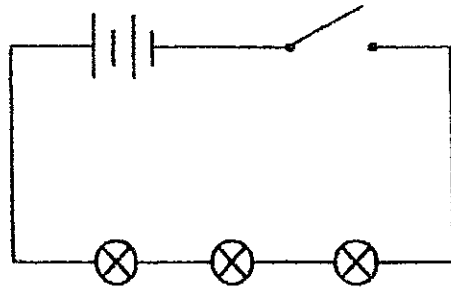

She found out that when the switch is turned on, all three bulbs would light up.

(a) Using 2 batteries, 2 bulbs, 2 switches and some wires, draw a circuit diagram in the box below that satisfy the following conditions:

- (i) one bulb will light up even though the other bulb has fused
- (ii) a bulb will light up each time when a switch is closed [2]

After Raniya had set up her electric circuit in her dollhouse, she observed that the bulbs did not light up even though the switches were closed. All the components in the circuit were functioning properly.

(b) Give a possible reason for her observation. [1]

Score	3
-------	---

37. The diagram below shows three circuits with different arrangements of identical batteries and bulbs. The bulbs in all three circuits light up.

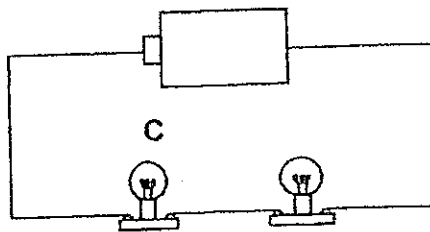
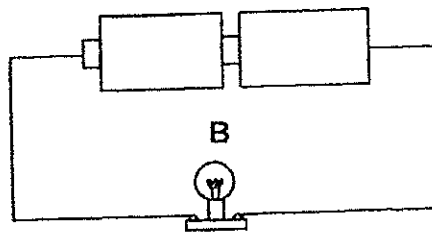
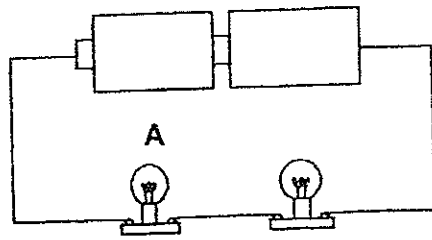

- (a) Arrange the bulbs, A, B and C, starting from the least bright to the brightest. [1].

_____ (brightest)

- (b) State 2 ways to increase the brightness of bulb C. [2]

(i) _____

(ii) _____

Score	3
-------	---

38. Muthu set up an experiment as shown in the diagram below.

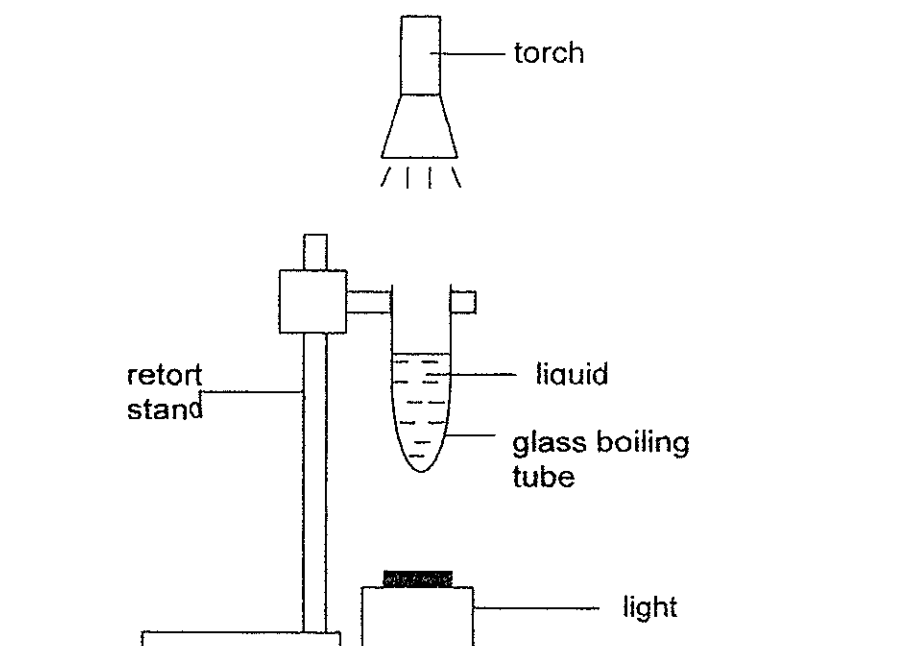

He prepared four boiling tubes, each containing a different liquid, A, B, C or D, of the same amount. He switched on the torch and recorded the amount of light detected by the light sensor for each liquid as shown in the table below.

Type of liquid	A	B	C	D
Amount of light detected (Lux)	1300	20	500	800

- (a) Which one of the liquids, A, B, C or D, would form the darkest shadow when light is being shone through it? Give a reason for your answer. [1]

- (b) Muthu then dropped a metal ball into 2 boiling tubes containing liquids A and C. In which liquid, A or C, would he be able to see the metal ball more clearly? Explain your answer. [2]

Score	3
-------	---

39. Jing Xuan prepared the set-up below to find out if steel bar X is a magnet.

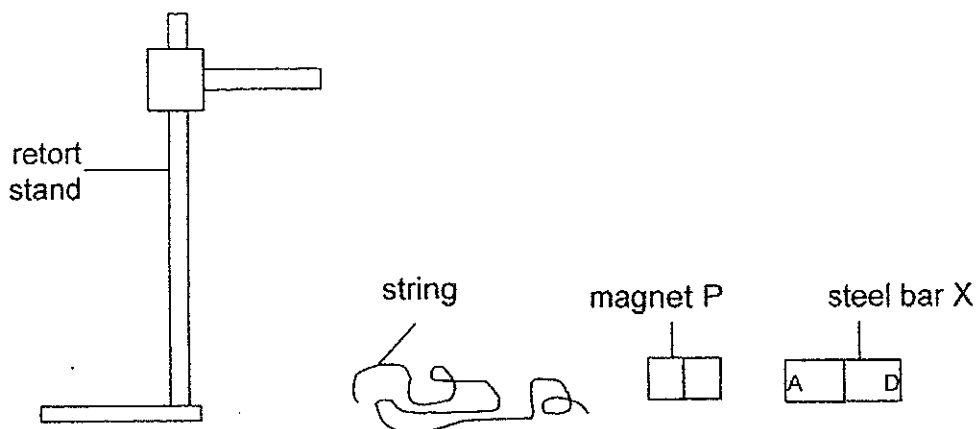

- (a) Using **all** the apparatus given above, draw to complete the diagrams below to show how Jing Xuan could find out if steel bar X was a magnet in 2 steps.

The retort stand has been drawn for you. Label your diagrams **clearly**. [2]

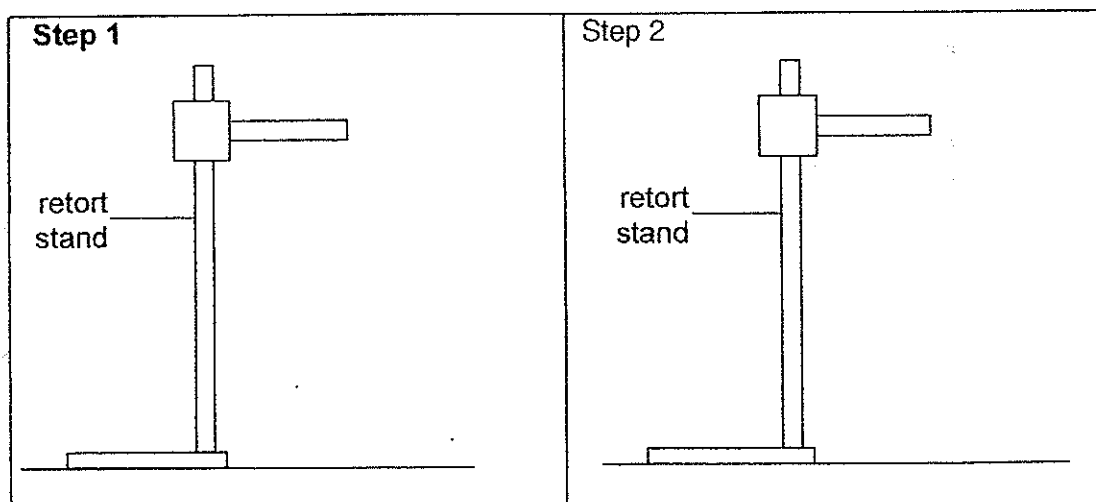

Jing Xuan discovered that bar X was a magnet. She then proceeded to find out which part of steel bar X has the greatest magnetic strength by hanging the entire bar at a distance away from a tray of ~~paper clips~~ iron filings.



- (b) Which part(s) of bar X, A, B, C or D, will attract the most amount of iron filings? Give a reason for your answer. [1]

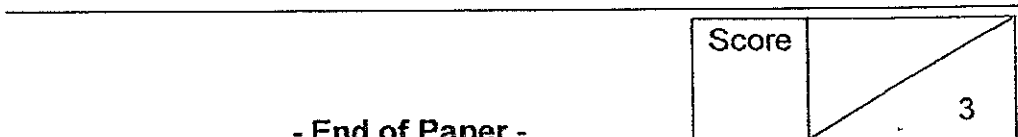
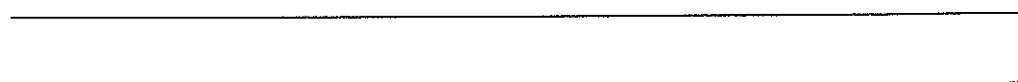

- End of Paper -

EXAM PAPER 2014

LEVEL : PRIMARY 5

SCHOOL : RAFFLES

SUBJECT : SCIENCE

TERM : SA2

Q1	1	Q6	3	Q11	1	Q16	4	Q21	3
Q2	2	Q7	4	Q12	3	Q17	2	Q22	2
Q3	2	Q8	3	Q13	4	Q18	2	Q23	4
Q4	3	Q9	2	Q14	3	Q19	3	Q24	4
Q5	1	Q10	3	Q15	2	Q20	3	Q25	4

Q26	(a)	Ovary
	(b)	Q
	(c)	It Produces sperms.
Q27	(a)	Fruit B. The hooks of the fruit cling on/hook on to the hair/fur of the moving animals to be carried (further) away from the parent plant.
	(b)	Young plant will not compete with parent plant for water. Nutrient, sunlight and space.
Q28	(a)	Any 2 answers (i) Put the black/opaque plastic bag over the leaves of only one of the plant. (ii) Put both plants in the light (iii) Remove both plastic bags (iv) Put one plant in the light.
	(b)	Any answer (i) Light (ii) Presence of light (iii) Sunlight (iv) Only one plant can receive sunlight
Q29	(a)	Variable 1: The amount of heat Variable 2: The amount of time
	(b)	He should measure the amount of meat left in each setup at the end of the experiment.
Q30	(a)	Cell Q has a cell wall but cell S does not.
	(b)	Leaf cell
	(c)	R. It does not photosynthesise
Q31	(a)	X : lungs Y : Heart
	(b)	Q. Oxygen taken in by/enters the lungs was absorbed into the bloodstream before it is transported by blood vessel Q to the heart. or Q. It transports blood from the lungs where gaseous exchange take place before it is transported to all parts of the body.

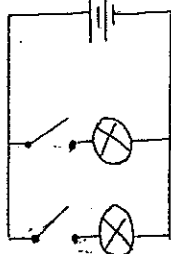
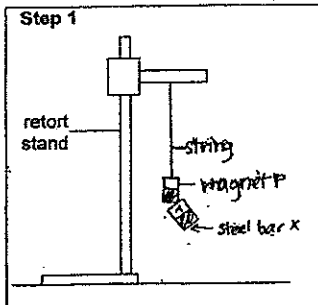
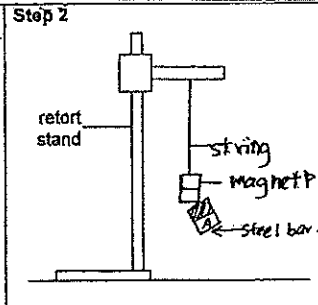
Q32	(a)	2 times
	(b)	1000cm ³
	(c)	Susan needs to take in/breathe in more oxygen to release more energy while she was exercising.
Q33	(a)	The greater the amount of roots of a plant, the lesser the amount of water left in the beaker at the end of the experiment.
	(b)	With more roots more water is taken in. <u>or</u> More water will be taken in when the plant has greater amount of roots.
Q34	(a)	To ensure that the results are reliable.
	(b)	The longer the length of the wings of each model, the longer the time taken for the model to reach the ground.
	(c)	Less than 3.2 seconds. There are no wings to enable model A to float longer in the air.
Q35	(a)	(i) – (iii) heat gain (iv) heat loss
	(b)	The flame was removed
Q36	(a)	
	(b)	The electrical components were not connected properly creating an open circuit. Batteries not arranged correctly resulting in an open circuit.
Q37	(a)	C, A, B
	(b)	(i) Add more batteries (ii) Remove one bulb
Q38	(a)	B. It is the least transparent.
	(b)	Liquid A. More light can pass through liquid A. Therefore, more light will be able to pass through the liquid to reach the ball and be reflected into his eyes.
Q39	(a)	<div style="display: flex; justify-content: space-around;"> <div style="text-align: center;"> <p>Step 1</p>  </div> <div style="text-align: center;"> <p>Step 2</p>  </div> </div>
	(b)	Part A and D. Magnetic strength is strongest at the poles which are parts A and D.

