



RAFFLES GIRLS' PRIMARY SCHOOL

SEMESTRAL ASSESSMENT 2

2007

Name: _____ Index No: _____ Class: P5__

Section A	50	
Section B	40	
Out of 90 marks	Class	Level
Highest score		
Average score		
Parent's signature		

26th Oct 2007

SCIENCE

Att: 1 h 45 min

SECTION A (30 X 2 marks)

For each of the question from 1 to 30, four options are given. One of them is the correct answer. Make your choice (1, 2, 3 or 4). Shade the correct oval (1, 2, 3 or 4) on the Optical Answer Sheet (OAS) provided.

1. From 15th August to 29th August, Adeline observed and recorded the phases of the moon on a chart.

However, part of the chart was torn by her dog and the remainder of it is as shown below.

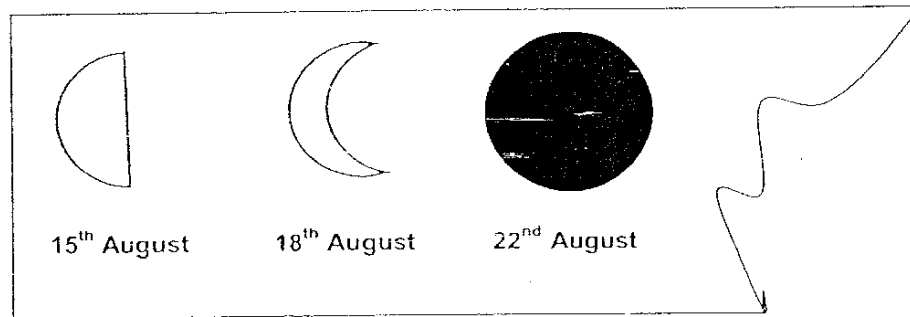

Which one of the following shapes of the moon was most likely observed by Adeline on 29th August?

(1) 	(2)
(3) 	(4)

sf

2. The diagram below shows Vivian's family tree.

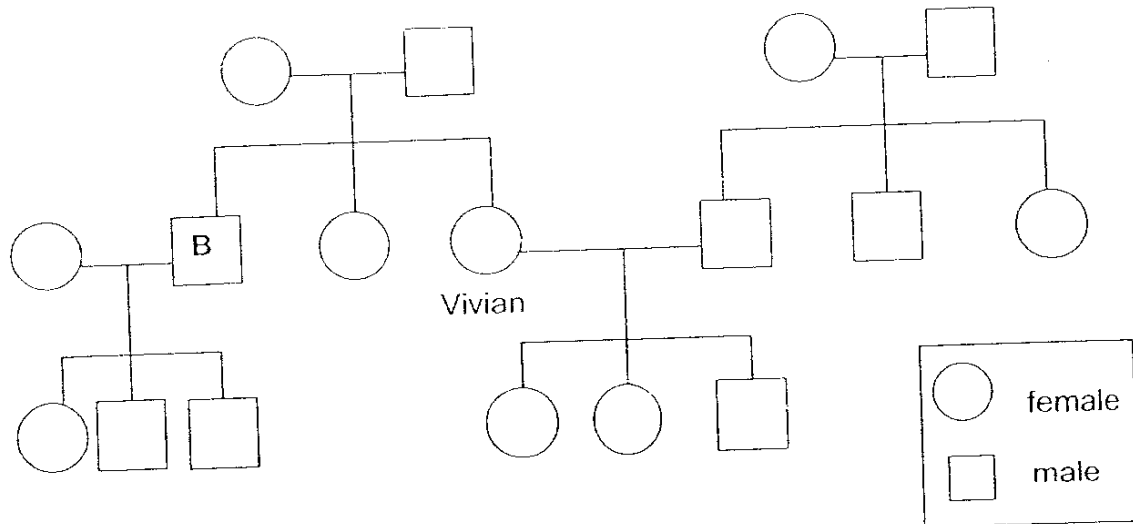

Based on the information above, how is B related to Vivian?

- (1) her sister
- (2) her uncle
- (3) her brother
- (4) her husband

3. The two cells shown below are examined under a microscope.

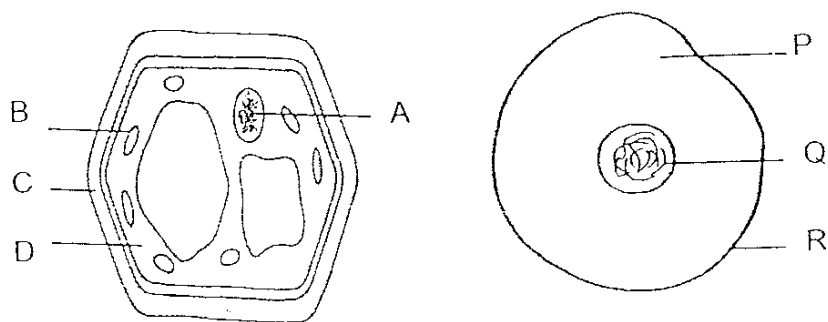

If the two cells above divide and produce daughter cells that have different characteristics from their parent cells, then the parts _____ would have been modified.

- (1) A and Q
- (2) B and R
- (3) C and P
- (4) D and S

4. Bees and butterflies are agents of pollination.
Butterflies have good vision but a poor sense of smell.
Bees, on the other hand, have a good sense of smell. However, bees are able to see the colours, blue, yellow and ultraviolet, but **NOT** red.

Jason found three different plants, X, Y and Z, in the garden and made the following observations:

Plant	Observations
X	Flowers are bright red. Many bees are seen flying around the plant.
Y	Flowers have huge, red petals. Many butterflies are seen fluttering around the plant.
Z	Both bees and butterflies are found around the plant.

Based on the observations above, what can Jason conclude about plants X, Y and Z?

- A Flowers on plant X have a sweet-smelling scent.
 - B Flowers on plant Y have a sweet-smelling scent.
 - C Flowers on plant Z are red and odourless.
 - D Flowers on plant Y might be odourless.
- (1) A and D only
(2) B and C only
(3) A, C and D only
(4) B, C and D only

5. The chart below distinguishes some fruits, A, B, C and D.

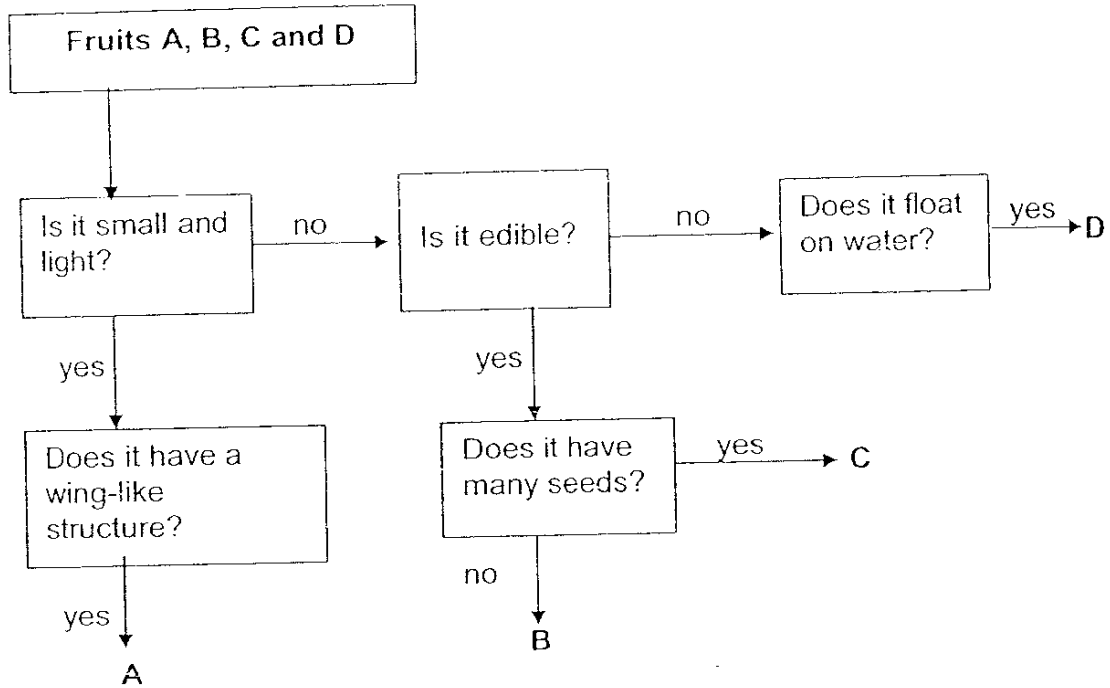

Based on the information above, which one of the following best represents fruits A, B, C and D?

	Fruit A	Fruit B	Fruit C	Fruit D
(1)	angsana	papaya	balsam	coconut
(2)	lalang	watermelon	mango	pong pong
(3)	shorea	kiwi fruit	rambutan	nipah
(4)	lovegrass	grape	peach	mangrove

6. Victor conducted an experiment using the apparatus as shown below.

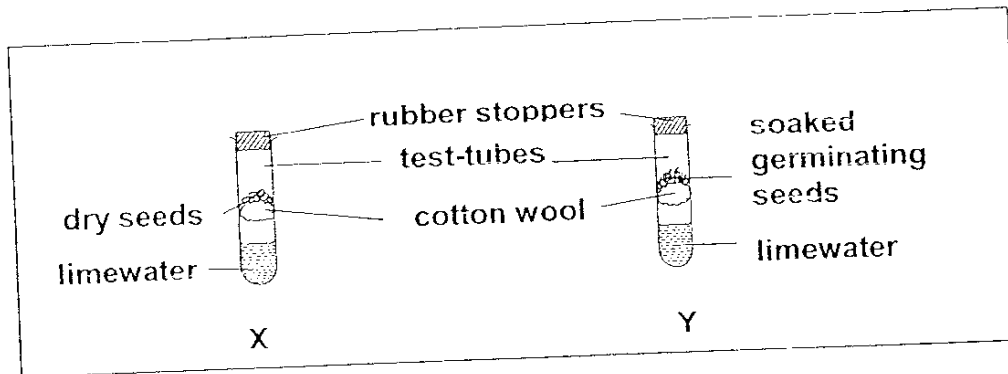

Victor placed the test-tubes, X and Y, near an open window. A week later, he noticed that the limewater had turned chalky in Y.

Victor made the following conclusions:

- A Oxygen had turned the limewater chalky.
- B Seeds need water and warmth to germinate.
- C During respiration, the germinating seeds give out carbon dioxide.

Which of Victor's conclusions are **CORRECT**?

- (1) A and B only
- (2) A and C only
- (3) B and C only
- (4) A, B and C

7. Kumar classified some organisms into 2 groups, X and Y, as shown below.

Group X	Group Y
sealing wax plant	tomato
bracket fungus	chilli
mould	chicken
heliconia	frog

Which one of the following pairs shows the organisms which **CAN** be put in Group X and Group Y?

- (1)

Group X	Group Y
penguin	dolphin
- (2)

Group X	Group Y
bird's nest fern	rambutan
- (3)

Group X	Group Y
coconut	shorea
- (4)

Group X	Group Y
pong pong	mango

58

8. The diagram below shows parts of the female human's reproductive system.

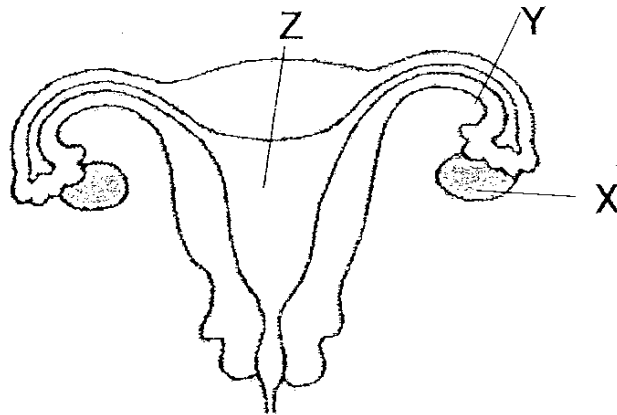

Which one of the following statements is **TRUE** of the system shown above?

- (1) The egg travels from Y to X.
 - (2) A fertilised egg is released from X every month.
 - (3) The sperm fuses with the egg at X during fertilisation.
 - (4) Cell division takes place in Z after the sperm fuses with the egg.
9. Rina's pencil box makes use of two pieces of magnets with parts A and B to close itself.

When Rina places a magnet with its North pole near part A (the black-coloured part) of the flap of her pencil box, the flap moves away.

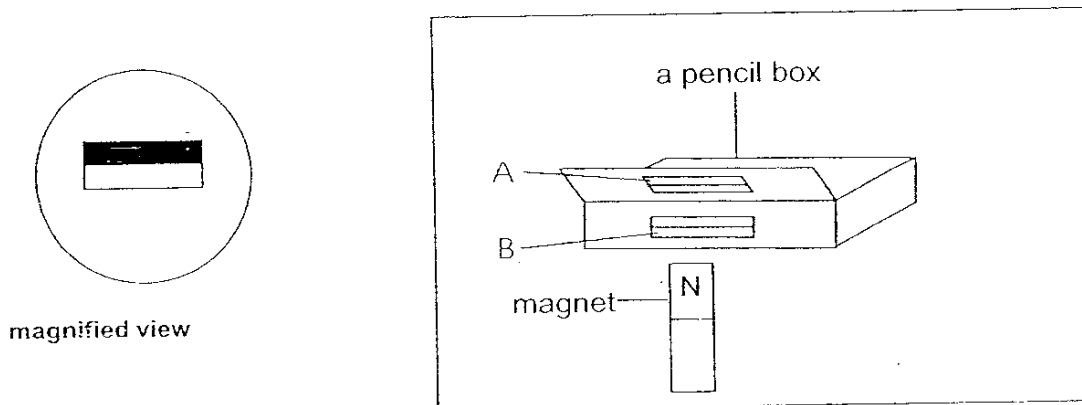

What are the poles of parts A and B?

- | | A | B |
|-----|-------|-------|
| (1) | North | North |
| (2) | South | South |
| (3) | North | South |
| (4) | South | North |

10. When a rock is exposed to wind and rain, it breaks down and drops to the ground. The cross-section of a cliff below shows the erosion that has taken place, exposing different layers of rock.

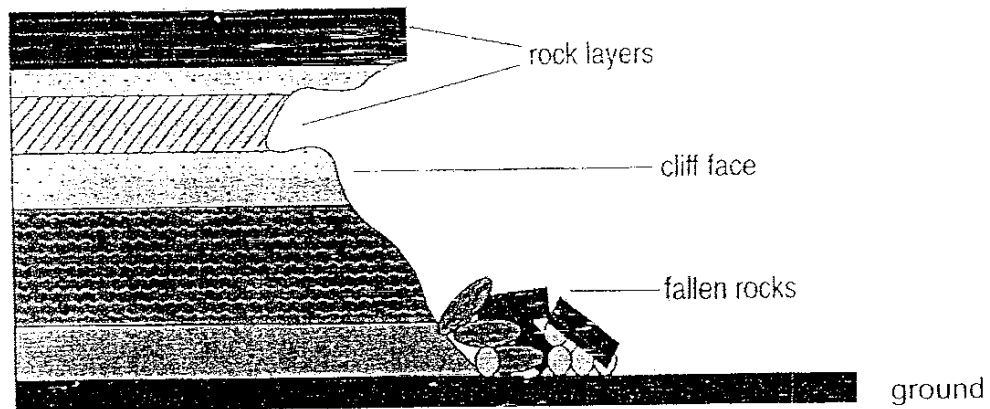

The above situation shows the effects of forces on an object.

Which one of the following describes the effect of the force shown?

- (1) It moves a stationary rock.
- (2) It changes the speed of the rock.
- (3) It changes the shape of the rock.
- (4) It increases the hardness of the rock.

11. Simple machines, S and T, are distinguished using the chart below.

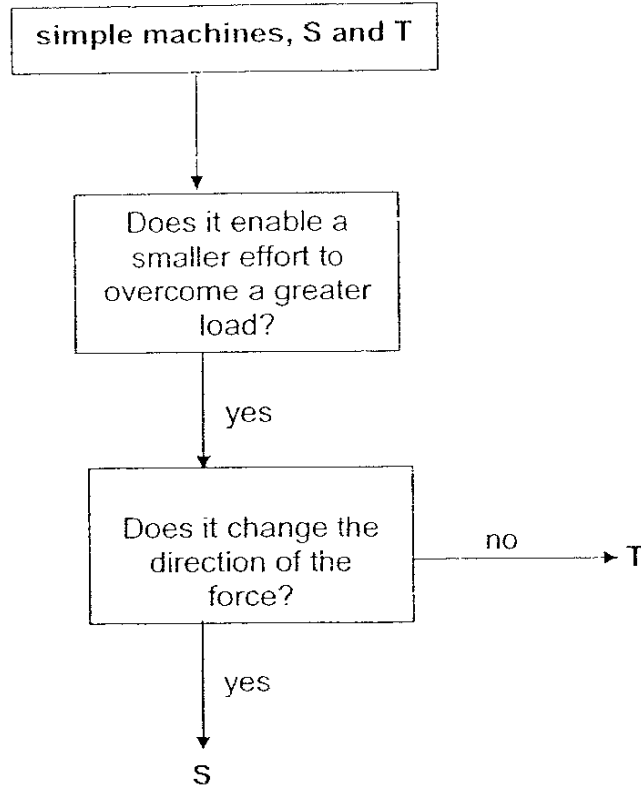

Based on the information above, which one of the following pairs shows what S and T are?

	Group S	Group T
(1)	bottle cap opener	cross spanner
(2)	scissors	fishing rod
(3)	fixed pulley	screw driver
(4)	claw hammer	movable pulley

12. The diagrams below show how a lever can be used.

The arrows represent the SIZE and DIRECTION of the forces.

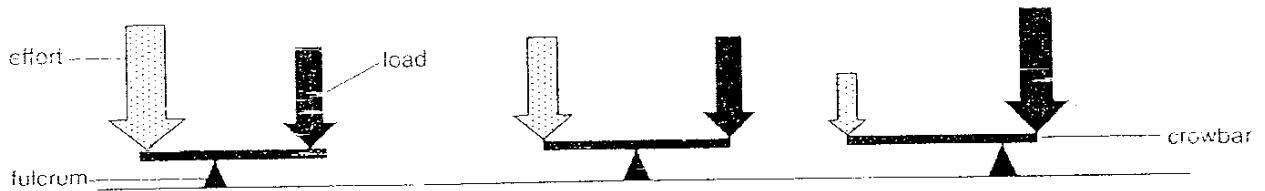

Based on all the diagrams above, we can conclude that as the distance between the load and fulcrum increases, the effort required to lift the load

- (1) increases
- (2) decreases
- (3) remains the same
- (4) moves in the opposite direction

13. Lily left some cooked rice in a conical flask, as shown below, for 6 days.

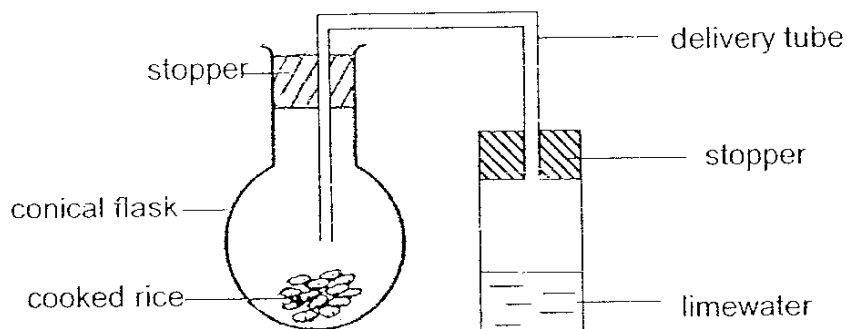

At the end of the 6th day, Lily noticed that the limewater in the test tube had changed from colourless to chalky.

Which one of the following graphs best represents the amount of carbon dioxide in the conical flask over the period of 6 days?

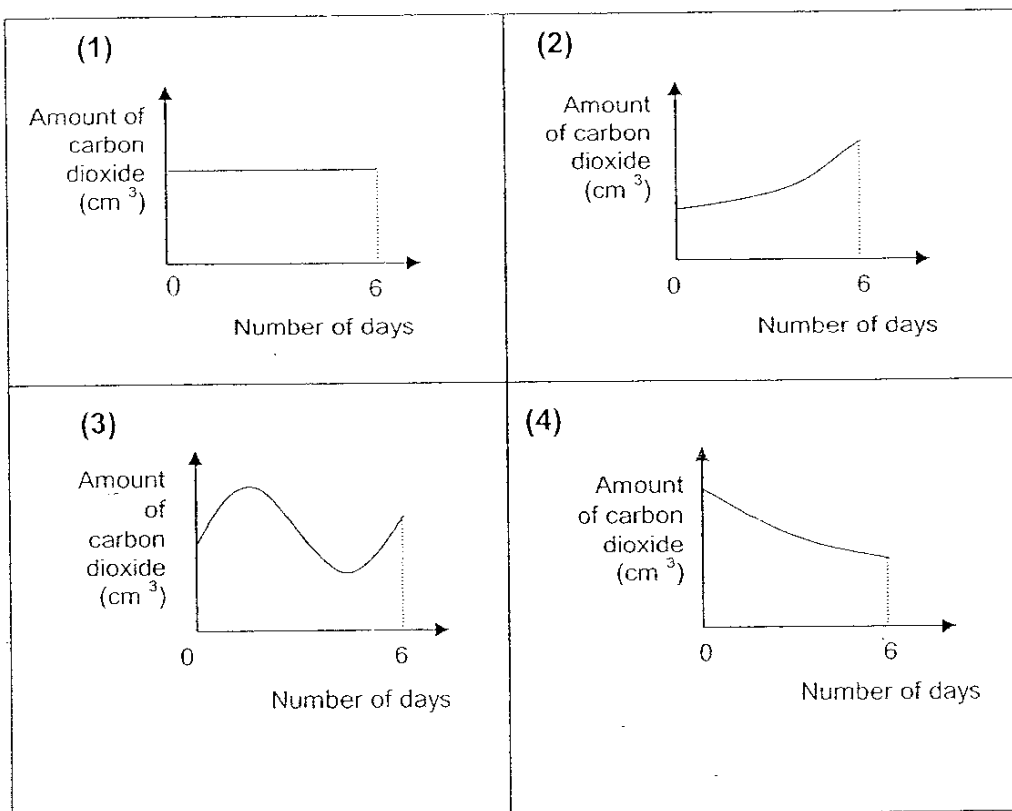

14. Which of the following statements about the circulatory system in humans are **TRUE**?

- A Blood flows in a single direction in the arteries.
- B Blood rich in carbon dioxide is returned to the heart before it reaches the lungs.
- C Contraction of the muscles around the vessels does not help to move blood around the body.
- D Digested food, carbon dioxide and water pass through the walls of the veins into the cells of the body.

- (1) A and B only
- (2) C and D only
- (3) A, B and D only
- (4) B, C and D only

15. Which one of the following statements about the skeleton of a human body is **FALSE**?

- (1) The skeleton protects some of our organs.
- (2) The skeleton supports the body and gives it its shape.
- (3) The skeletal system is made up of bones, joints and muscles.
- (4) The skeletal and muscular systems work together to help us move.

16. Cindy placed a metal spoon on an ice cube as shown below.

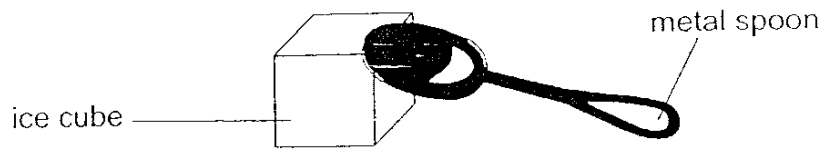

After 3 minutes, Cindy recorded her observations:

Observation 1	The ice cube becomes smaller.
Observation 2	The handle of the metal spoon is cold.

Which one of the following pairs of senses did Cindy use to make her observations?

Sense(s) Cindy used for	
Observation 1	Observation 2
(1) sight	touch
(2) smell	hearing
(3) taste	sight
(4) touch	smell

17. The diagram below shows how muscles, A and B, and bones work together to move our forearm.

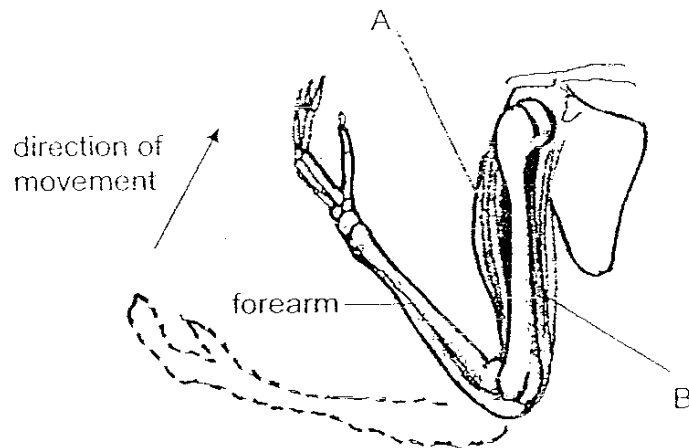

Which one of the following statements describes correctly what happens to the muscles when we move up our forearm?

- (1) Both A and B relax.
- (2) Both A and B contract.
- (3) A relaxes but B contracts.
- (4) A contracts but B relaxes.

18. The diagram below shows how the leaf of a plant carries out photosynthesis.

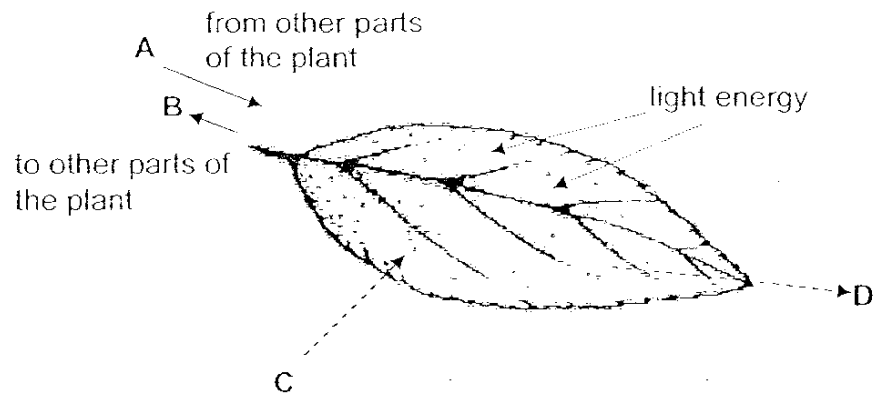

The arrows indicate the movement of various substances moving into and out of the leaf.

What do the arrows, A, B, C and D, represent?

	A	B	C	D
(1)	glucose	carbon dioxide	water	oxygen
(2)	carbon dioxide	oxygen	glucose	water
(3)	water	glucose	carbon dioxide	oxygen
(4)	glucose	water	oxygen	carbon dioxide

19. Some organisms, W, X, Y and Z, are found in a community. The information about these organisms is shown below:

- | |
|---|
| <ul style="list-style-type: none"> • X is eaten by W • W feeds on Y • Z feeds on Y but not X • Y gets its food from X |
|---|

Which one of the following is the correct classification of the organisms, X, W, Y and Z?

	food producer	herbivore	carnivore	omnivore
(1)	Z	X	Y	W
(2)	X	W	Z	Y
(3)	Y	Z	W	X
(4)	X	Y	Z	W

20. The diagram below shows a leaf, with patches of green and purple on the leaf surface, on a plant at the start of an experiment.

The areas, A, B, C and D, were tested for starch. All these areas were found to contain starch.

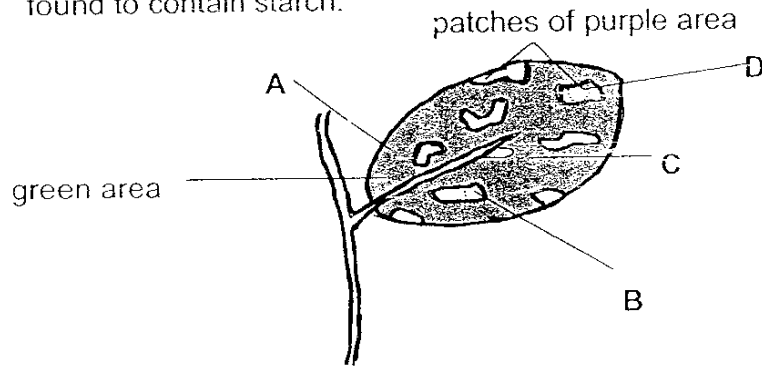

ANOTHER leaf, with similar patches of green and purple on the leaf surface, from the **SAME** plant was partly covered by black papers, as shown below.

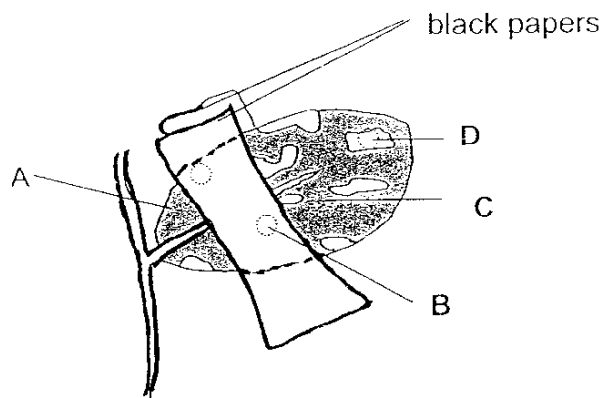

The plant was in the sun for 2 days. After 2 days, the leaf with the black papers was plucked off from the plant. The black papers were removed. This leaf was tested for starch.

Which of these areas, A, B, C or D, was starch found?

- (1) A and C only
- (2) B and D only
- (3) A, C and D only
- (4) B, C and D only

21. Susan set up the circuits, P, Q and R, as shown below, using the **SAME** components and objects of different materials, X, Y and Z, in each circuit.

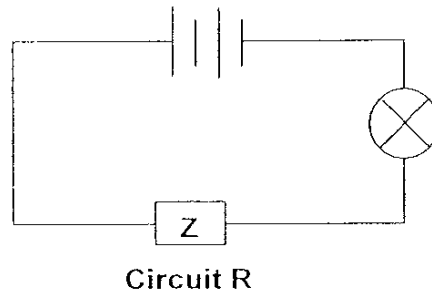
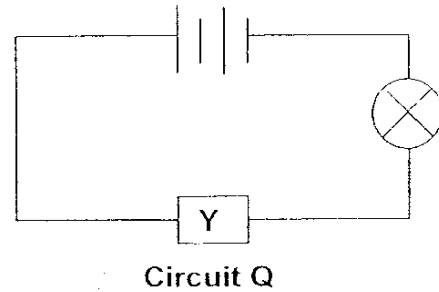
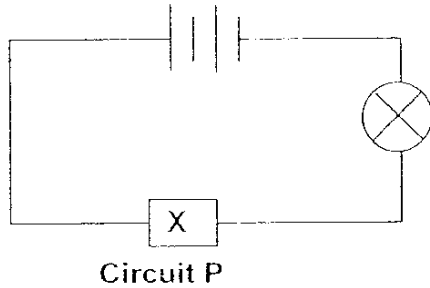

Susan made the following observations:

- The bulb in circuit R did **NOT** light up.
- The bulbs in circuits P and Q lighted up.
- The bulb in circuit Q was brighter than the bulb in circuit P.

What can Susan conclude about the materials, X, Y and Z, from her experiment?

- A Z is made of metal.
- B Z is a non-conductor of electricity.
- C X is a better conductor of electricity than Y.
- D Both X and Y are good conductors of electricity.

- (1) A and C only
- (2) B and D only
- (3) C and D only
- (4) B, C and D only

22. Francis set up an electric circuit as shown below.

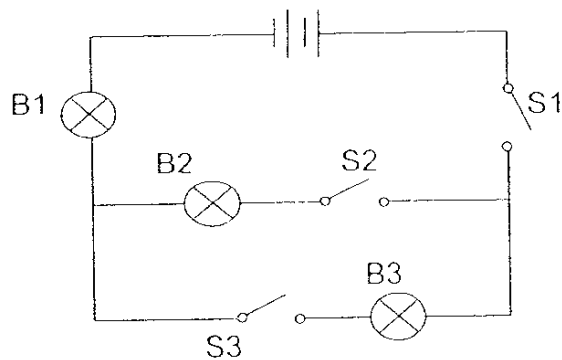

Which of the following bulbs would light up if Francis switched off S3 but switched on S1 and S2?

- (1) B2 only
 - (2) B3 only
 - (3) B1 and B2 only
 - (4) B2 and B3 only
23. Which one of the following statements about the Sun is **FALSE**?
- (1) Heat energy from the Sun keeps living things warm.
 - (2) The plants use light energy from the Sun to carry out photosynthesis.
 - (3) The Sun's energy is passed to the animals through the plants with chlorophyll.
 - (4) Light energy from the Sun ensures that the water cycle continues to take place.

24. Two cones made of an opaque material are stuck together at their bases to form the new figure shown below.

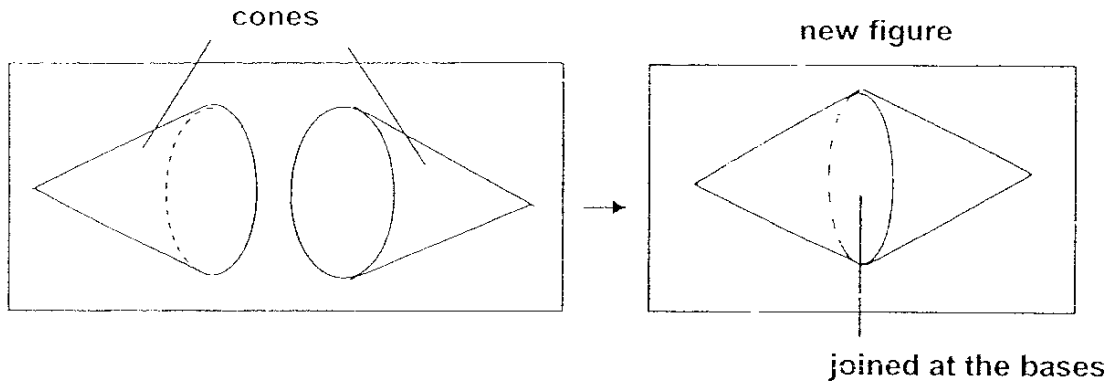

Light is shone at different angles on the new figure.

Based on the information above, which of the following shadows can be formed by the new figure?

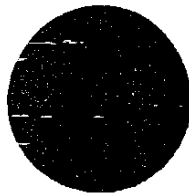

A

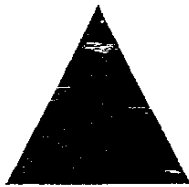

B



C

- (1) A and B only
 (2) A and C only
 (3) B and C only
 (4) A, B and C
25. Kelly put her left hand in a basin of water for 30 seconds. She then removed her hand and placed it under a running tap. Her hand felt cold.

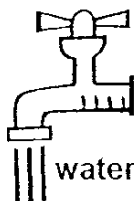

water at 30°C

What was the temperature of the water in the basin which Kelly had put her hand in earlier?

- (1) 5°C (2) 15°C
 (3) 25°C (4) 40°C

Name : _____ Index No : _____ Class : P5 _____

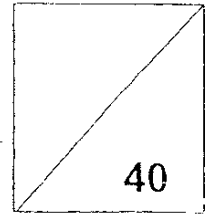

SECTION B (40 marks)

For questions 26 to 41, write your answers clearly in the spaces provided.

The number of marks available is shown in the brackets [] at the end of each question or part question.

26. The graph below gives information of some planets in the solar system.

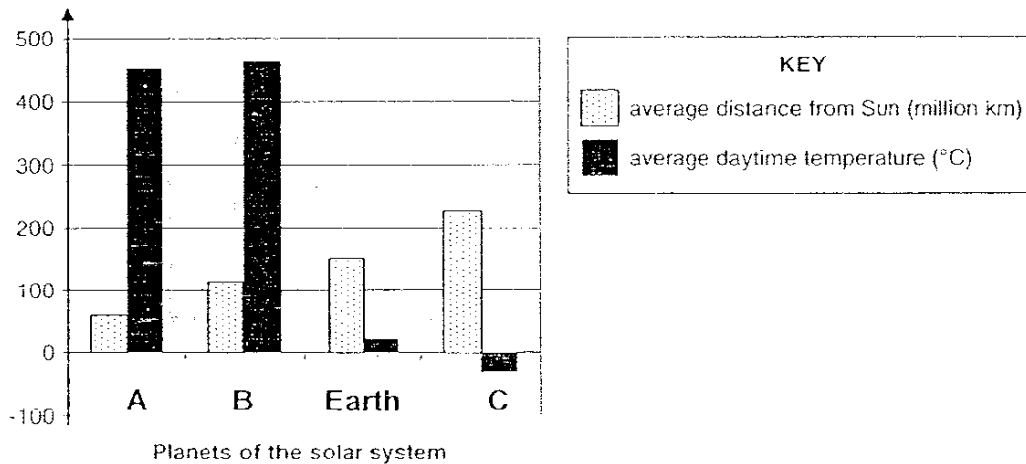

Based on the graph above, answer the following questions:

(a) What is the pattern between the average distance of the planet from the Sun and the average daytime temperature of the planet? [1]

(b) One planet, A, B or C, does **NOT** follow the pattern which is mentioned in (a). Name this planet. Write its letter, A, B or C, only. [1]

(c) Living things thrive on planet Earth as it receives the right amount of heat from the Sun. List **ONE** other condition that ensures the survival of the living things found on Earth. [1]

27. The chart below shows how different organisms, P, Q, R and S, are reproduced.

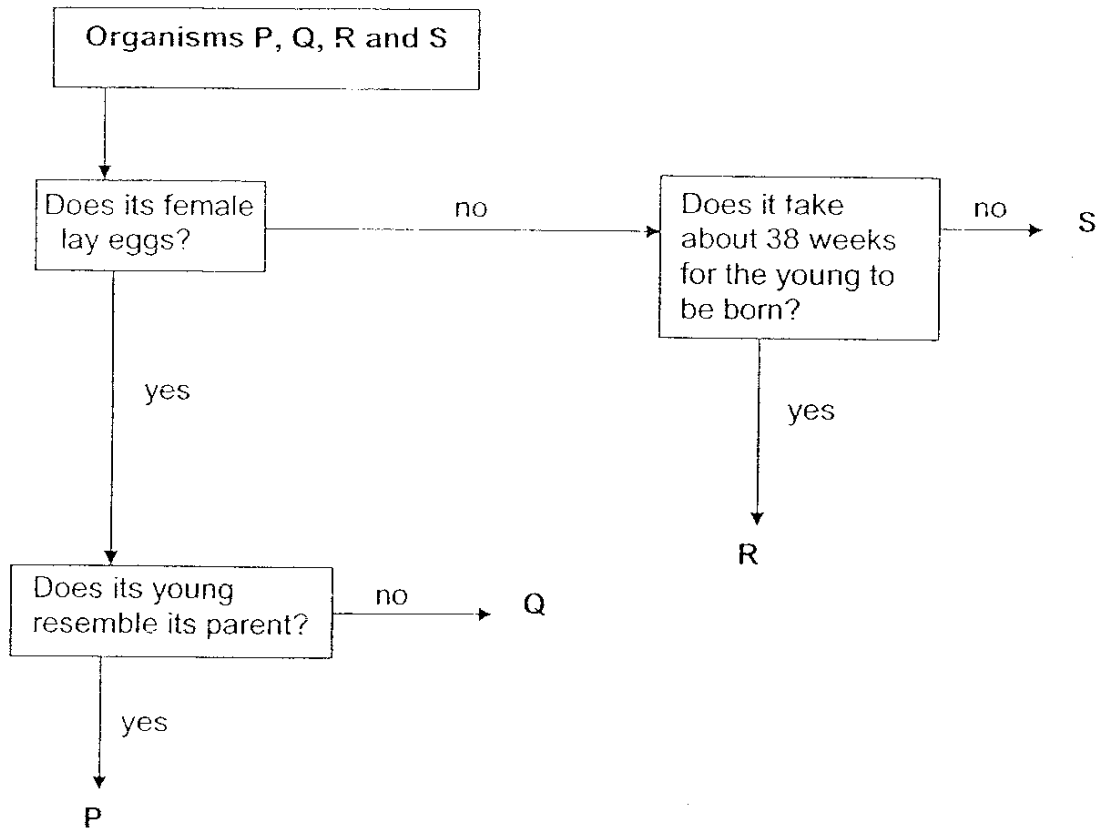

Based on the information above, answer the following questions:

- (a) Which organism best represents man?
Write letter, P, Q, R or S, only. [1]

- (b) State **ONE** similarity between P and Q. [1]

28. The chart below shows some characteristics of different animals.

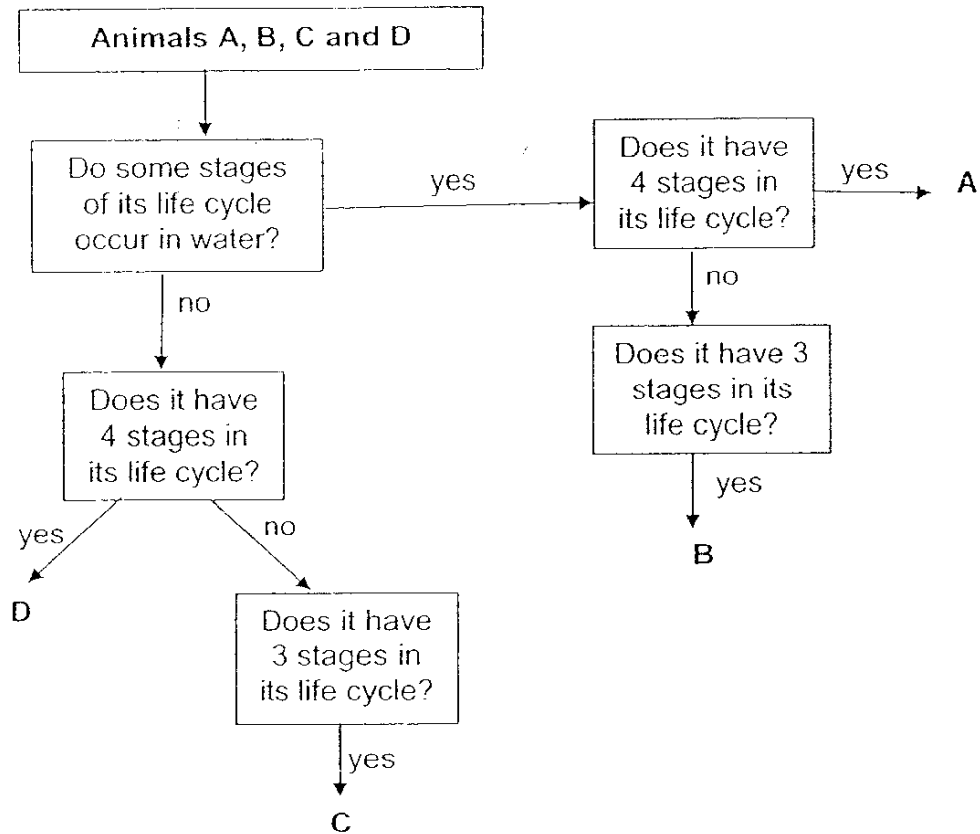

Based on the information above, answer the following questions:

- (a) What could the animals, A, B, C and D, be?
 Fill in the blanks using the animals listed below: [2]

frog	mealworm
mosquito	grasshopper

A	
B	
C	
D	

- (b) In the life cycle of a butterfly, **moulting** occurs during its _____ stage. [1]

29. The diagrams below show the cross-sections of the fruits of a papaya and a rambutan.

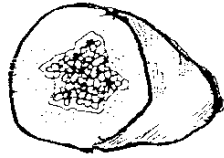

papaya

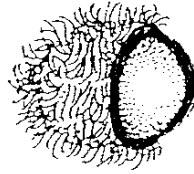

rambutan

- (a) Name **ONE** advantage of having small seeds like the papaya fruit. [1]

- (b) Give **ONE** common characteristic that both the papaya and the rambutan share in order that their seeds can be dispersed by the animals. [1]

30. The diagram below shows a plant that grows from its plant part.

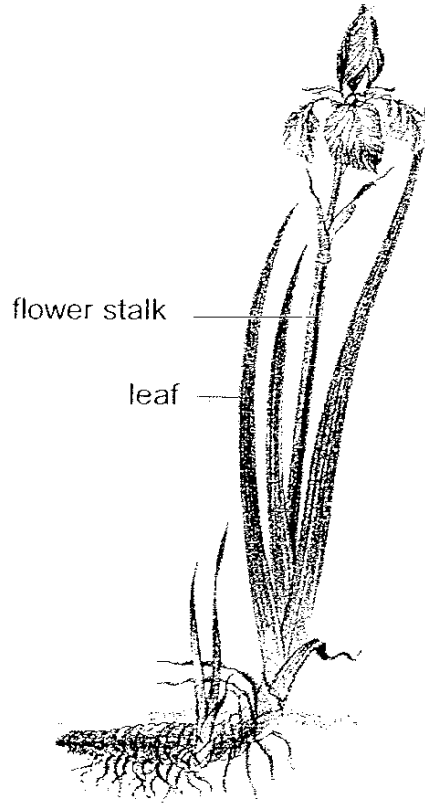

- (a) In the diagram, **MARK** with a cross, X, to show where its young is growing from. [1]
- (b) State **ONE** disadvantage of this type of reproduction. [1]

31. The diagrams below show a ginger and a paramecium.

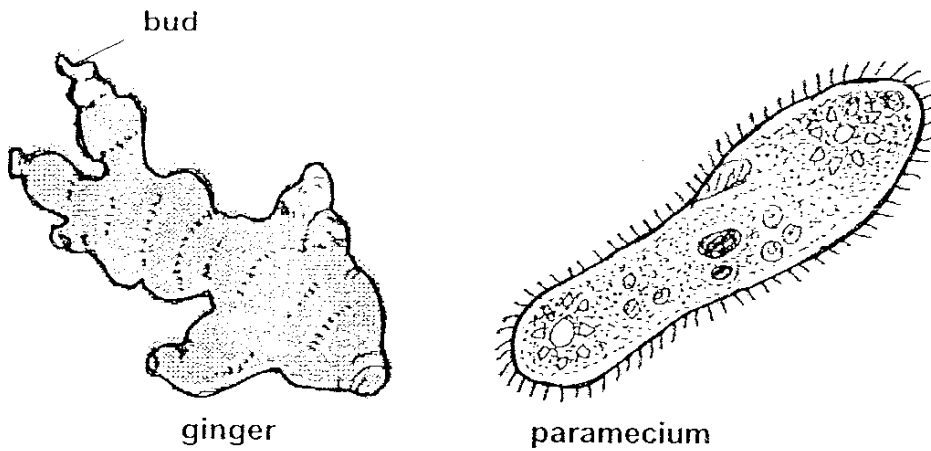

- (a) State **ONE** similarity in the method of reproduction between the ginger plant and the paramecium cell. [1]

- (b) Give **ANOTHER** example of a plant that reproduces the same way as the ginger. [1]

32. Jerry placed some paper clips on a thin sheet of plastic. He placed a strong magnet directly under the sheet of plastic.

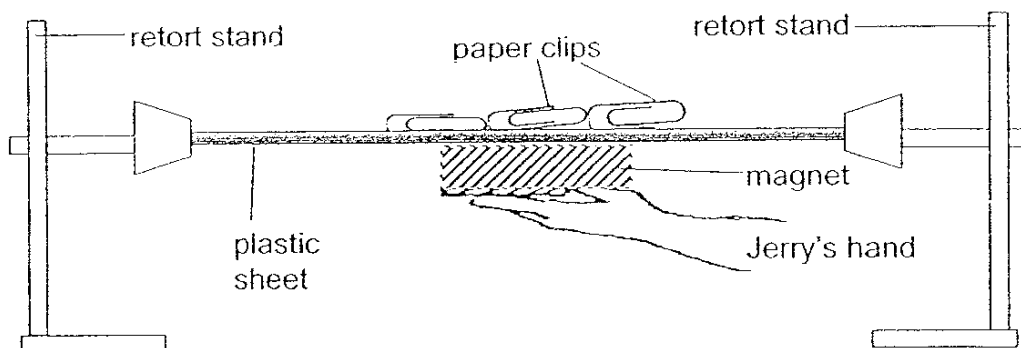

Based on the information above, answer the following questions:

- (a) What would Jerry observe of the paper clips when he moved the magnet to and fro under the plastic sheet? [1]

- (b) Explain Jerry's observation(s) of the paper clips. [1]

33. Tom pulled a 50-kg sack of rice up three ramps, A, B and C, of height as shown in the diagrams below.

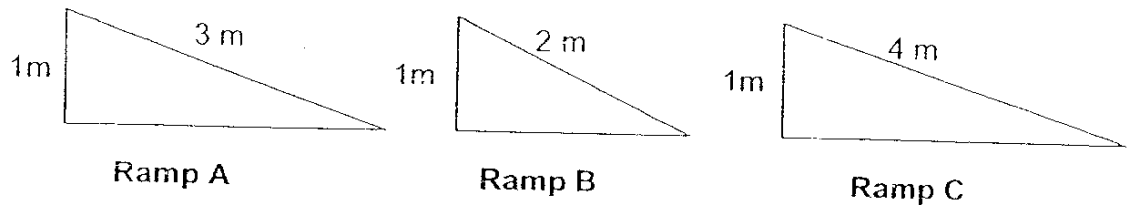

Tom measured the effort needed to pull the sack of rice up each ramp and recorded them in the table below.

Ramp	Effort needed (kg)
A	30
B	40
C	20

Based on the information above, answer the following questions:

- (a) What is the relationship between the length of the ramp and the effort Tom needed to pull the sack of rice up the ramp? [1]

- (b) State **ONE OTHER** variable that Tom needs to keep the same to ensure that he conducts a fair test. [1]

34. Kok Lam left a fish in a tank **WITHOUT** changing the water.

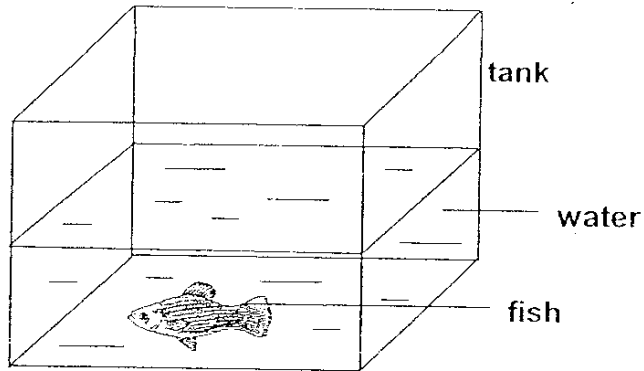

He observed the number of times the fish opened and closed its mouth in one minute for several days and plotted the following graph.

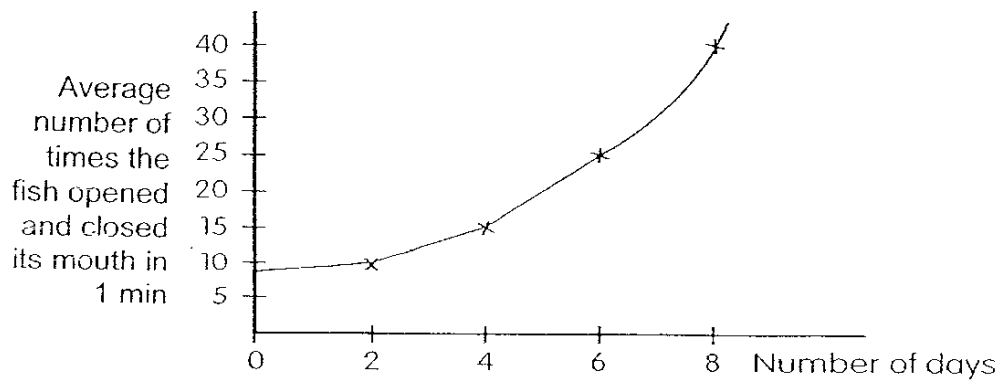

Based on the information above, answer the following questions:

- (a) What was the average number of times the fish opened and closed its mouth in one minute when it was in the tank on the 6th day?

[1]

- (b) What can Kok Lam conclude from the graph that he had plotted?

[1]

35. Ravi placed a plant in a beaker of tap water with some dark blue food colouring.

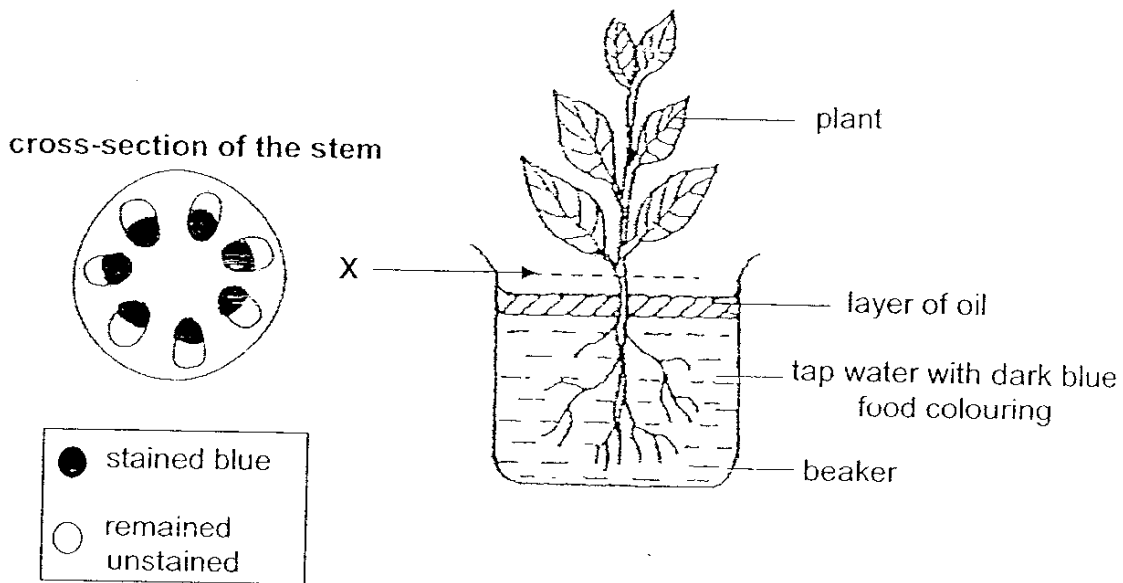

After 24 hours, Ravi cut the stem of the plant at point X. He noticed that some parts of the cross section of the stem had been stained blue.

Based on the information above, answer the following questions:

- (a) Name the parts of the stem which had been stained blue. [1]

- (b) State **ONE** function of the plant parts that were stained blue. [1]

36. The diagram below shows parts of the digestive system of a man.

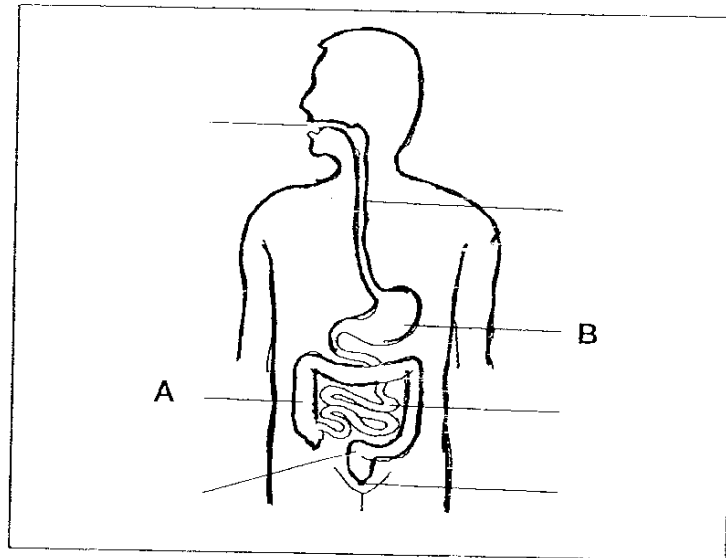

Based on the diagram above, answer the following questions:

(a) Name the organs, A and B. [1]

A: _____

B: _____

(b) **MARK** and **LABEL** on the diagram the part(s) of the system where the following processes take place: [2]

(i) X, where digestion **starts**

(ii) Y, where digestion **ends**

37. David set up an experiment using an aquatic plant and the apparatus as shown below.

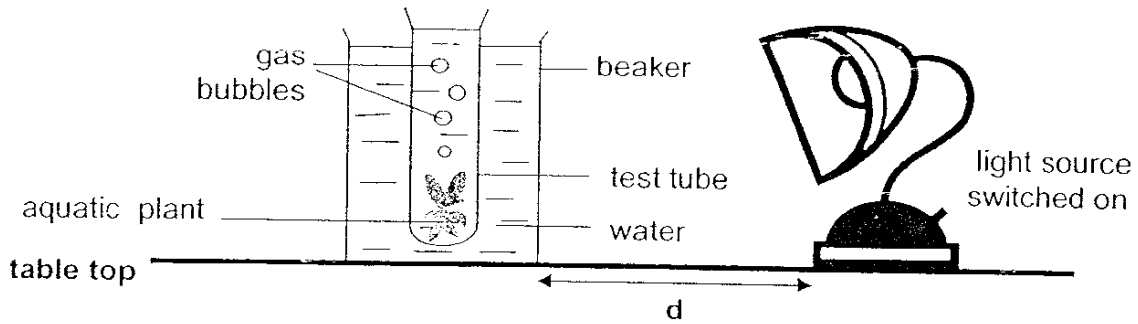

As David changed the distance of the light source from the beaker, d , he recorded the number of gas bubbles given out by the aquatic plant per minute.

He plotted a graph below based on his observations.

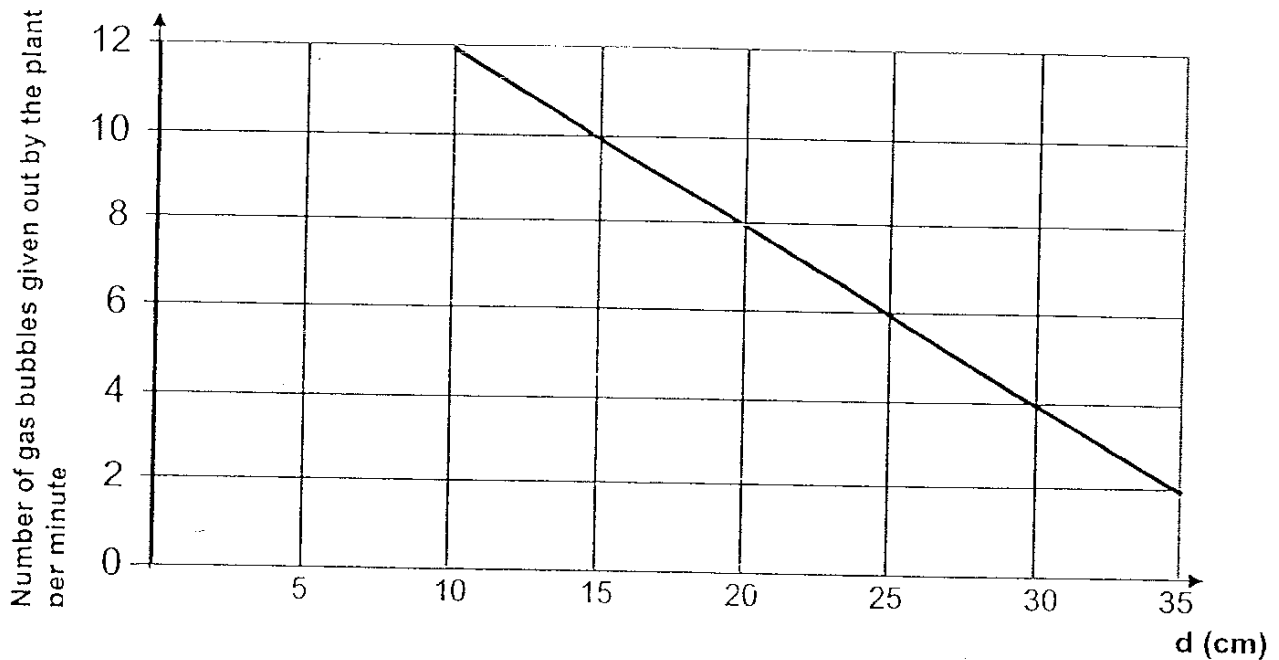

Based on the graph above, answer the following questions:

- (a) What is the number of gas bubbles given out by the aquatic plant per minute when the light source is 20 cm away from the beaker?

[1]

WITHOUT changing the apparatus, David covered the beaker all round with a piece of tracing paper.

Using the **SAME** distance of the light source from the beaker, d, David recorded the number of gas bubbles given out by the **SAME** aquatic plant per minute.

- (b) What could David observe from his set-up this time?
Explain your answer.

[2]

- (c) **DRAW** on the graph given on Page 30, the new result David would likely to observe in (b).

[1]

38. The diagram below shows the components of a circuit that are **NOT** connected.

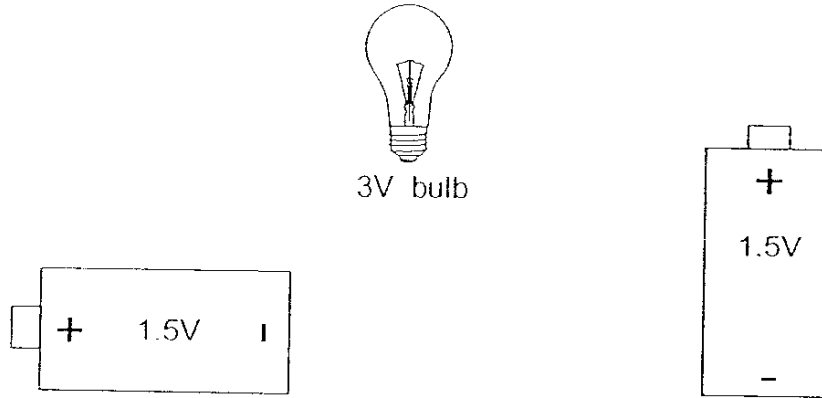

- (a) **DRAW** 3 wires in the diagram above to connect all the components to enable the bulb to light up. [2]

The diagram below shows four lighted bulbs, A, B, C and D, connected to the batteries. A switch is added such that when the switch is open, **ONLY ONE** bulb is **NOT** lighted up while the other three remain lighted at all times.

- (b) **MARK** with a cross, X, on the part of the circuit in the diagram below, to show where this switch is. [1]

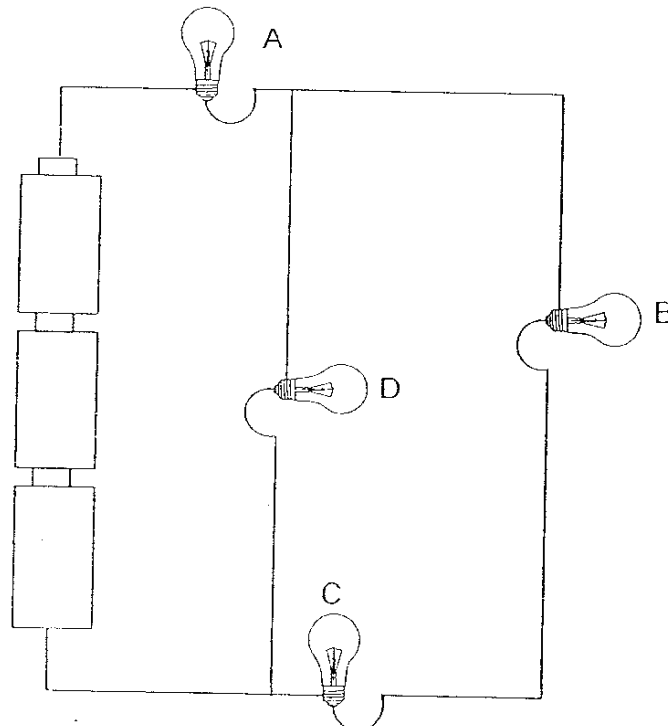

- (c) Which one of the bulbs, A, B, C or D, is controlled by the switch? [1]

Bulb _____

39. Brenda had three rods, X, Y and Z, of unknown materials. She placed them in various positions, A, B and C, in the circuit diagram shown below.

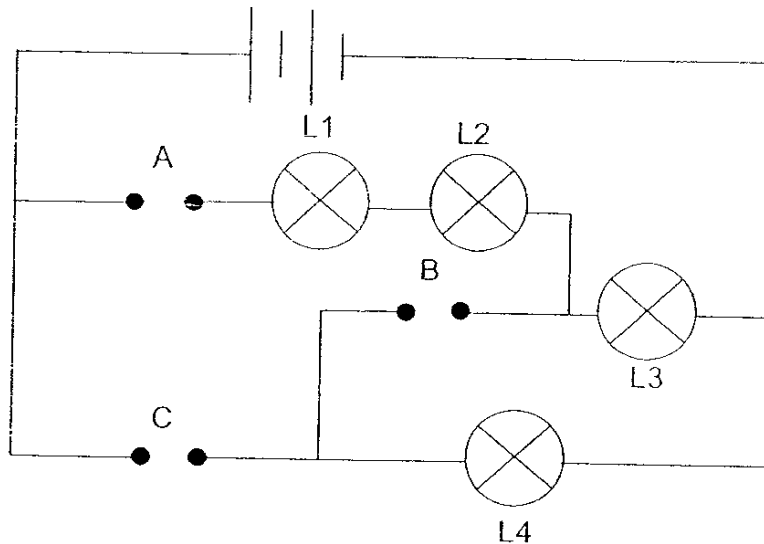

The results of Brenda's experiment were recorded in the table below. A tick (\checkmark) in the box shows that the lamp was lighted up.

Positions at which the rods were placed			lamps			
A	B	C	L1	L2	L3	L4
X	Y	Z				\checkmark

- (a) Using the information above, which lamp(s) lighted up when the rods were placed at the different positions indicated in the table below? [3]

Put a tick (\checkmark) in the correct boxes to show the lamp(s) which was/were lighted up.

Positions at which the rods were placed			lamps			
A	B	C	L1	L2	L3	L4
X	Z	Y				
Z	Y	X				
Y	X	Z				

40. The diagram below shows that an opaque object is placed between a pin light source and a white screen.

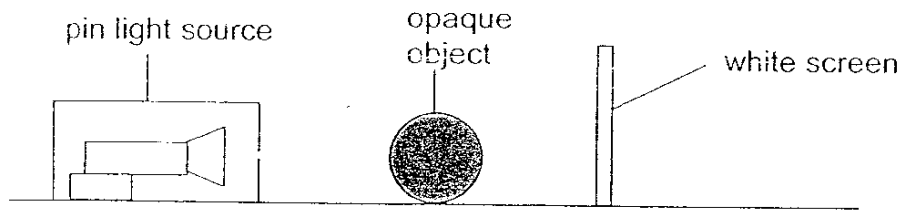

- (a) Using the **SAME** object, suggest **ONE** way to increase the size of its shadow **WITHOUT** moving the screen. [1]

- (b) Choose the correct outline of the shadow formed on the white screen from one of the boxes below.

Then **SHADE** correctly the shadow that is seen on the white screen. [1]

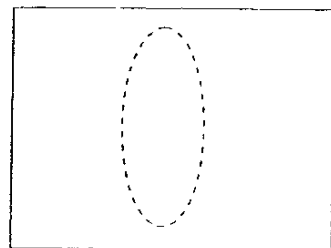
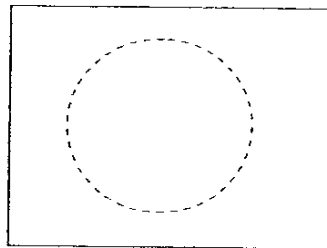
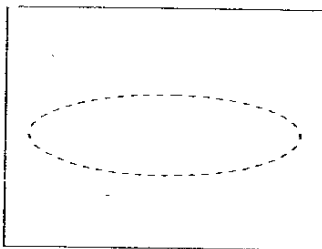

41. Jane took an aluminium block which was connected to an electrical supply. She inserted a thermometer into the block as shown below.

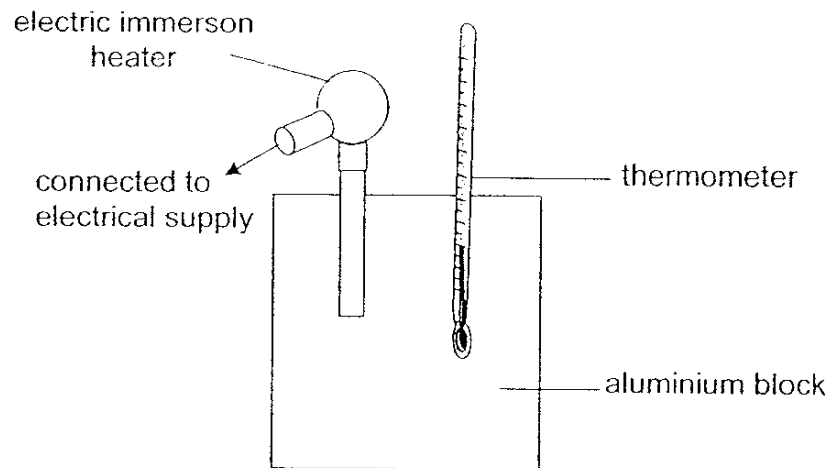

When an electric current was passed through the aluminium block for a while, what would Jane notice of the alcohol level in the thermometer?

Explain your answer.

[2]

- END OF PAPER -

Setters : Mrs Lily Ng
Mrs Christina Lim
Mdm Ho Sheen Yee
Ms Pek Xue Yan
Ms Lim Siew Hoon

Raffles Girls' Primary School

Primary 5 Science SA2 Exams (2007)

Answer Keys

SECTION A : (60 MARKS)

Qn no.	Ans
1	3
2	3
3	1
4	1
5	3
6	3
7	2
8	4
9	3
10	3

Qn no.	Ans
11	4
12	1
13	2
14	1
15	3
16	1
17	4
18	3
19	4
20	3

Qn no.	Ans
21	2
22	3
23	4
24	2
25	4

SECTION B (40 MARKS)

- 26a. The further the average distance of the planet from the sun, the lower is the average daytime temperature of the planet.
- 26b. B
- 26c. On earth, there is water, one of the necessities for the survival of living things. On other planets, the water will either evaporates or freeze.
- 27a. R
- 27b. For both of the organisms, the female lays eggs.
- 28a. A : mosquito B : frog
C : grasshopper D : mealworm
- 28b. larval
- 29a. There are many seeds in one fruit making its chance of reproducing bigger
- 29b. They are edible.

30a.

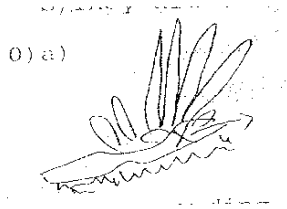

30b. Overcrowding might occur so the young plant not gets enough water, mineral salts, oxygen, carbon dioxide and sunlight to live.

31a. Both reproduce a sexually.

31b. Water chestnut.

32a. The paper clips will follow the magnet and go wherever the magnet goes.

32b. The magnet exerts a magnetic force on the paper clips, causing them to move.

33a. The longer the ramp, the less the effort needed to pull the sack of rice up.

33b. He must sure that the material which is used to make the ramp is the same.

34a. 25

34b. Less oxygen is in the water day by day. So the fish has to open and close its mouth more after to get surface oxygen for its survival.

35a. xylem tubes

35b. They carry water and mineral salts from the roots to the other parts of the plant.

36a. A : large intestine

B : stomach

36b.

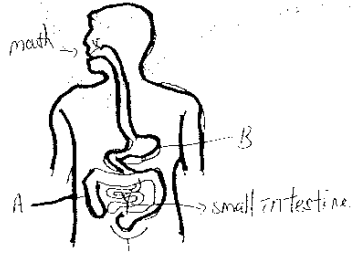

- 37a. The number of gas bubbles given out by the aquatic plant is 8.
 37b. Fewer bubbles were produced. The tracing paper is translucent. It blocks some light from reaching the aquatic plant. Hence, fewer bubbles will be produced from the aquatic plants.

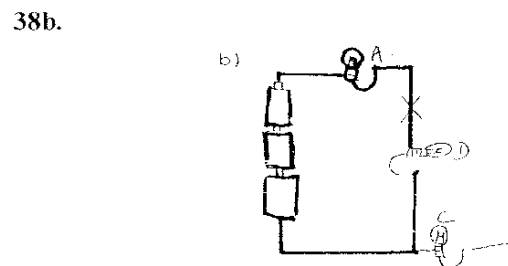
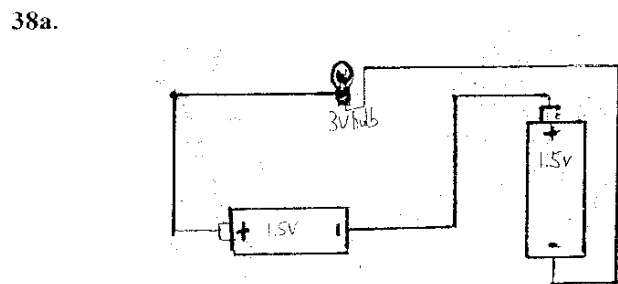
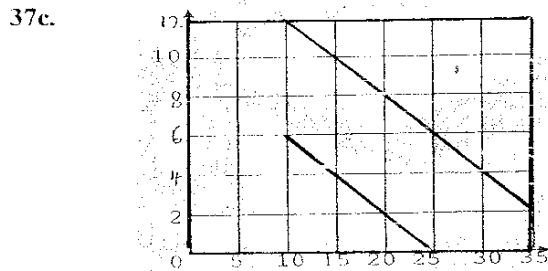

39. ZYX = ✓✓✓
 YXZ = ✓

40a. Move the object towards the pin light source.



41. The alcohol level in the thermometer rose until it finally stopped. The heat from the aluminum block travels to the bulb of the thermometer and cause the alcohol to gain heat and rise up the tube.