

17

Anglo-Chinese School (Junior)



CONTINUAL ASSESSMENT 2 (2016)
PRIMARY 5

SCIENCE

BOOKLET A

THURSDAY

25 AUGUST 2016

50 minutes

Name: _____ () Class:5.()

INSTRUCTIONS TO PUPILS

DO NOT TURN OVER THE PAGES UNTIL YOU ARE TOLD TO DO SO

Follow all instructions carefully.

There are 12 questions in this booklet.

Answer **ALL** questions.

INFORMATION FOR PUPILS

The total marks for this booklet is 24.

The total time for Booklets A and B is 50 minutes.

This question paper consists of 11 printed pages (inclusive of cover page).

Booklet A (24 marks)

For each question from 1 to 12, four options are given. One of them is the correct answer. Choose the correct option (1, 2, 3 or 4) and shade the correct oval on the Optical Answer Sheet (OAS).
(12 x 2 marks)

1 Study the flowchart below.

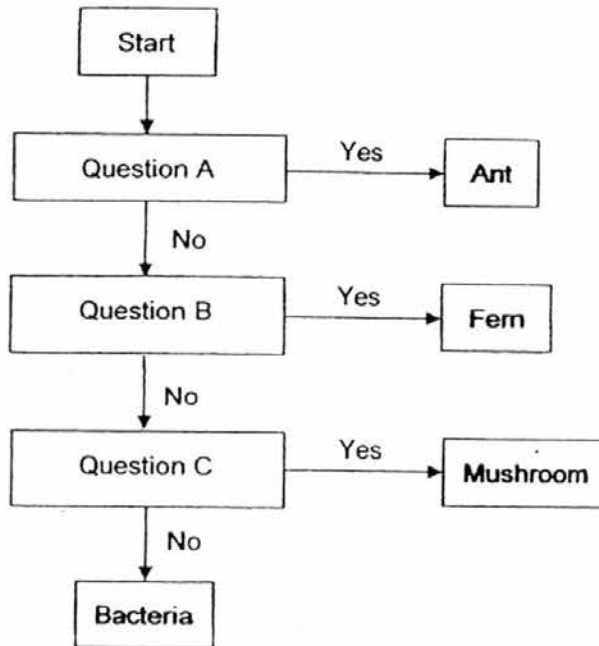

Which of the following can be Questions A, B, and C?

	Question A	Question B	Question C
(1)	Does it make its own food?	Can it be seen without the microscope?	a plant Is it an animal?
(2)	Is it an animal?	Does it make its own food?	Can it be seen without the microscope?
(3)	Does it make its own food?	Can it be seen without the microscope?	Is it an animal?
(4)	Can it be seen without the microscope?	Is it an animal?	Does it make its own food?

- 2 Tessa conducted an experiment to find out how moisture would affect the growth of bread mould. She took 3 identically-sized slices of fresh bread, A, B and C, and toasted A in an electric oven, moistened B with some drops of water, but left C untouched. She then placed each slice of bread into identical zip-lock plastic bags and sealed them as shown in the diagram below.

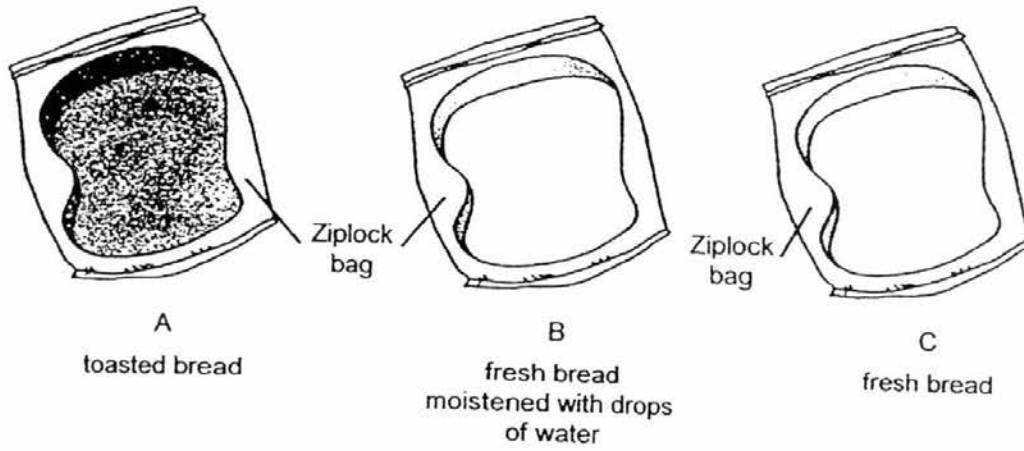

Tessa left the above set-ups in a dark kitchen cupboard for a week. Arrange the set-ups in order, beginning with the one with the least bread mould found at the end of the experiment.

	Least bread mould	Some bread mould	Most bread mould
(1)	A	B	C
(2)	B	C	A
(3)	C	B	A
(4)	A	C	B

- 3 The diagram below shows 5 magnets with their ends labelled. The magnets are arranged so that they are **attracted** to one another.

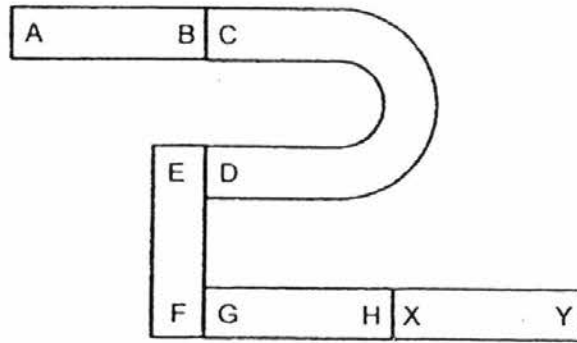

Based on the above diagram, which of the following arrangements of magnets is **not** possible?

<p>(1)</p>	<p>(2)</p>
<p>(3)</p>	<p>(4)</p>

- 4 The diagram below shows the human digestive system.

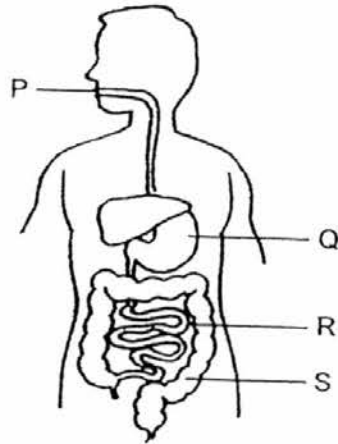

Which of the following correctly represents the functions of the parts P, Q, R and S?

	P	Q	R	S
(1)	Saliva mixes with food and starts the digestion process	Digestion is completed here	Digested food is absorbed and passes into the bloodstream	Water from undigested food is absorbed here
(2)	Food is chewed into smaller pieces	Digested food is absorbed and passes into the bloodstream	Water from undigested food is absorbed here	Undigested food is stored here before it is passed out of the body
(3)	Saliva mixes with food and starts the digestion process	Food is broken down into simpler substances	Digestion is completed here	Water from undigested food is absorbed here
(4)	Food is chewed into smaller pieces	Digested food is absorbed and passes into the bloodstream	Water from undigested food is absorbed here	Undigested food is passed out of the body

Digestion is completed here

- 5 The diagram below shows 3 set-ups, A, B, and C, using identical glass beakers which are each filled with 200 ml of water. The 3 set-ups are placed in a garden during the day for 8 hours.

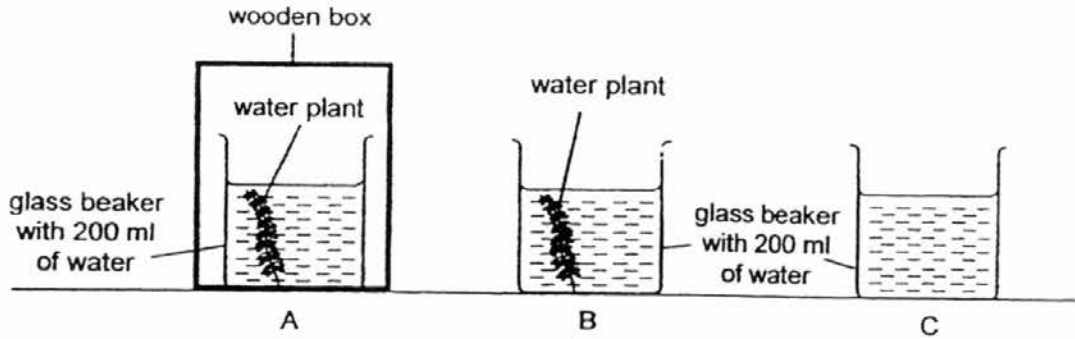

Predict the order of the set-ups according to the amount of dissolved carbon dioxide present in the water of the beakers at the end of the experiment, beginning with the one with the least amount of dissolved carbon dioxide present.

	Least Dissolved Carbon Dioxide	→	Most Dissolved Carbon Dioxide
(1)	A		B
(2)	B		C
(3)	B		A
(4)	C		B

- 6 The diagram below shows the human circulatory system. A, B, C and D represent blood vessels.

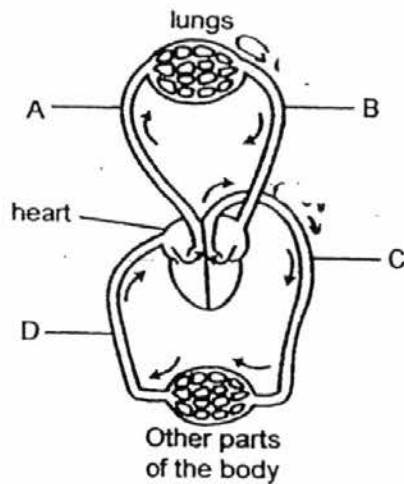

Which blood vessels contain the most amount of oxygen?

- (1) A and B only
- (2) B and C only
- (3) C and D only
- (4) A and D only

- 7 The diagrams below show some electrical circuits. Which 2 circuits will produce the brightest lit bulbs?

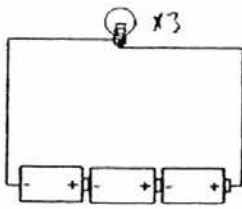

A

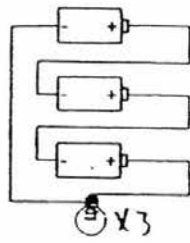

B

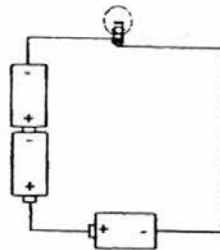

C

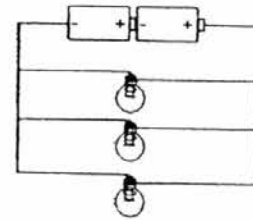

D

- (1) A and B only
- (2) B and C only
- (3) C and D only
- (4) A and D only

- 8 Ryan used a circuit tester to test a circuit card. He connected the points X and Y of the circuit tester to the various clips 1, 2, 3, 4, 5 and 6 on a circuit card to see if the bulb would light up. He recorded the results of his experiment in the table below.

Connection tested	Did the bulb light up?
1 and 4	Yes
2 and 4	Yes
3 and 5	No
5 and 6	No
1 and 6	No

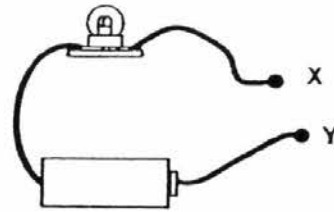

circuit tester

Which of the diagrams represents the circuit card that was tested?

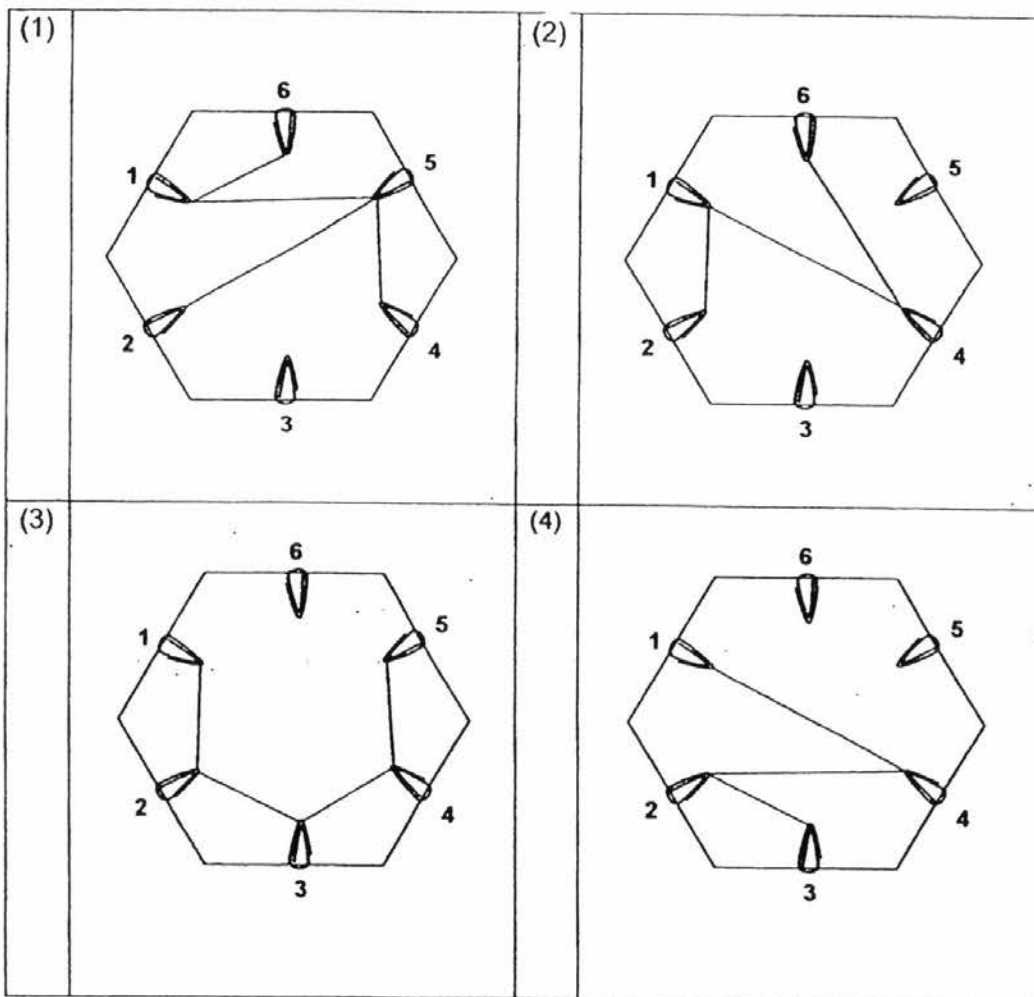

- 9 The diagram below shows a glass of hot tea with some ice cubes.

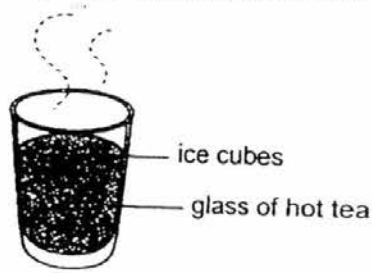

Which of the following statements are correct?

- A The ice cubes will lose heat to the hot tea.
- B The hot tea will lose heat to the ice cubes.
- C The temperature of the hot tea will increase.
- D The ice cubes will undergo a change of state.

- (1) A and B only
- (2) A and C only
- (3) B and D only
- (4) C and D only

- 10 Below is a concept map of process X.

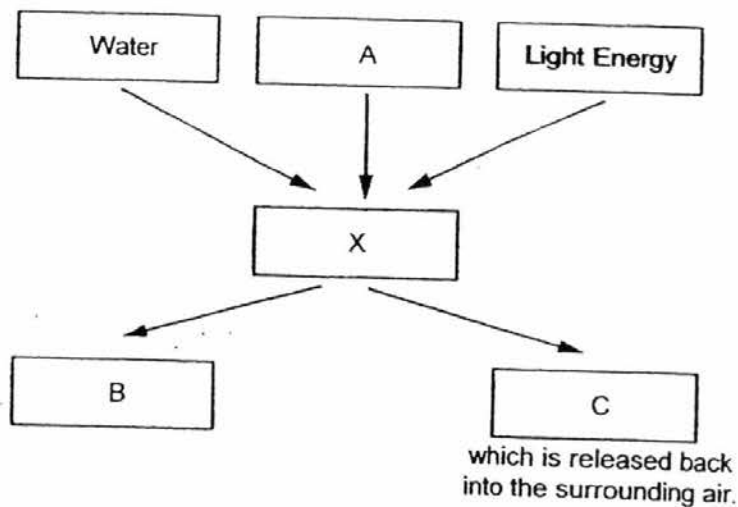

Which of the following correctly represents process X and substances A, B and C?

	X	A	B	C
(1)	Respiration	Oxygen	Glucose	Carbon Dioxide
(2)	Photosynthesis	Oxygen	Glucose	Carbon Dioxide
(3)	Respiration	Carbon Dioxide	Glucose	Oxygen
(4)	Photosynthesis	Carbon Dioxide	Glucose	Oxygen

- 11 Ryan carried out an experiment as shown in the diagram below.

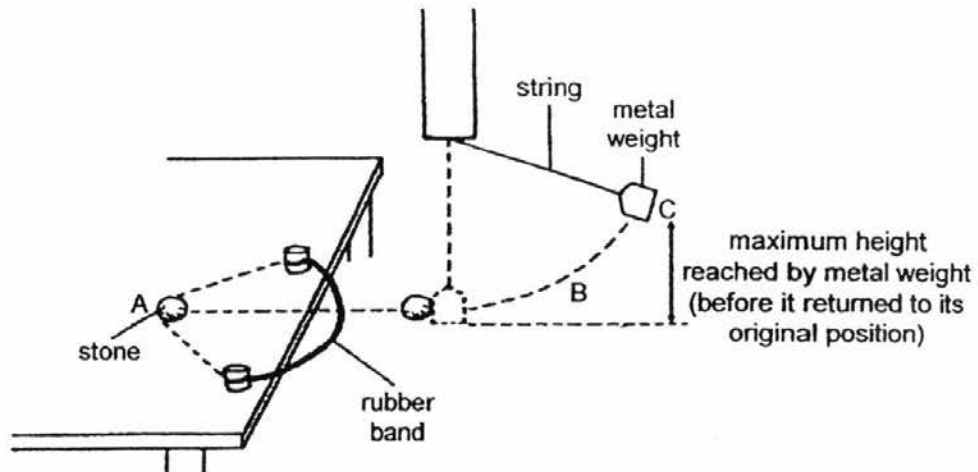

Ryan first pulled the rubber band together with the stone backwards to Point A. When he released the rubber band with the stone, the stone moved forward and flew off the table, striking the metal weight which was suspended on a string. The metal weight moved upwards through Point B and stopped moving when it reached its maximum height at Point C, before returning to its original position.

Which of the following shows the correct form(s) of energy at Points A, B and C?

	A	B	C
(1)	kinetic energy	gravitational potential energy	gravitational potential energy
(2)	kinetic energy	kinetic energy	kinetic and gravitational potential energy
(3)	elastic potential energy	kinetic and gravitational potential energy	gravitational potential energy
(4)	elastic potential energy	kinetic and gravitational potential energy	kinetic energy

- 12 The diagram below shows a glass marble in a curved container. When the marble is released at Point X, it moves down the ramp and up to Point Z before rolling back down.

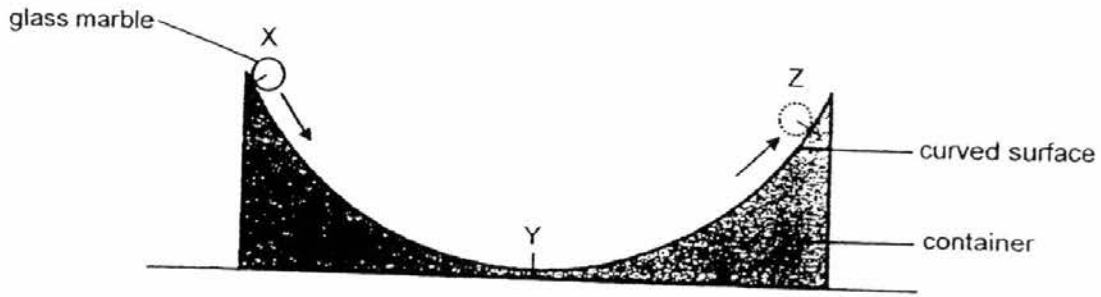

Which of the following graphs correctly shows the amounts of gravitational potential energy and kinetic energy of the glass marble as it moves from Point X to Point Z?

Key :

Gravitational potential energy _____

Kinetic energy _____

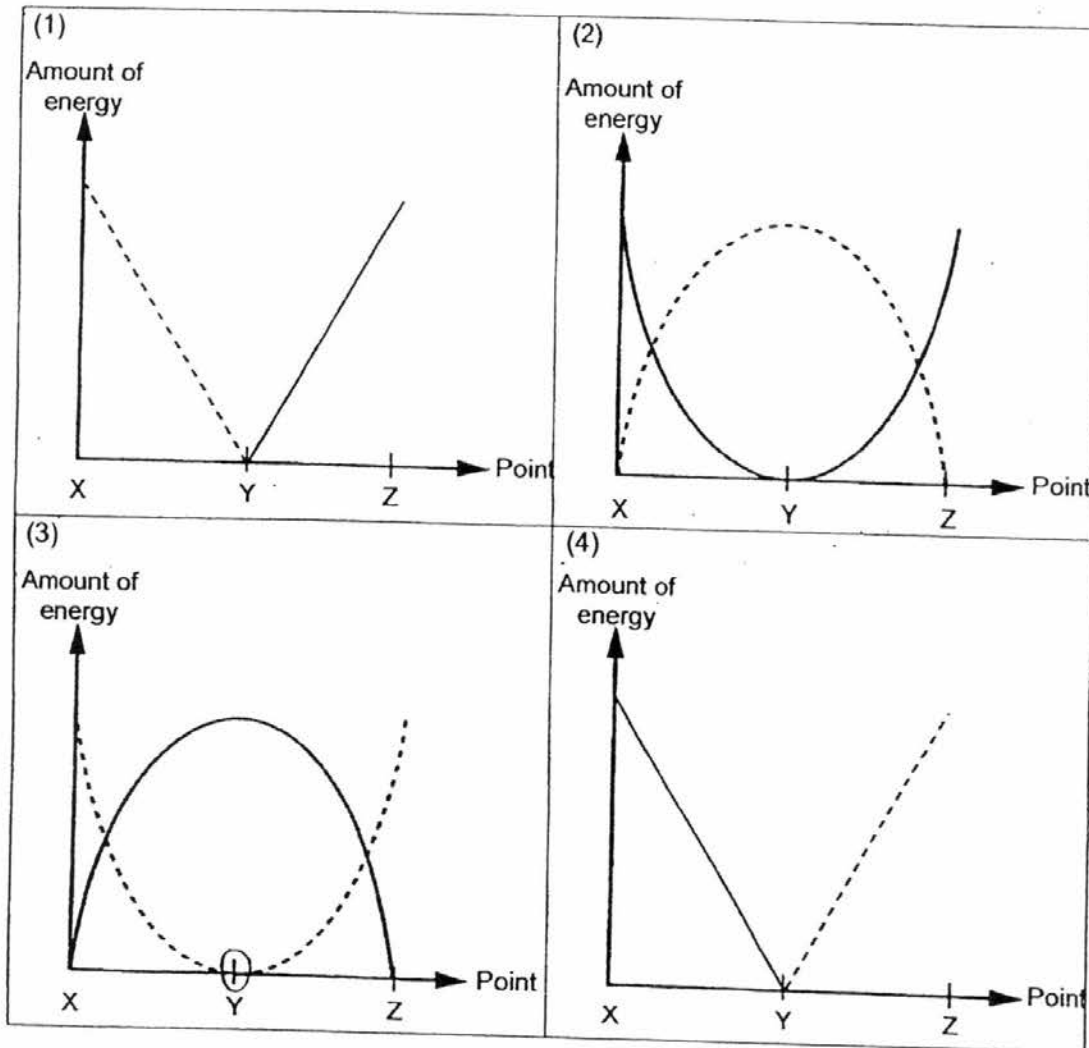

Anglo-Chinese School (Junior)



CONTINUAL ASSESSMENT 2 (2016) PRIMARY 5

SCIENCE

BOOKLET B

THURSDAY

25 AUGUST 2016

50 minutes

Name: _____ () Class: 5.() Parent's Signature: _____

INSTRUCTIONS TO PUPILS

DO NOT TURN OVER THE PAGES UNTIL YOU ARE TOLD TO DO SO

Follow all instructions carefully.

There are 6 questions in this booklet.

Answer **ALL** questions.

INFORMATION FOR PUPILS

The number of marks is given in brackets [] at the end of each question or part question.

The total marks for this booklet is 16.

The total time for Booklets A and B is 50 minutes.

This question paper consists of 7 printed pages (inclusive of cover page).

Booklet	Possible Marks	Marks Obtained
Practical	10	
A	24	
B	16	
Total	50	

Booklet B (16 marks)

For questions 13 to 18, write your answers in this booklet.

The number of marks awarded is shown in the brackets [] at the end of each question or part question.

- 13 Calvin carried out the experiment shown below. He tied a string to a stone and lowered it into a displacement can until it was completely submerged in the water.

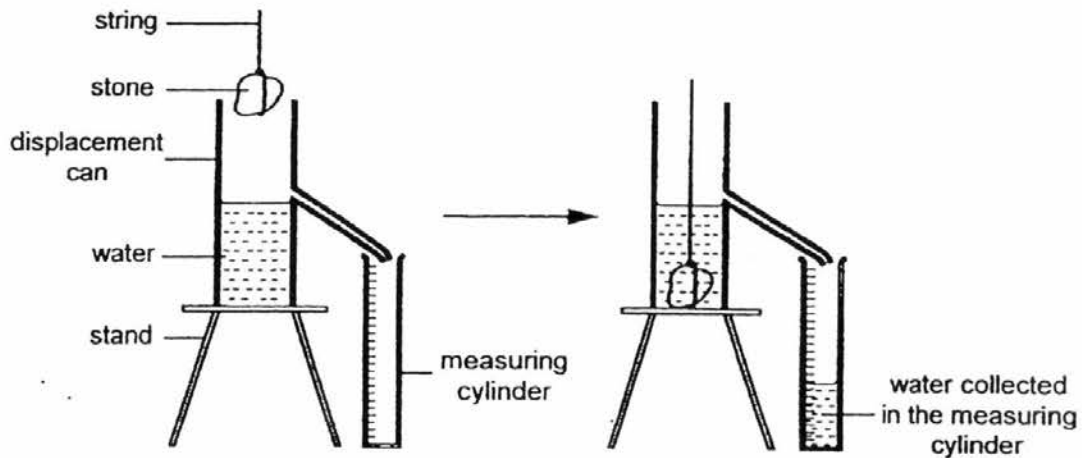

He repeated the experiment several times using the same set-up and found that the water collected in the measuring cylinder was always the same.

- (a) What does the water collected in the measuring cylinder represent? [1]

- (b) What property of a solid can you infer when the water collected in the measuring cylinder was always the same? [1]

(Go on to the next page)

SCORE	2
-------	---

- 14 Tom used a test magnet to find out the properties of 3 bars X, Y and Z, which are each made of a different material.

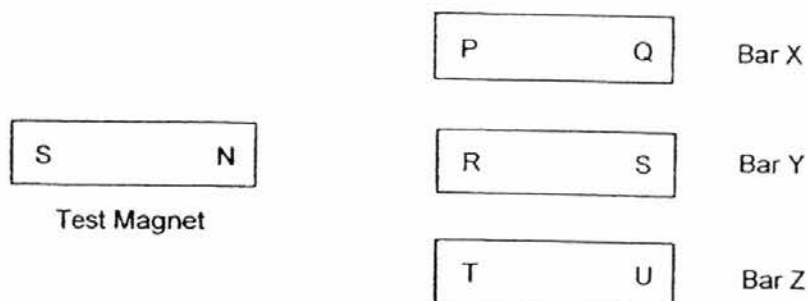

He brought the test magnet close to each bar and recorded the results of his experiment in the table below.

Bar	Observations
X	Both P and Q were attracted by the N-pole of the magnet when it was brought close to them.
Y	R was attracted to the N-pole of the magnet but S was repelled by the N-pole of the magnet when it was brought close to them.
Z	Neither T nor U was attracted by the N-pole of the magnet when it was brought close to them.

- (a) Which bar(s) is / are made of magnetic material? [1]

- (b) Which bar(s) is / are a magnet? Explain clearly the reason for your choice. [1]

(Go on to the next page)

SCORE	2
-------	---

15 The diagrams below show some cells.

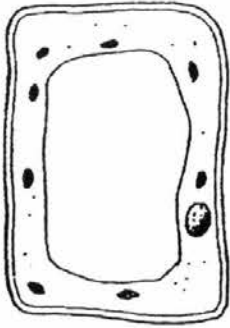

Cell A

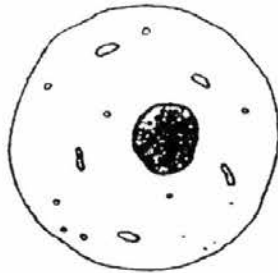

Cell B

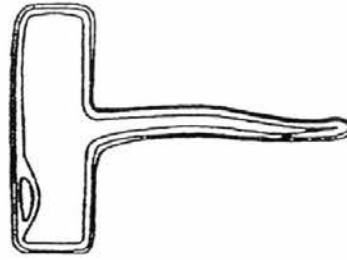

Cell C

- (a) Which of the cell(s) above is / are taken from a plant? Explain clearly the reason for your choice. [1]

- (b) What cell part is found in the cytoplasm of Cell A but not in that of Cell C? [1]

- (c) What is the function of the cell part mentioned in (b)? [1]

(Go on to the next page)

SCORE	3
-------	---

16 Nathan wanted to find out if the type of material used to make an electromagnet affects the number of steel thumbtacks attracted to it in a closed circuit. He set up the experiment as shown below :

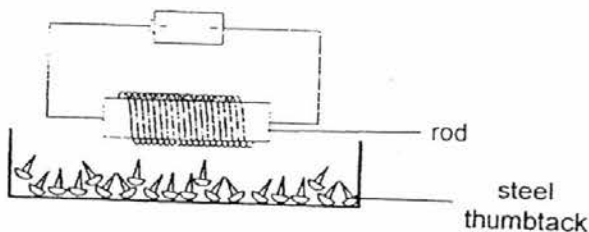

He kept a record of changed and unchanged variables in the table below. A tick (✓) indicates the variable that was changed / unchanged.

Variable	Variable Changed	Variable Unchanged
Material of the rod		✓
Thickness of the rod	✓	
Number of batteries		✓
Number of coils of wire around the rod		✓

(a) Explain why Nathan **could not** test the aim of his experiment. [1]

(b) If he corrected his experimental set-up and conducted the test again, how would using the same number of coils of wire around the rod ensure a fair test? [1]

Nathan carried out the experiment using rods of different materials A, B, C and D in the same set-up and recorded the results in the table below.

Rod	Number of steel thumbtacks attracted to the electromagnet
A	9
B	15
C	0
D	4

(c) Nathan observed that Rod C did not attract any steel thumbtacks in a closed circuit. What can he conclude about the property of material for Rod C? [1]

(Go on to the next page)

SCORE	3
-------	---

- 17 Jack set up an experiment as shown below.

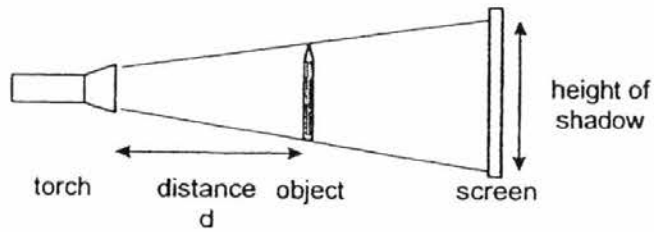

He shone the torch on the object and observed the **height of the shadow** that was formed on the screen. Keeping the **distance between the torch and the screen** the same, he changed the **distance between the object and the torch** and recorded the **height of the shadow** formed on the screen in the table below.

Distance d (cm)	Height of shadow (cm)
X	8
Y	4
Z	10

- (a) Arrange X, Y and Z from the **shortest** to the **longest** distance d . [1]

- (b) What are 2 **properties of light** which Jack can **infer** from the above experiment? [1]

- (c) What are 2 **variables** that Jack must **keep constant** so that the above experiment is a **fair test**? [1]

(Go on to the next page)

SCORE	
	3

18 The diagrams below show 2 methods in which electricity can be generated.

Method A

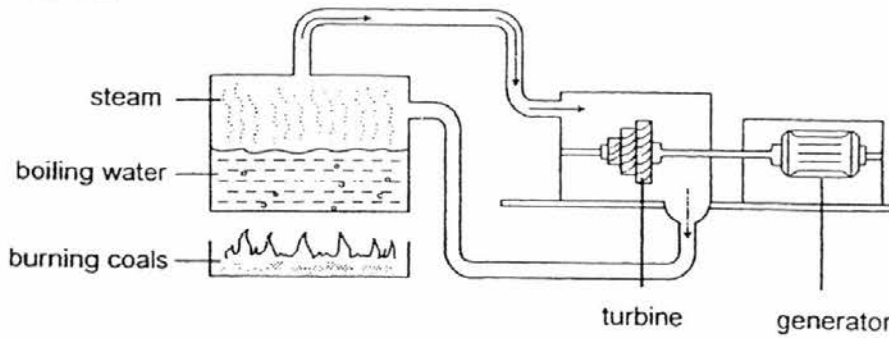

(a) Fill in the blanks to show the correct energy conversions for **Method A** of electricity generation. [1]

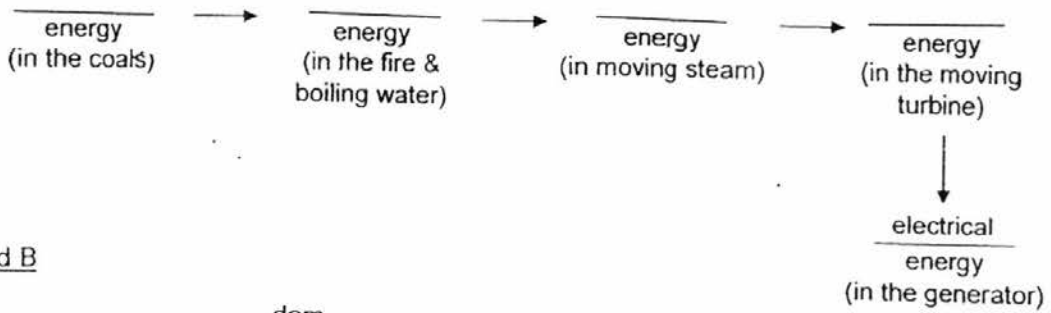

Method B

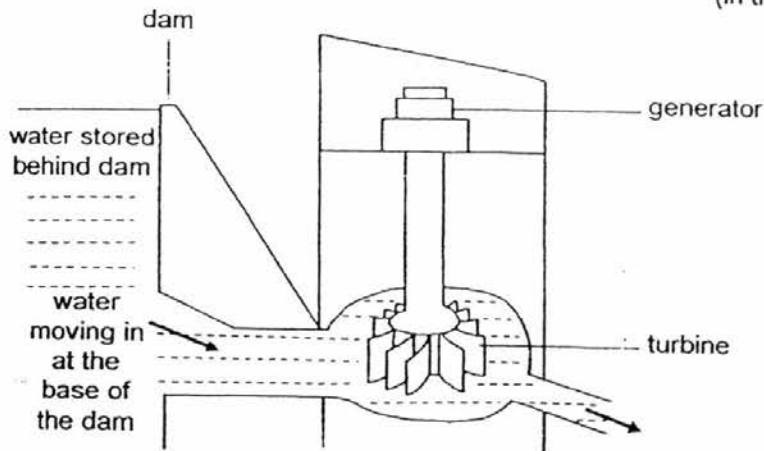

(b) What are 2 advantages of using Method B to generate electricity? [2]

(Go on to the next page)

SCORE	3
-------	---

End of paper

SEMESTRAL ASSESSMENT EXAM PAPER 2016

SCHOOL : ANGLO-CHINESE SCHOOL (JUNIOR)
SUBJECT : SCIENCE
TERM : CA2

BOOKLET A

Q1	Q2	Q3	Q4	Q5	Q6	Q7
2	4	4	3	2	2	1
Q8	Q9	Q10	Q11	Q12		
4	3	4	3	2		

BOOKLET B

Q13(a) The water collected in the measuring cylinder represents the value of the stone.

(b) I can infer that a solid has a constant volume.

Q14(a) Bars X and Y are made of multiple of magnetic materials.

(b) It repelled the test magnet and only a magnet can repel another magnet.

Q15(a) Cell A and Cell C are taken from a plant. Only plants have a cell wall and cells A and C have cell walls

(b) There is chloroplast in cell A but no chloroplast in cell C.

(c) They trap light and make food for the plant.

Q16(a) Nathan could not test the aim as he should change the material of the rod and not the thickness of the rod.

(b) It ensures that the results obtained will only be due to the material attracted.

(c) Nathan can conclude that rod C is made of a non-magnetic material.

Q17(a) Z, X and Y.

(b) Light travels in straight lines and light cannot pass through an opaque object.

(c) Jack must keep the number of batteries in the object and the object the same.

Q18(a) Potential → Heat → Kinetic → Kinetic → Electrical

(b) Method B does not require the burning of coals which will release toxic fumes and will never run out of water to generate electricity.

Z
END.