



AI TONG SCHOOL

2021 END-OF-YEAR EXAMINATION PRIMARY FIVE SCIENCE

(BOOKLET A)

28 OCTOBER 2021

Total time for booklets A and B : 1 h 45 min

INSTRUCTIONS

Do not turn over this page until you are told to do so.

Follow all instructions carefully.

Answer all questions.

Name : _____ ()

Class : Primary 5 _____

Parent's Signature : _____

Booklet A	56
Booklet B	44
Total	100

1

Section A (28 x 2 marks)

For each question from 1 to 28, four options are given. One of them is the correct answer. Make your choice and shade the correct oval (1, 2, 3 or 4) on the Optical Answer Sheet.

1. Which of the following characteristics is found in amphibians but **not** in reptiles?

- (1) They lay eggs.
- (2) They have moist skin.
- (3) They are covered with scales.
- (4) They breathe through their lungs.

2. Study the life cycles of two animals P and Q as shown in the diagram below.

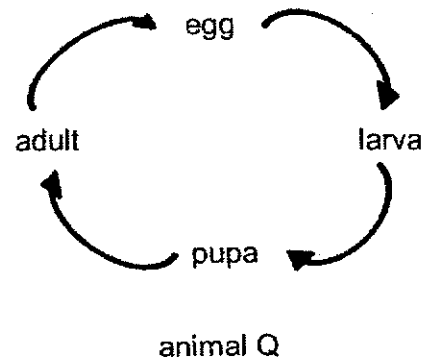
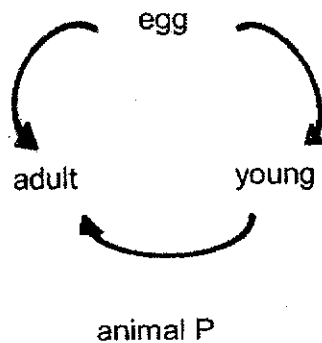

Based on the diagram above, which of the following statement(s) is/are correct?

- A Both the young of P and Q look like its adult.
- B Both the young of P and Q moult many times.
- C P takes a shorter time to develop from egg to adult stage than Q.

- (1) A only
- (2) B only
- (3) A and C only
- (4) B and C only

3. The table below shows characteristics of Leia and her parents.

Characteristics	Leia's father	Leia's mother	Leia
Colour of eyes	brown	black	brown
Length of hair	short	short	short
Eyelid	double	single	double
Earlobe	attached	detached	detached

How many characteristic(s) was/were passed down from Leia's mother to Leia?

- (1) 1
 (2) 2
 (3) 3
 (4) 4
4. The diagram below shows the reproductive system of a woman.

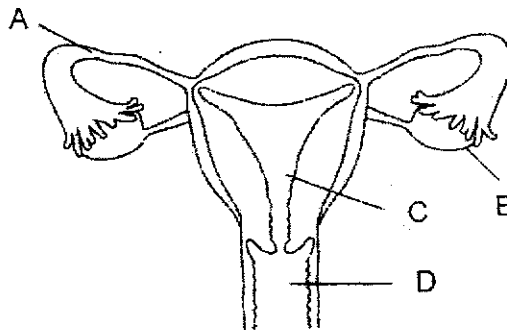

Which part of her reproductive system does a fertilised egg develop?

- (1) A
 (2) B
 (3) C
 (4) D

5. Sonya picked up a seed from her school garden. She carried out an experiment to find out the distance, d , travelled by the seed.

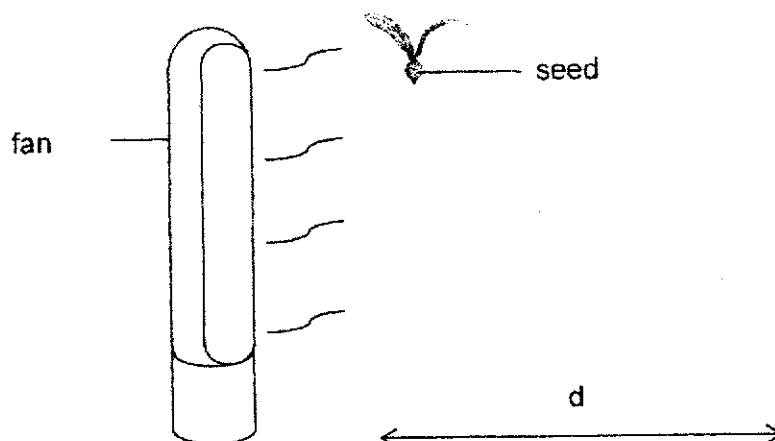

She plotted a graph as shown below.

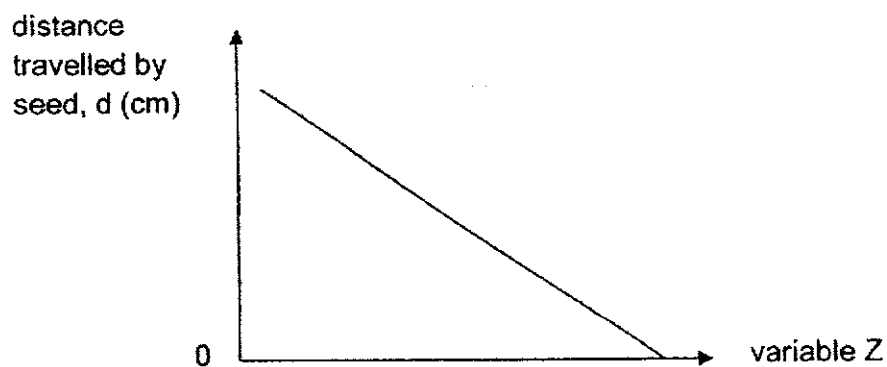

What is variable Z?

- (1) mass of seed
- (2) amount of wind
- (3) exposed surface area of seed
- (4) height of seed from the ground

6. Four students made the following statements about sexual reproduction in flowering plants .

Student	Statements
Abel	The stigma produces pollen grains.
Billie	Fertilised egg cell develops in the ovary.
Cara	Fertilisation takes place after pollination.
Daniel	Ovule fuses with the male reproductive cell during fertilisation.

Which of the students made correct statements about the reproduction in flowering plants?

- (1) Abel and Billie only
 (2) Abel and Daniel only
 (3) Billie and Cara only
 (4) Billie, Cara and Daniel only
7. The table below shows the characteristics of animal-pollinated and wind-pollinated flowers.

	Animal-pollinated flowers	Wind-pollinated flowers
A	produce nectar	do not produce nectar
B	more pollen grains produced	less pollen grains produced
C	feathery stigmas	sticky stigmas
D	larger petals	smaller petals

Which of the following is true about animal-pollinated and wind-pollinated flowers?

- (1) A and B only
 (2) A and D only
 (3) B and C only
 (4) C and D only

8. The diagram below shows the germination of a bean seed.

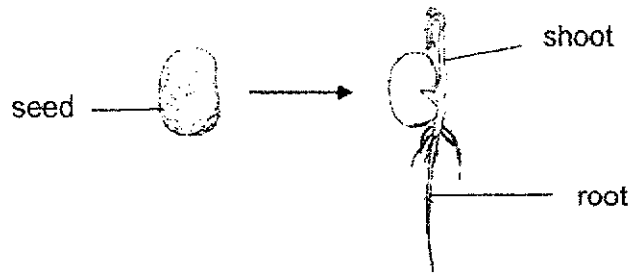

Bryan plotted a graph based on his observation of the length of the bean plant's root and shoot. The key of the graph is as shown below.

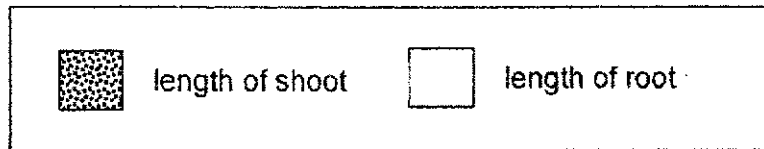

Which of the following graphs show the length of the ^{root} seed and shoot over 7 days?

(1) length of plant part (cm)

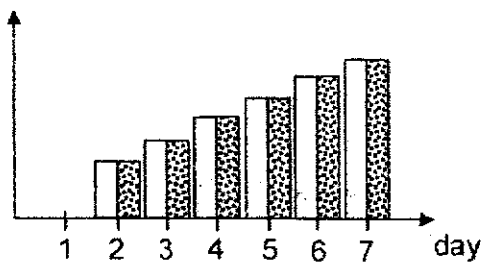

(2) length of plant part (cm)

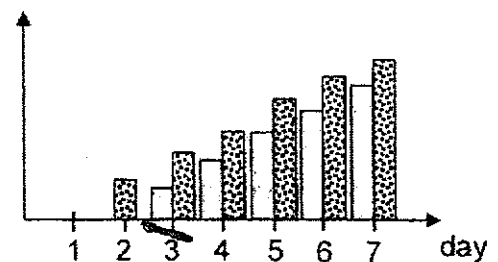

(3) length of plant part (cm)

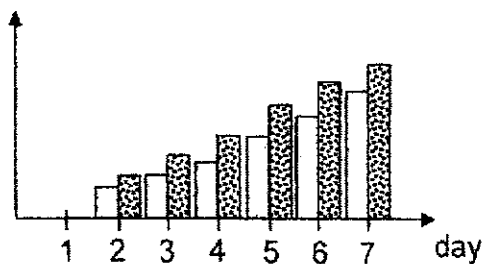

(4) length of plant part (cm)

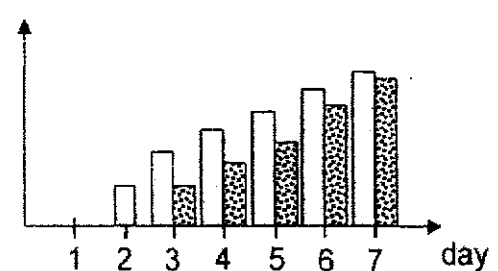

9. Which of the following substances are carried away from the foetus blood to the mother's blood through the umbilical cord?

- A oxygen
- B digested food
- C carbon dioxide
- D waste materials

- (1) A and C only
- (2) C and D only
- (3) A, B and C only
- (4) A, B and D only

10. The diagram below shows the movement of substances among systems X, Y and other parts of the body.

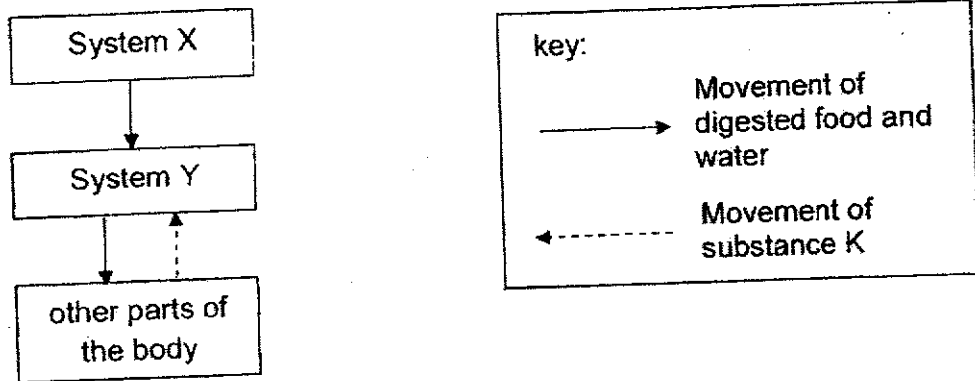

Which option correctly represents the systems and substance K?

	System X	System Y	Substance K
(1)	Digestive system	Respiratory system	Undigested food
(2)	Digestive system	Circulatory system	Carbon dioxide and waste
(3)	Respiratory system	Digestive system	Undigested food
(4)	Respiratory system	Circulatory system	Carbon dioxide and waste

11. The diagram below shows the direction of blood flow in some parts of the body.

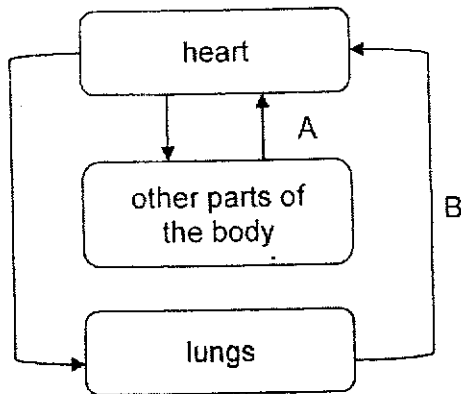

Which of the following graphs correctly shows the amount of oxygen and carbon dioxide at the blood vessels of A and B?

(1)

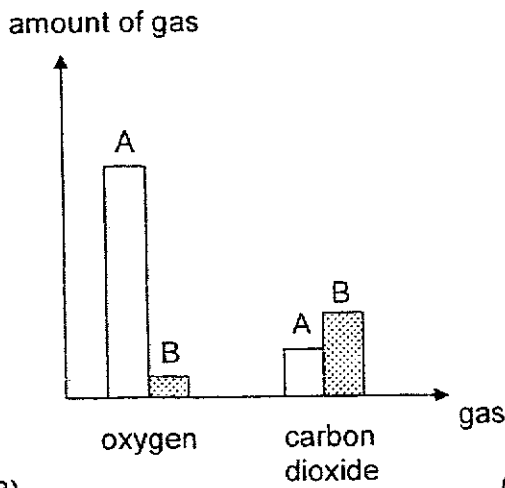

(2)

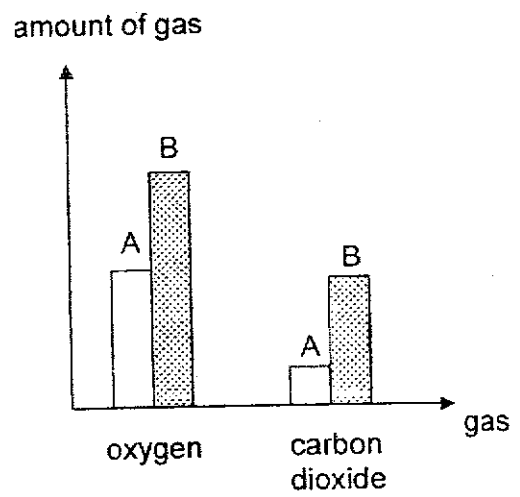

(3)

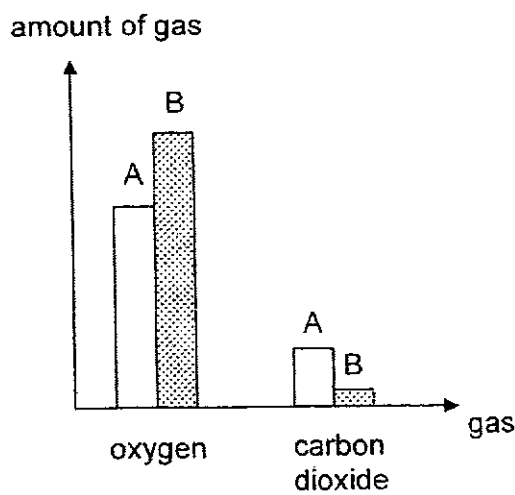

(4)

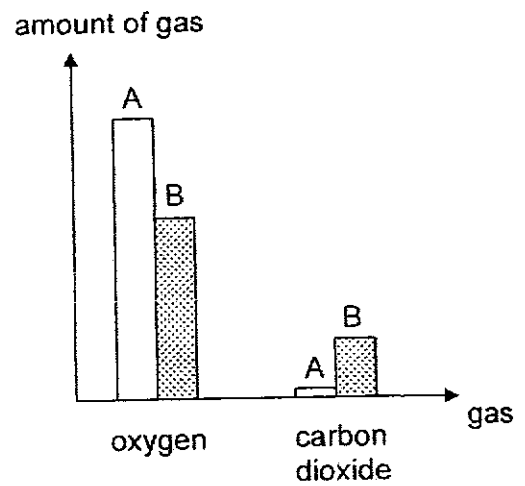



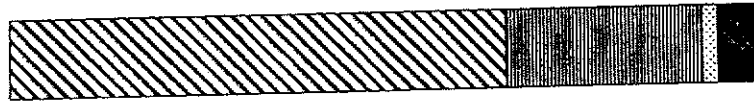

A-7

12. Two boys were trapped in a lift where no air could leave and enter. The diagram below shows the composition of four different gases in the lift when they first entered the lift.



Key: -

	nitrogen		oxygen		carbon dioxide		water vapour
---	----------	---	--------	---	----------------	---	--------------

Which of the following in the diagram shows the correct composition of the gases in the lift after one hour?

(1)

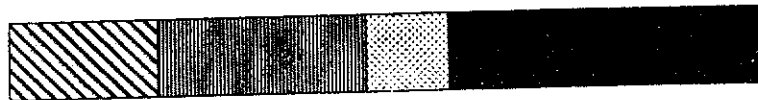

(2)



(3)

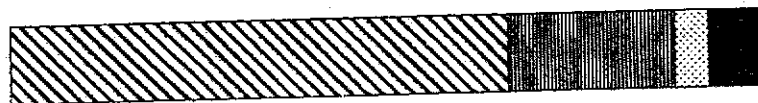

(4)



13. The table below shows the classification of four different cells.

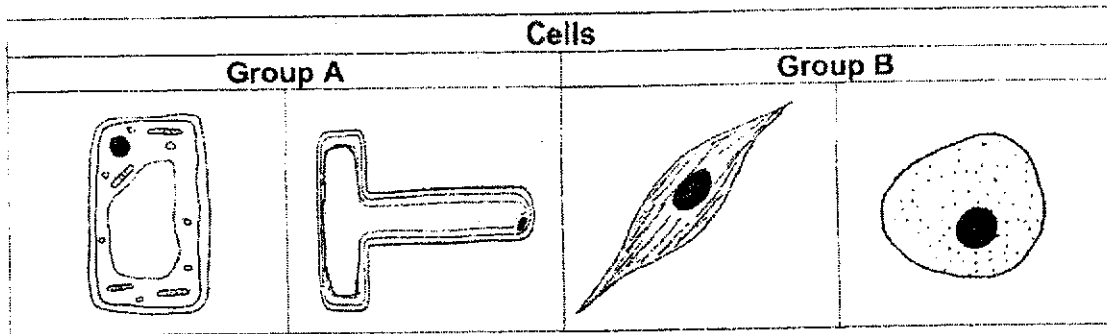

Which of the following options are suitable headings for group A and B?

	Group A	Group B
(1)	Have chloroplasts	Do not have chloroplasts
(2)	Have chloroplasts	Have cell membrane
(3)	Have cell wall	Have cell membrane
(4)	Have cell wall	Do not have cell wall

14. The graph below shows the height of Aster from age 0 to 20.

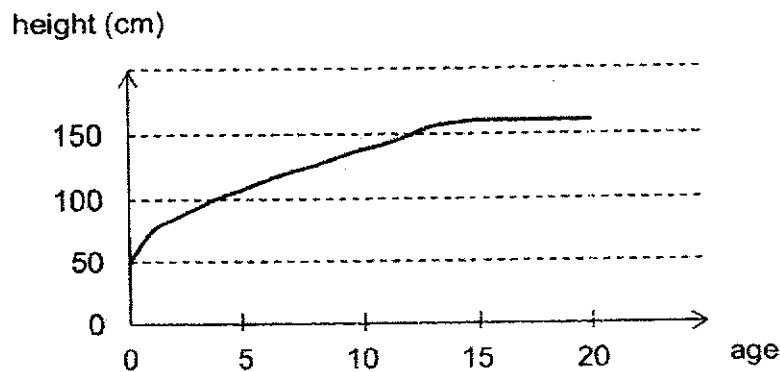

Which statements about Aster's growth are **incorrect**?

- A Aster grew taller as the size of her cells increased.
- B Aster grew taller as she grew different types of cells.
- C Aster grew taller as the number of cells increased.
- D Aster's cells stopped dividing when she was 20 years old.

- (1) A and B only
- (2) B and C only
- (3) C and D only
- (4) A, B and D only

15. Lucas found plant A growing around a tree trunk as shown below.

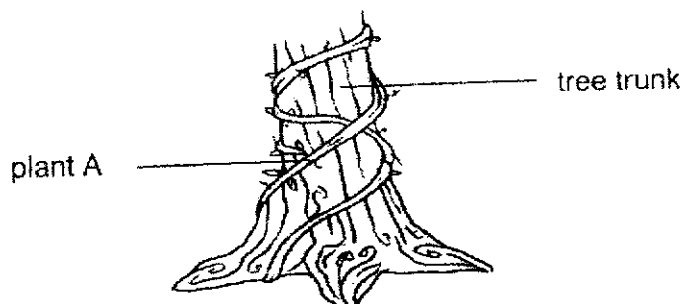

Which of the following statement is correct?

- (1) Plant A supports the tree to grow upright.
 - (2) Plant A anchors the tree trunk firmly to the ground.
 - (3) Plant A grows around the tree trunk to get more sunlight.
 - (4) Plant A grows around the tree trunk so that more water and mineral salts are transported to its leaves.
16. Samuel wanted to conduct an experiment on some leaves of a potted plant. The plant was then placed under the sun for a day. The leaves were tested for starch.

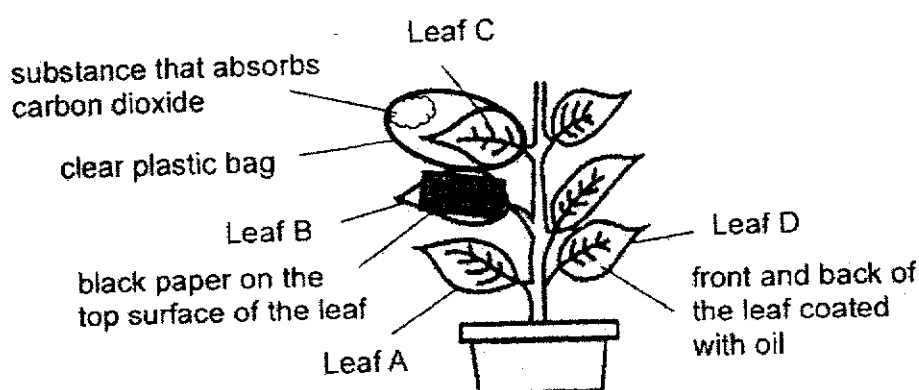

Based on the set-up above, which leaves should be used to achieve the aim of Samuel's experiment?

	Leaf	Leaf	Aim of experiment
(1)	B	C	To find out if light affects photosynthesis
(2)	A	D	To find out if gaseous exchange affects photosynthesis
(3)	A	C	To find out if presence of oxygen affects photosynthesis
(4)	B	D	To find out if the amount of carbon dioxide affects photosynthesis

17. Maria wanted to investigate the gaseous exchange of different living things, so she set up the experiment as shown below. Both tanks, Q and R, are identical in size and were covered with black paper.

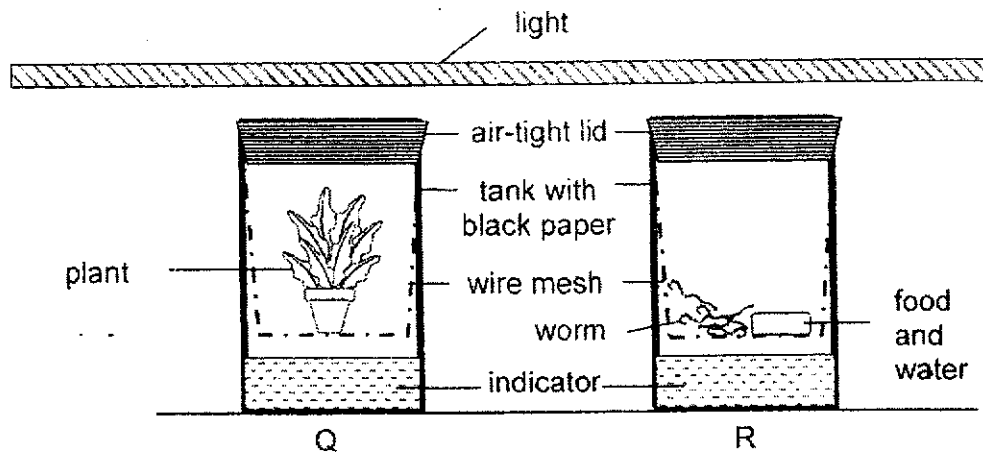

Maria carried out the experiment over a day. She added the same amount of indicator, which detects the amount of carbon dioxide in the air, in the container. The table below shows the colour change of the indicator according to the amount of carbon dioxide detected.

Colour of indicator		Amount of carbon dioxide
At the start of the experiment	At the end of the experiment	
red	purple	Less than normal
	red	normal
	yellow	more than normal

Which of the following would be Maria's observation of the indicator the next day?

	Colour of indicator in Q	Colour of indicator in R
(1)	purple	purple
(2)	yellow	yellow
(3)	red	red
(4)	purple	yellow

18. The diagram below shows a fisherman capturing fishes on a boat with a fishing net.

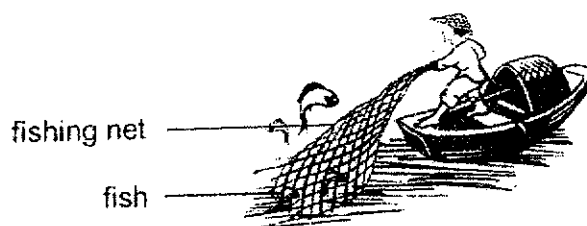

Which of the following states the properties the fishing net must definitely have?

	Strength	Waterproof	Flexibility	Ability to float
(1)	✓	x	x	x
(2)	✓	x	✓	x
(3)	x	✓	✓	✓
(4)	✓	✓	✓	✓

19. Elise wanted to find out the strengths of different exercise bands, A, B, and C. She tied each exercise band to the door frame and counted the number of steps she took to pull the exercise band before it broke, as shown in the diagram below.

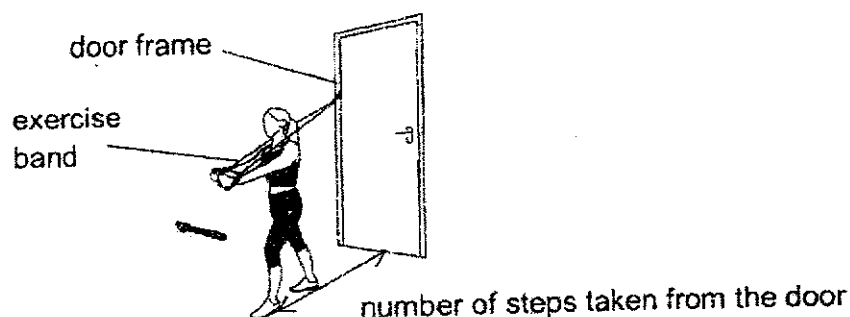

Which of the following factor(s) should she keep constant for a fair experiment?

- A** Material of the exercise bands
B Time taken for the exercise band to break
C Amount of force she took to pull each exercise band
D Number of steps she took to pull each exercise band
- (1) A only
 (2) C only
 (3) B and D only
 (4) A, B and D only

20. Naveen listed ways to conserve water at home.

- A Washing the car with a water hose
- B Using water from a running tap to brush teeth
- C Using a washing machine to wash a t-shirt only
- D Watering plants with the water that was used to wash rice

Which of the following way(s) stated above did **not** help with conservation of water at his home?

- (1) D only
- (2) B and D only
- (3) A, B and C only
- (4) A, C and D only

21. The table below shows the freezing and boiling points of three unknown substances at various temperatures.

Substance	Freezing point (°C)	Boiling point (°C)
T	5	98
U	45	120
V	85	480

At which temperature will all substances be in liquid state?

- (1) 40°C
- (2) 75°C
- (3) 96°C
- (4) 210°C

22. The graph below shows the changes in temperature of a bowl of water that was placed over a heat source. It was left to boil for some time. After which, the heat source was turned off. After some time, the bowl of water was placed in the freezer.

temperature ($^{\circ}\text{C}$)

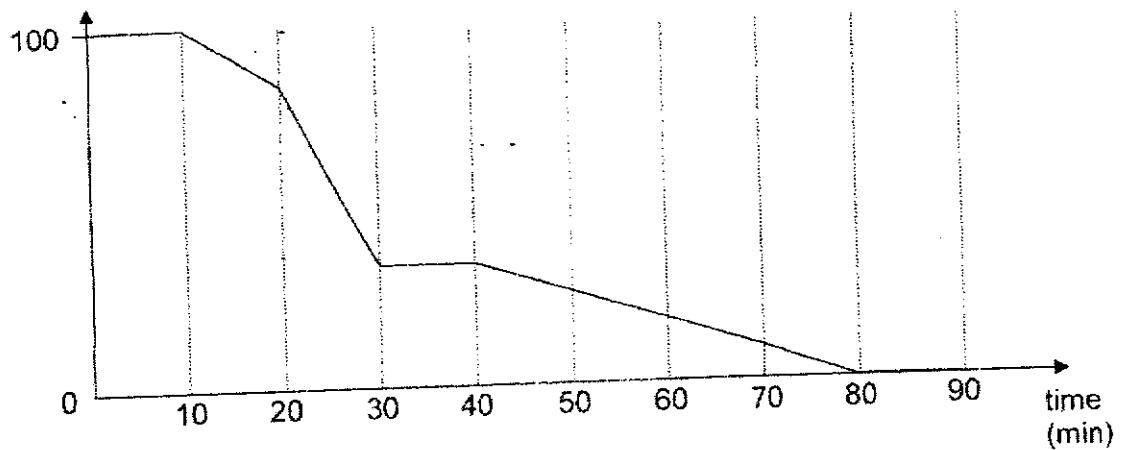

Which of the following statements are true?

- A From the 0th to 10th minute, water did not gain heat.
- B Water lost heat to the surrounding air from the 10th to 30th minute.
- C Water was placed in the freezer from the 40th to 90th minute.
- D Water existed in only two states from the 0th to 90th minute.

- (1) A and D only
- (2) B and C only
- (3) B and D only
- (4) C and D only

23. Weixin had two identical syringes, X and Y. He filled syringe X with substances Q, R and S and syringe Y with substances R and S. He placed his finger at the tip of each syringe and pressed each plunger down.

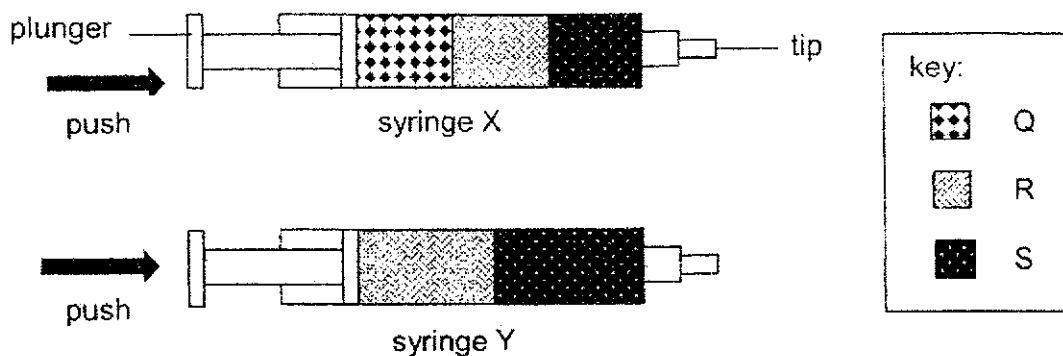

Weixin noticed that he could push the plunger of syringe X in, but not syringe Y.

Based on the results of the experiment, which of the following options are true about substances Q, R and S?

- A Q can be compressed.
 - B R and S have a definite shape.
 - C Q, R and S have the same mass.
 - D The volume of R and S remained the same when the plunger of syringe X was pushed down.
- (1) A and D only
 (2) B and C only
 (3) B and D only
 (4) A, B, C and D

24. Ariel put some marbles in a measuring cylinder which reached the level of 150 cm^3 . Next, she poured some water into the measuring cylinder as shown in the diagram below. The water level rose to 250 cm^3 .

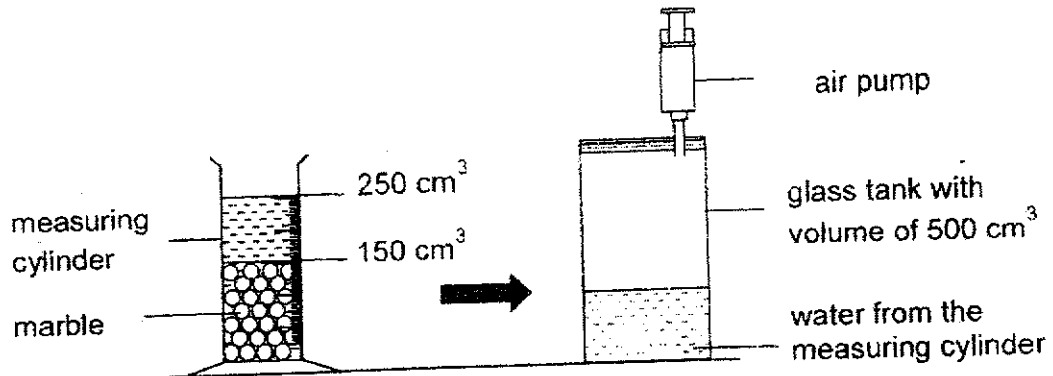

Ariel poured all the water in the measuring cylinder to the glass tank. Lastly, she pumped 100 cm^3 of air into the glass tank. What is the possible volume of air in the glass tank?

- (1) 100 cm^3
- (2) 250 cm^3
- (3) 350 cm^3
- (4) 450 cm^3

25. Jiawen has a bar magnet and he labelled the parts of the magnet as shown in the diagram below.

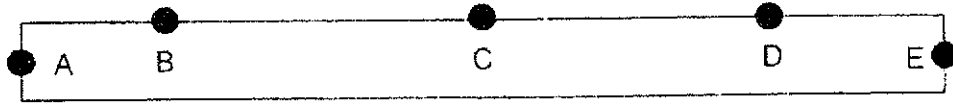

He placed the bar magnet into a tray of iron pins and recorded the number of iron pins attracted at each part of the bar magnet as shown in the table below.

Part of the magnet	A	B	C	D	E
Number of iron pins at each part of the magnet	6	3	1	3	7

Moments later, Jiawen dropped the bar magnet down a flight of stairs. Next, he repeated the experiment and recorded the number of iron pins at each part of the magnet.

Which of the following shows the results of his second experiment?

	A	B	C	D	E
(1)	5	3	1	3	6
(2)	0	1	0	1	4
(3)	1	3	0	3	1
(4)	3	1	0	1	3

26. Owen created a game using the set-up as shown below. He made two identical circuits. To begin, a ball was placed at the start point. When the switches of both circuits were closed, Owen pushed the ball down the lane between the two circuits.

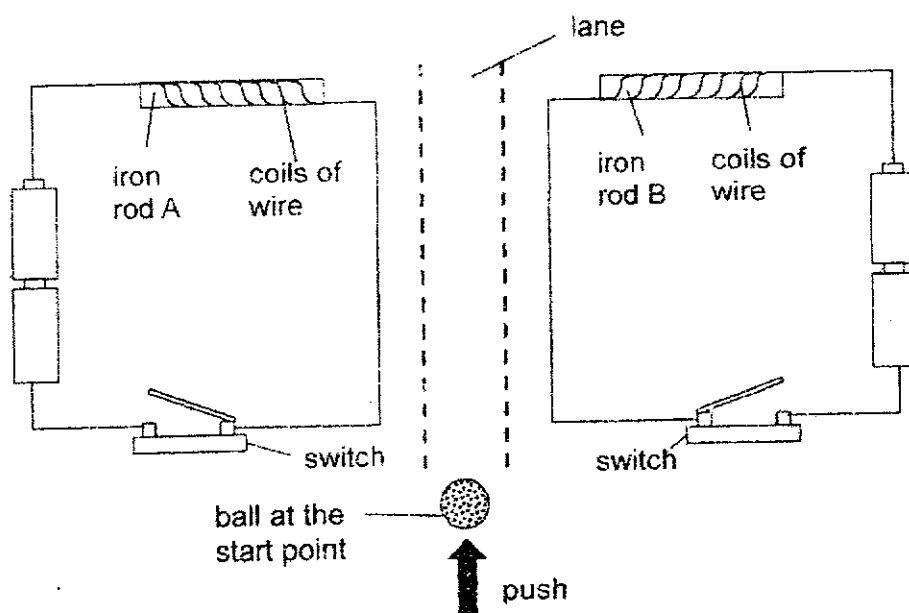

Which of the following options allow the ball to move towards iron rod A only?

- A Change the iron rod B to a copper rod.
 - B Increase the distance between iron rods A and B.
 - C Remove a battery from the circuit with iron rod A.
 - D Decrease the number of coils of wire around iron rod B.
- (1) A and C only
- (2) A and D only
- (3) B and C only
- (4) B and D only

27. The diagram below shows three objects with the following heights and widths.

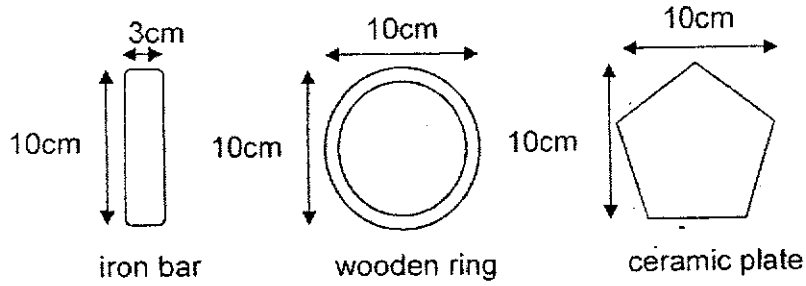

The objects are placed at each position, Q, R and S, from a torch light. Their shadows are cast on a screen as seen in the diagram below.

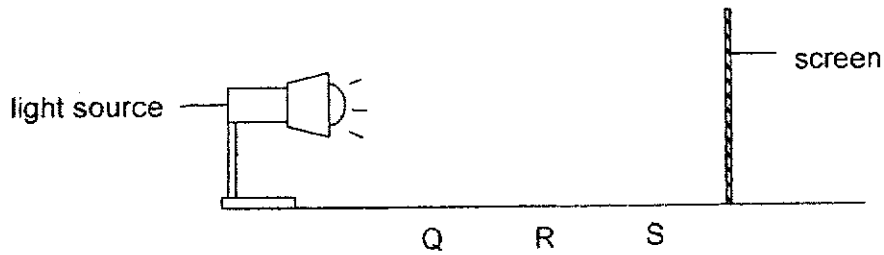

Which of the following are possible shadows that can be formed on the screen?

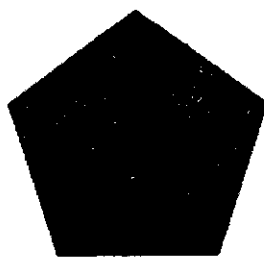

Shadow A

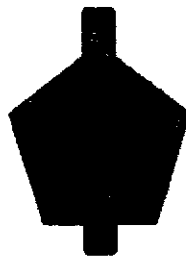

Shadow B

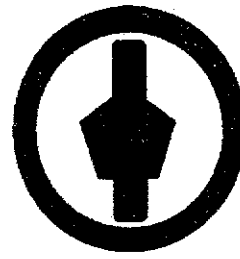

Shadow C



Shadow D

- (1) A and B only
- (2) B and C only
- (3) C and D only
- (4) A, B and C only

28. Vanessa placed a metal spoon in bowl X and a wooden spoon in bowl Y. Both contained ice-cream. She removed both bowls of ice-cream from the refrigerator and placed them on the kitchen table as shown in the diagram below.

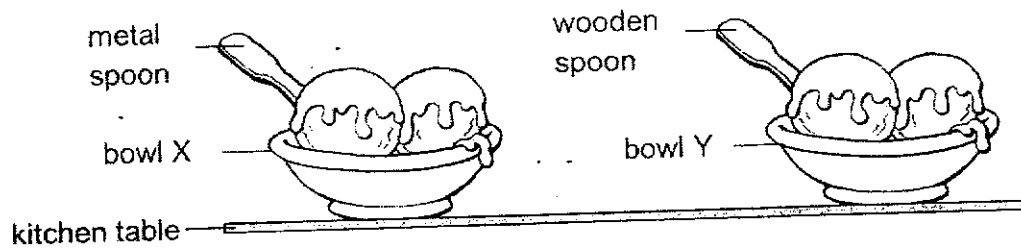

Vanessa recorded her observations after 15 minutes.

Which of the following statements about Vanessa's observations are correct?

- A** The ice-cream in bowl X melts faster than Y.
 - B** The ice-cream in bowl Y has a higher temperature than X.
 - C** The metal spoon has a lower temperature than the wooden spoon.
 - D** When she touches the spoons, the metal spoon feels colder than the wooden spoon.
- (1) A and D only
 (2) B and C only
 (3) C and D only
 (4) A, C and D only

End of Booklet A

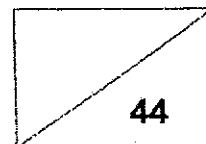
**AI TONG SCHOOL****2021 END-OF-YEAR EXAMINATION
PRIMARY FIVE SCIENCE****(BOOKLET B)****28 OCTOBER 2021****Total time for booklets A and B : 1 h 45 min****INSTRUCTIONS****Do not turn over this page until you are told to do so.****Follow all instructions carefully.****Answer all questions.****Write your answers in this booklet.****Name : _____ ()****Class : Primary 5 _____****Parent's Signature : _____**

Section B: 44 marks

Read the questions carefully and write down your answers in the spaces provided.

29. Callen placed a bean seed on a wet cotton wool in a dish. Hours later, he observed that the seed coat had split, as shown in the diagram below.

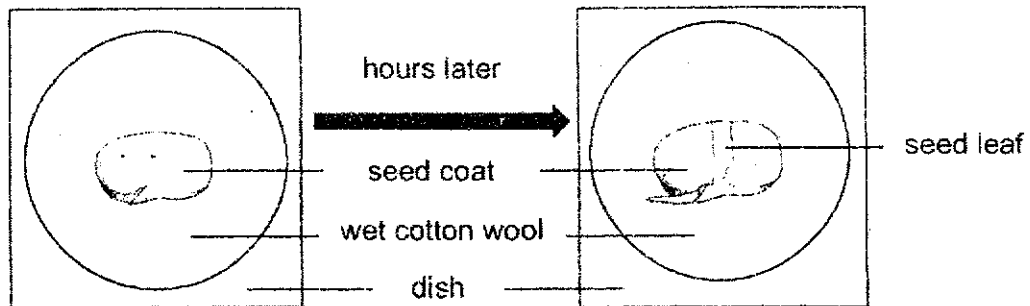

- (a) Give a reason for Callen's observation.

[1]

Callen drew a graph. It shows the mass of the seed leaf as the seed germinates. However, the graph is incomplete.

- (b) Complete the graph below to show the change in mass of the seed leaf.

[1]

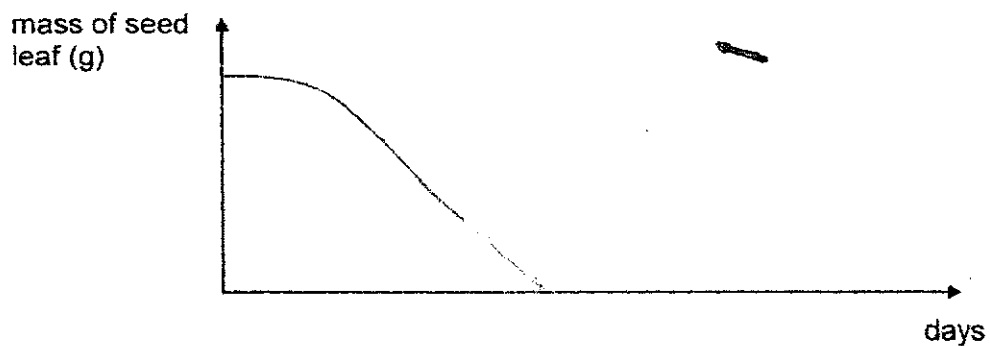

(Go on to the next page)

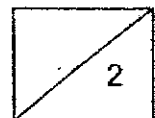

B-1

30. (a) Describe the process of photosynthesis in green plants. [1]

Weiqian conducted an experiment on a plant. She removed the outer ring from the stem as shown in the diagram below.

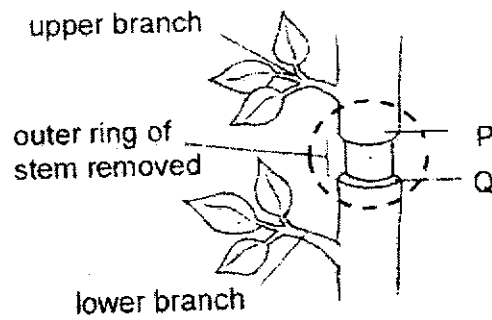

A week later, Weiqian noticed that the stem became swollen.

- (b) Explain why the parts P and Q had become swollen. [2]

- (c) A few weeks later, Weiqian observed that the plant did not die even though the outer ring of the stem was removed. Explain her observation. [1]

(Go on to the next page)

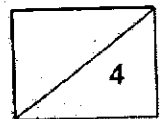

31. Liam studied cell A under the microscope as shown in the diagram below.

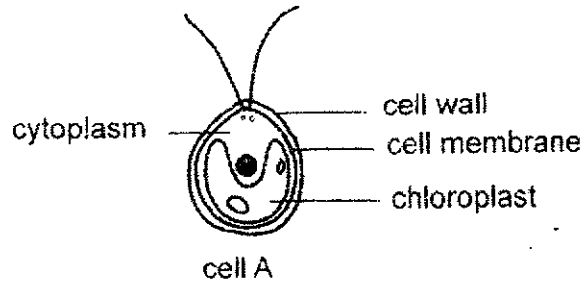

(a) Is cell A a plant cell? Explain your answer. [1]

(b) State the function of cytoplasm in cell A. [1]

Next, Liam conducted an experiment with the set-up as shown below. He poured a mixture of water and sand on object X that was placed in a funnel. An hour later, he observed that only water was collected in the container below the funnel.

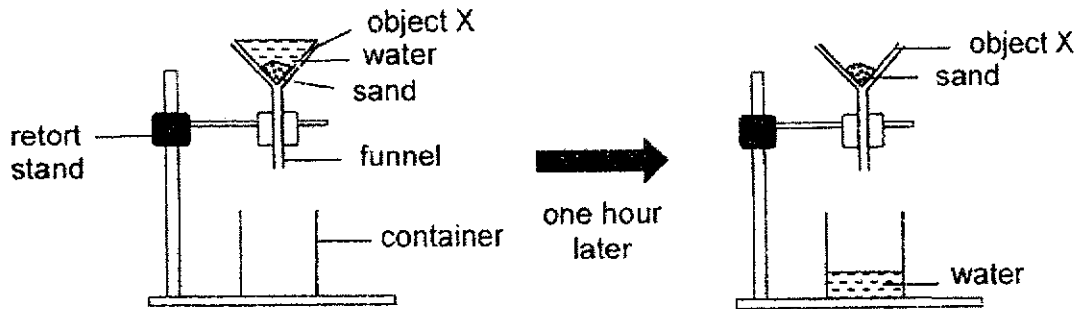

(c) Which cell part in cell A has the same function as object X? Explain your answer. [2]

(Go on to the next page)

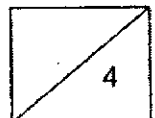

32. Study the flowchart below.

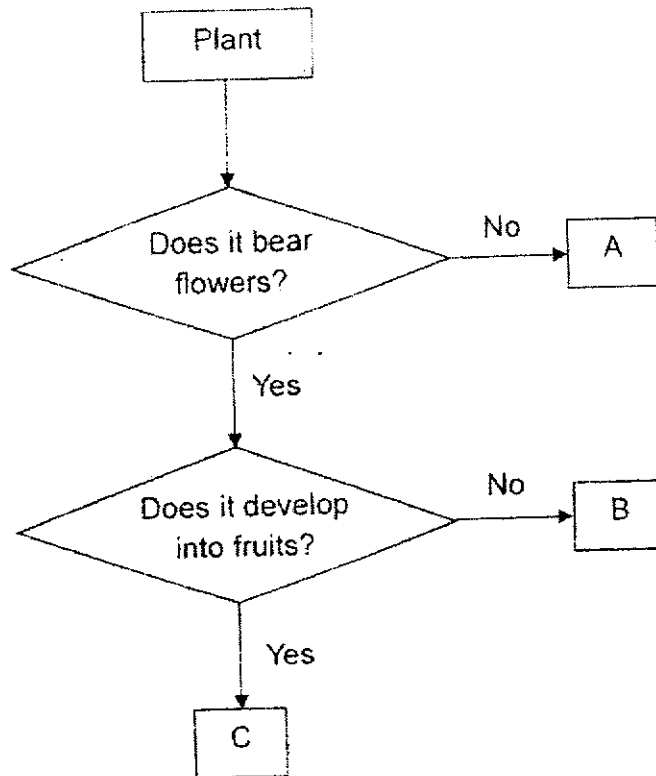

(a) How does A reproduce? [1]

(b) Based on the flowchart, which flower in the table below best represents plant B and C? Write B and C in the respective blanks below. [1]

Plant _____	Plant _____

Question 32 continues on the next page.

Question 32 continues.

The diagram below shows the growth of the seedlings of plants Q and R found at different distances away from the parent plant.

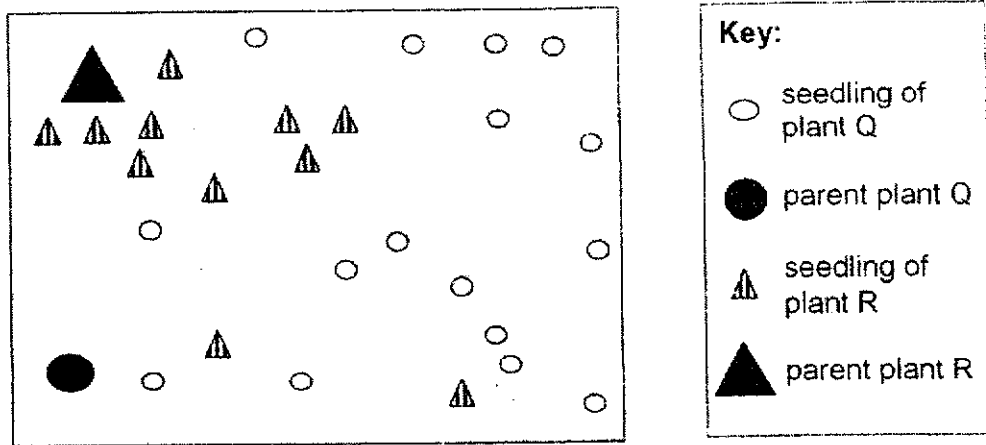

The following fruits, 1 and 2, belongs to either plant Q or plant R.

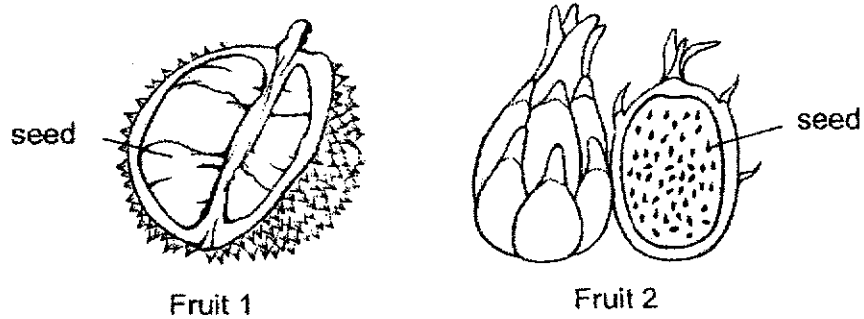

(c) Which fruit, 1 or 2, belongs to plant Q? Explain your answer. [2]

(Go on to the next page)

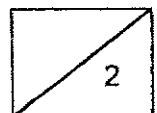

33. Study the diagram of the human body system below.

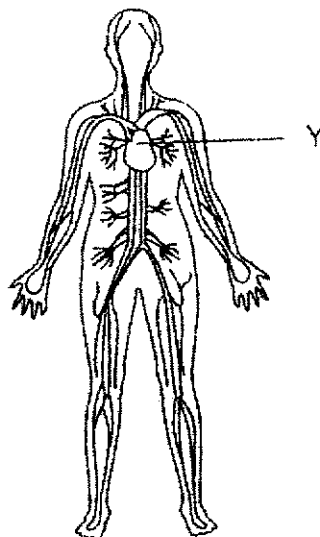

- (a) What is the function of Y?

[1]

Tanisha wanted to find out how exercise affects pulse rate. She measured the pulse rate of three friends when resting and after exercising for 30 minutes.

Friend	Pulse rate when resting (per minute)	Pulse rate after exercising for 30 minutes (per minute)
Jon	65	89
Kaili	65	95
Liyana	72	100

- (b) Based on her results, what can Tanisha conclude for her experiment?

[1]

Question 33 continues on the next page.

B-6

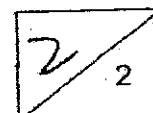

Question 33 continues.

The graph below shows the rate of blood flowing to the muscles of Jon's body when he was resting and exercising.

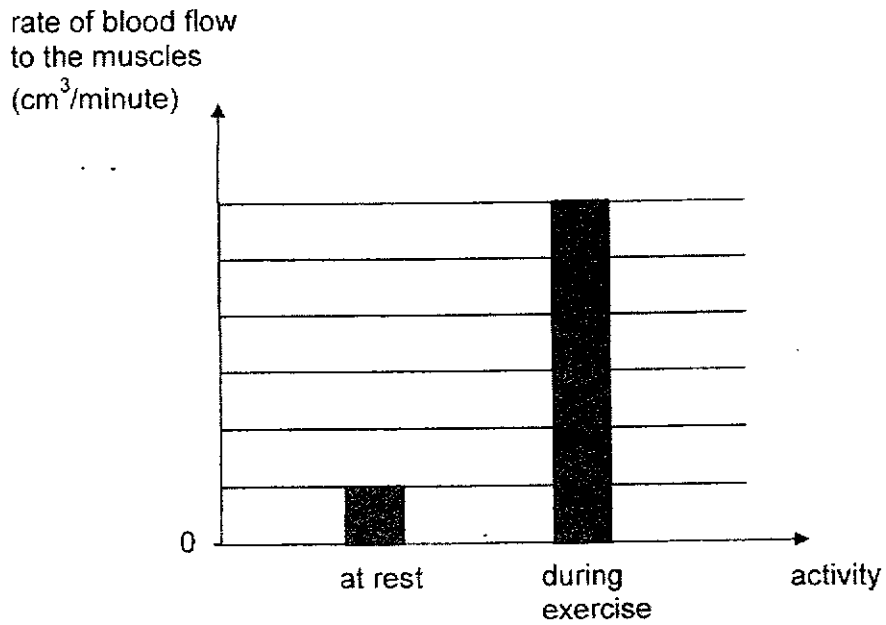

- (c) Explain the difference in blood flow to Jon's muscles when he was exercising compared to when he was at rest. [2]

(Go on to the next page)

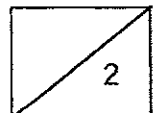

B-7

34. (a) Name two organs in the digestive system that do not carry out digestion. [1]

(i) _____

(ii) _____

Mr Wong has a disease that affects his small intestine. The diagram below shows the magnified view of the structures found on the wall of his small intestine before and after he had the disease.

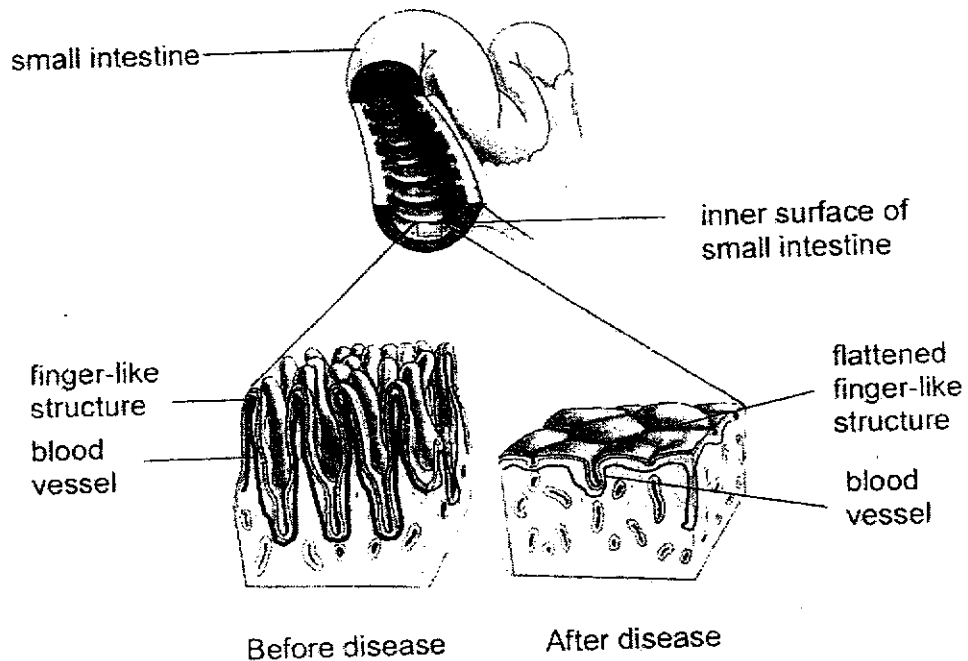

After having the disease, Mr Wong observed that he had lost weight despite eating the same amount of food every day as before.

(b) Using the information in the diagram, explain Mr Wong's observation. [2]

(Go on to the next page)

35. Rani wanted to test the property of three materials, P, Q and R, using the set-up as shown below. She placed each material between the clamps below and recorded the maximum mass that can be placed on each material before it breaks.

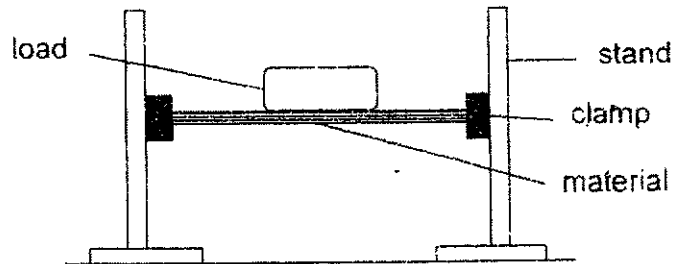

She recorded the results of her experiment in the table below.

Material	P	Q	R
Maximum mass of the load placed on each material (kg)	80	100	20

- (a) Suggest what Rani can do to improve on the reliability of her results. [1]

Rani wanted to select a material that can be used for the track of cable cars, as shown in the diagram below.

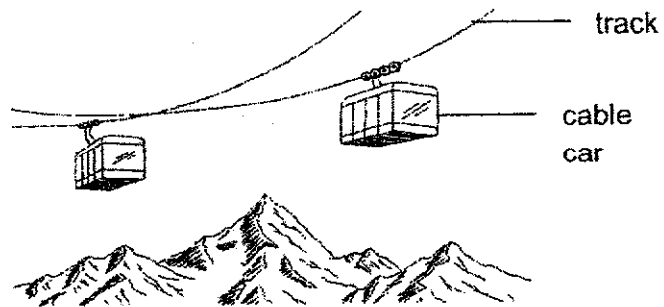

- (b) Based on the results, which material, P, Q or R, is the most suitable to make the track of the cable cars? Explain your answer. [1]

(Go on to the next page)

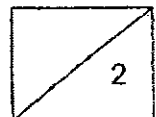

36. Craig set up the experiment as shown below in a dark room to find out how light intensity affects the rate of photosynthesis of plants.

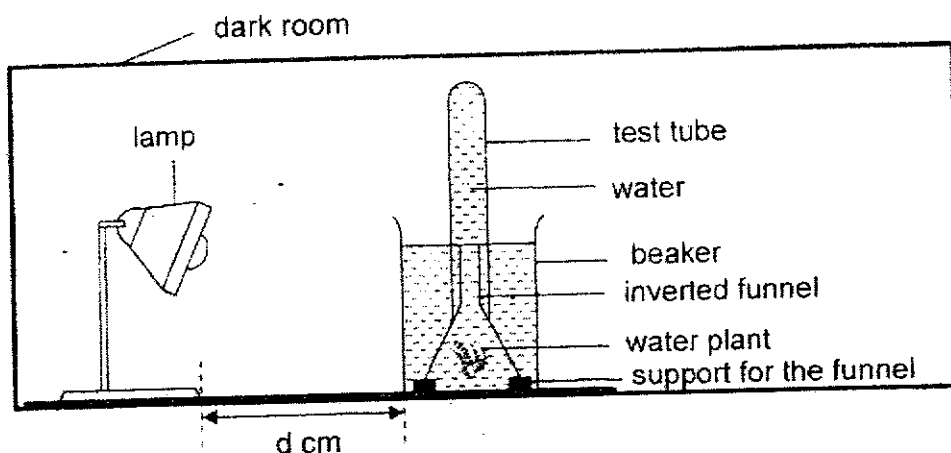

He placed a lit lamp at different distances from the beaker (d cm) and measured the amount of gas K produced in the test tube as shown in the diagram below.

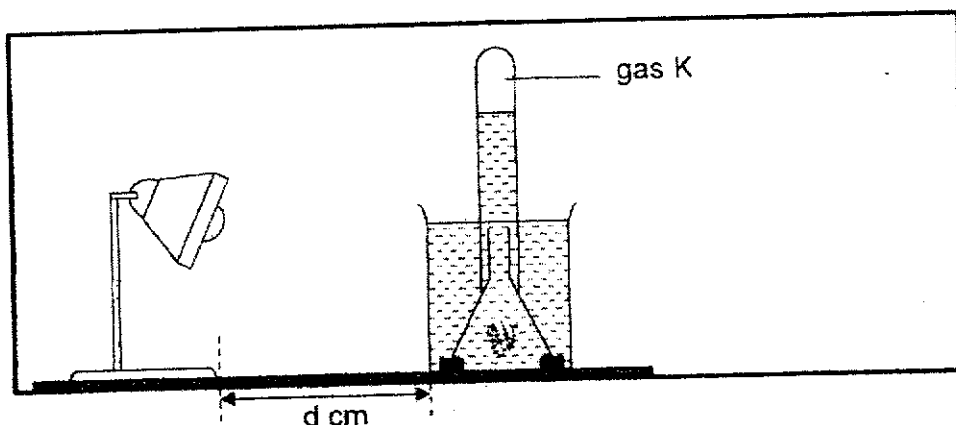

Craig recorded the results in the table below.

d (cm)	35	30	25	20	15	10	5
Amount of gas K produced (cm³)	10	20	28	32	40	40	40

- (a) Based on Craig's results, what is the relationship between the distance of the lamp from the water plant and the rate of photosynthesis? [1]

Question 36 continues on the next page.

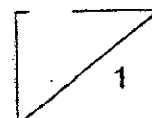

Question 36 continues.

- (b) Besides changing the distance of the lamp from the water plant, state another way Craig can increase the amount of gas K formed in the test tube. [1]

- (c) Explain why Craig had to fill the test tube completely with water at the start of the experiment. [1]

Craig set up another experiment to investigate if blue-coloured light affects the rate of photosynthesis as shown in the diagram below.

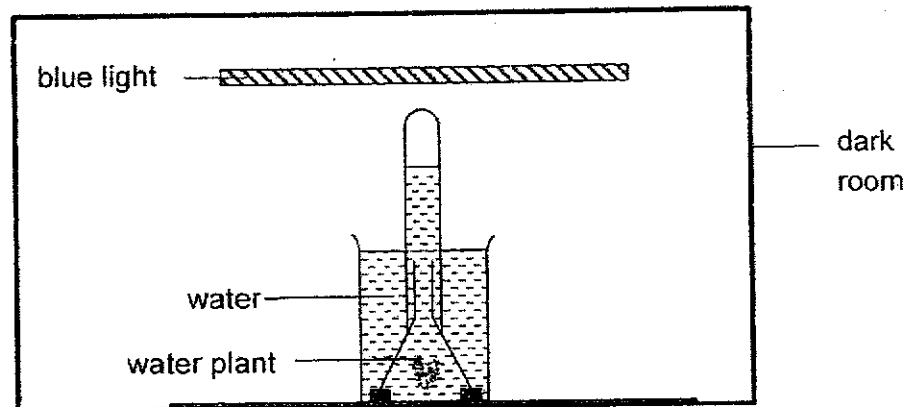

His teacher informed him that he needed a second set-up using white light.

- (d) Explain how having the second set-up can help Craig in his experiment. [2]

(Go on to the next page)

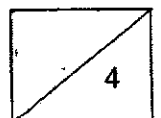

37. During Science lesson, Desmond learnt that Singapore has started building the largest solar farm on Tengeh Reservoir as shown in the diagram below. Solar panels are placed on floats, which are placed on the water of the reservoir.

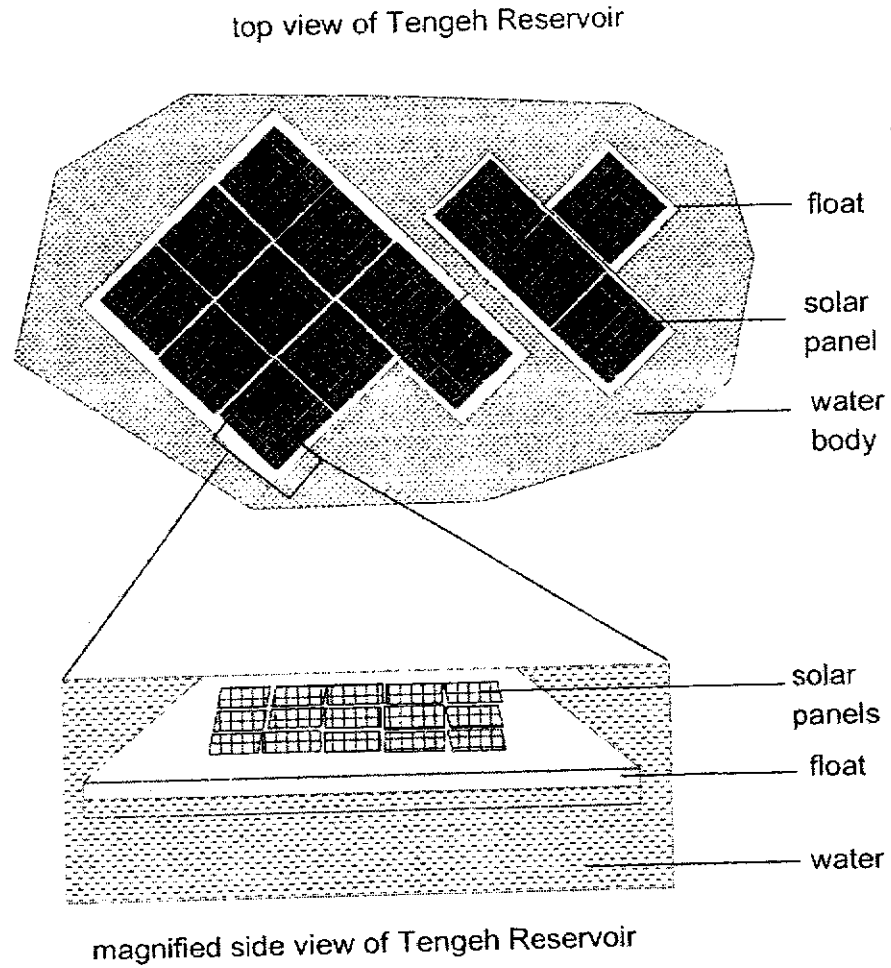

- (a) Explain why placing the solar panels on the water surface reduces water loss from the reservoir. [2]

Question 37 continues on the next page.

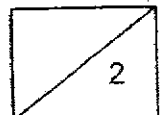

Question 37 continues.

- (b) Name two other factors that will affect the rate of evaporation of water. [1]

Upon reaching home after school, Desmond took out an ice-cream from the freezer and removed its wrapper. He placed it on a plate in his kitchen. A few minutes later, he noticed white solid forming on the surface of the frozen ice-cream as shown in the diagram below.

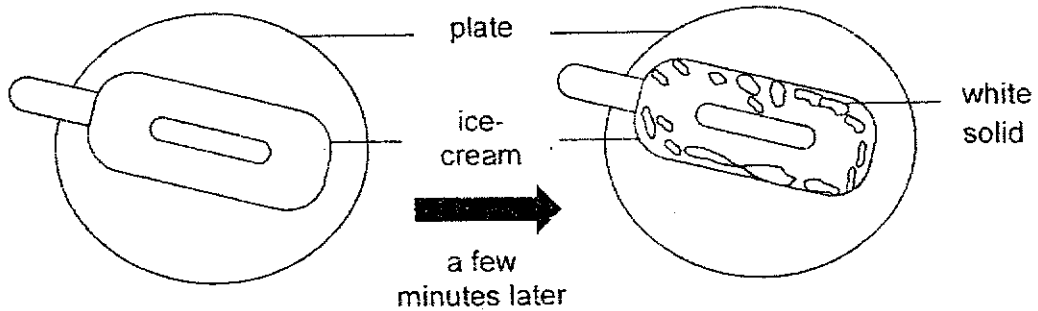

- (c) Explain how the white solid was formed on the ice-cream. [2]

(Go on to the next page)

38. Jim set up the following experiment to find out the components of substance X. Substance X passes through flasks A, B and C in the direction of the arrows.

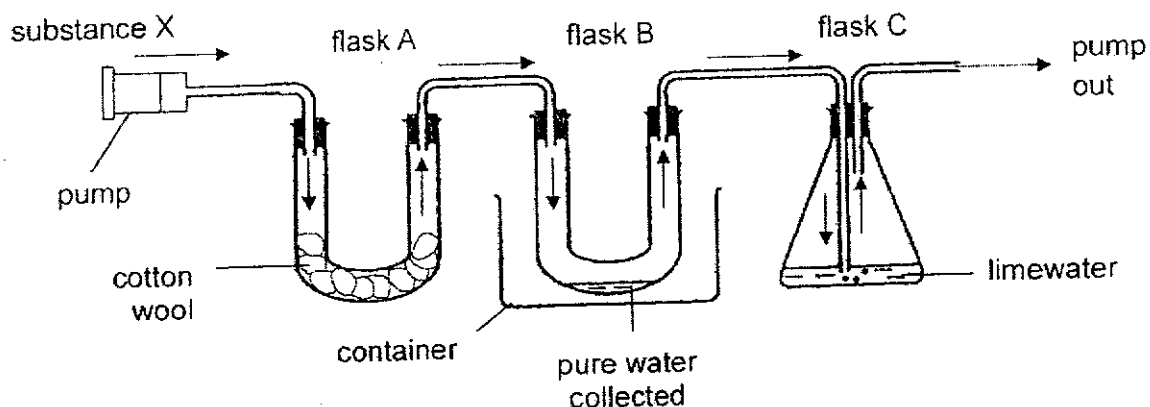

Flask A contains cotton wool which traps dirt from substance X. Substance X also contains water vapour and carbon dioxide.

- (a) Suggest how Jim can collect more pure water in flask B. Explain your answer. [2]

- (b) What would Jim observe in flask C to conclude that the substance X contains carbon dioxide? [1]

(Go on to the next page)

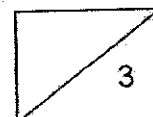

39. The diagram below shows two set-ups, A and B. The same amount of water has been poured into each of the funnels.

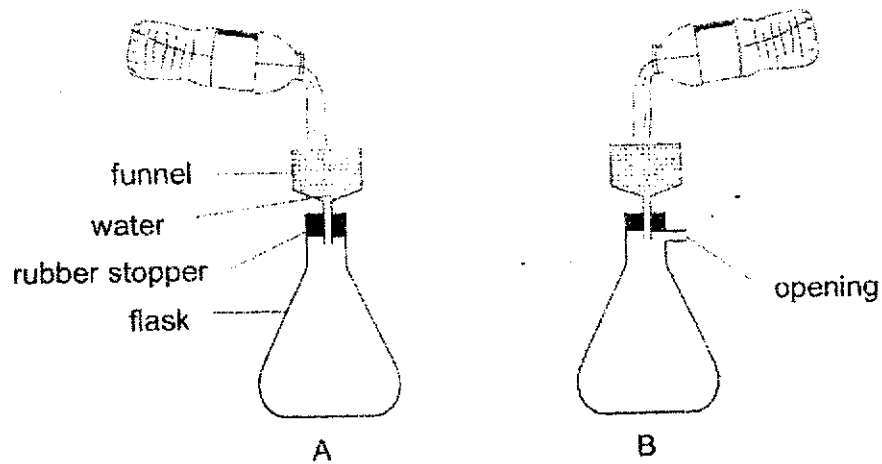

- (a) Compare the amount of water in the flasks for set-ups A and B after 5 minutes. [1]
-

Anya pushed the dispenser of a new bottle of hand sanitiser a few times before the sanitiser was dispensed into her hands.

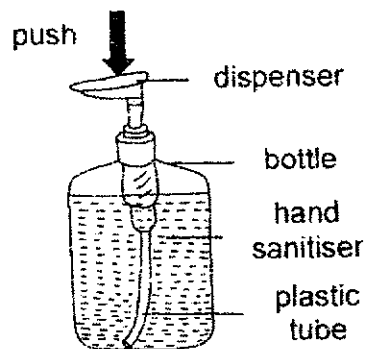

- (b) Explain why Anya had to push the dispenser a few times to dispense sanitiser from the bottle. [2]
-

(Go on to the next page)

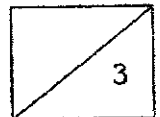

40. Mervin switched on the lamp to read the words on his book as seen in the diagram below.

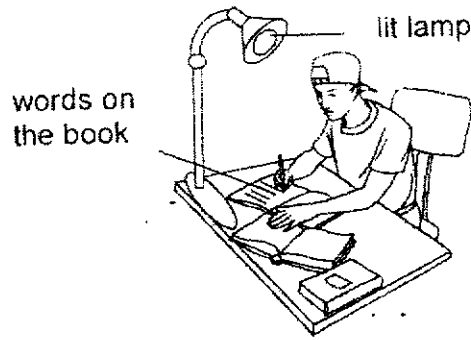

(a) Explain how Mervin was able to see the words on his book. [1]

Mervin was conducting research on two materials, J and K. He heated both materials and observed the change in length of the materials as shown in the graph below.

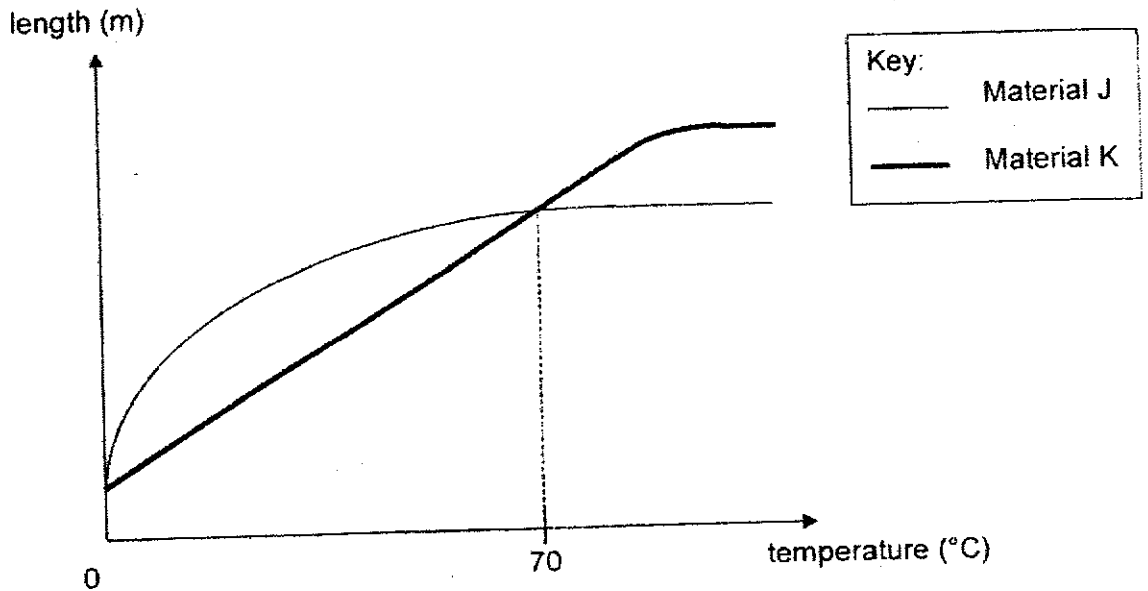

Question 40 continues on the next page.

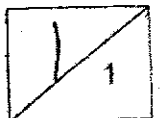

Question 40 continues.

The diagram below shows a disc that is fitted in a ring, preventing the disc from falling out of the ring. It is found in places with temperatures higher than 70°C.

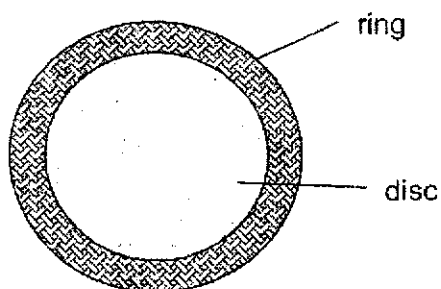

- (b) Based on the information above, which material, J or K, is suitable for making the ring? Explain your answer. [2]

(Go on to the next page)

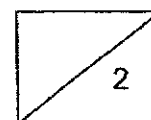

B-17

41. Naomi conducted an experiment as shown in the diagram below. She placed a magnet on Car A and different objects, W, X, Y and Z, on Car B at each round of the experiment. At the start of each round of the experiment, she held Cars A and B tightly at the 5 cm mark of the ruler.

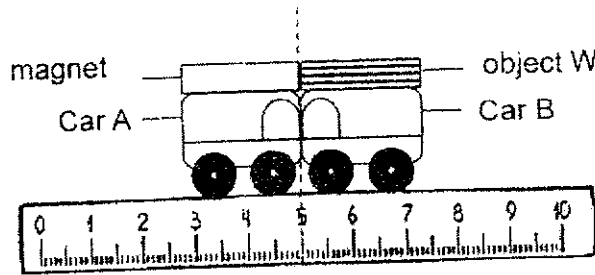

Next, she released both cars and measured the distance, h , between Cars A and B.

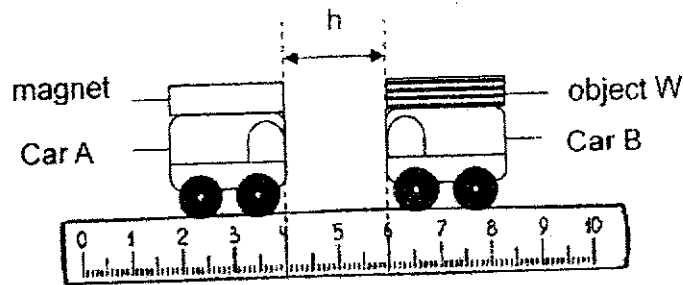

Naomi repeated the experiment with objects X, Y and Z. She recorded the results shown in the table below.

Object on Car B	W	X	Y	Z
h (cm)	2	0	7	0

(a) For each statement, write true or false in the table below. [1]

	Statement	True/False
(i)	W and Y are definitely magnets.	
(ii)	X and Z are definitely magnetic materials.	

(b) Using the information above, explain your answer in a(i). [1]

End of paper

B-18

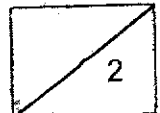

Primary 5 Science
End-of-Year Examination (Corrections)

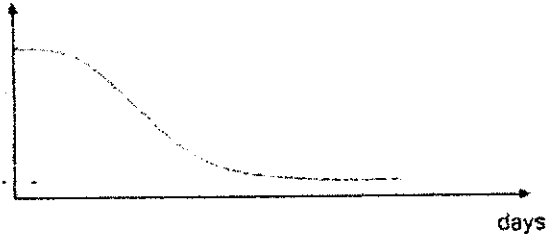
29a	The seed _____ water and _____ in size.
29b	<p>mass of seed leaf (g)</p>  <p style="text-align: right;">days</p>
30a	In the presence of _____ trapped by chlorophyll, _____ and _____ are converted to _____ and _____ in green plants.
30b	Food-carrying tubes at P and Q are removed. _____ made by the leaves of the _____ branch cannot be transported to below P and food made by the leaves of the _____ branch cannot be transported to above Q. Food is _____ at P and Q.
30c	_____-carrying tubes is not removed, so it can transport water to the _____. The leaves can continue to make food .
31a	Yes. It has a _____ which all plant cells have .
31b	It is where _____ take place.
31c	Cell _____. The cell _____ controls the _____ of substances entering in and _____ the cell, just like how object X _____ allows water to pass through .
32a	By spores.

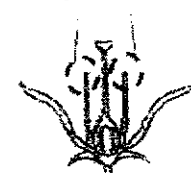
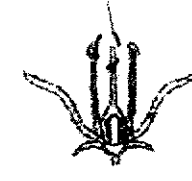
32b	<div style="display: flex; justify-content: space-around; align-items: center;"> <div style="text-align: center;"> <p>removed</p>  <p>Plant C</p> </div> <div style="text-align: center;"> <p>removed</p>  <p>Plant B</p> </div> </div>
32c	<p>Choice: Fruit _____ Data: Seeds of fruit _____ are _____. Explain: Hence, seeds of Fruit 2 will be _____ by the animals and _____ out as _____, so that they can be dispersed far away from the parent plant than Fruit 1.</p>
33a	<p>Pumps blood <u>around</u> the body.</p>
33b	<p>She can conclude that exercising increases pulse rate.</p>
33c	<p>Data: More blood flowed to Jon's muscles when he was exercising. Explain: During exercise, Jon need more energy. His heart pumps _____ faster to transport more oxygen and _____ food to all parts of the body faster.</p>
34a	<p>(i) Gullet (ii) Large Intestine</p>
34b	<p>Data: The flattened finger-like structure has _____ surface _____ than the finger-like structure. Explain: More digested food will be _____ into the bloodstream, causing him to lose weight.</p>
35a	<p>Rani should repeat her experiment to check for _____ in readings or find _____ readings.</p>

35b	<p>Choice: Material Q.</p> <p>Data: The maximum mass placed on Q is the _____. Explain: Hence, this proves that Q is the _____.</p>
36a	<ul style="list-style-type: none"> • As the distance of lamp from the water plant _____ from 35 cm to 15 cm, the rate of photosynthesis _____. • As distance of lamp from the water plant from 15 cm to 5 cm, the rate of photosynthesis remains the same.
36b	<p>Any one of the following:</p> <ul style="list-style-type: none"> - Increase the amount of carbon dioxide in the water - Use light with higher intensity - Add a snail into the water
36c	<p>To ensure that gas K is only produced by the plant through _____.</p>
36d	<p>It acts as a control set-up, so that he can compare and _____ that the results of the experiment is solely due to the _____ of light and not other variables.</p>
37a	<p>There is _____ exposed surface area of water, slowing down the rate of _____ of water.</p>
37b	<p>Any two of the following:</p> <ul style="list-style-type: none"> - Temperature of the surrounding air - Temperature of the water - Amount of wind - Presence of wind - Level of humidity

37c	<p>Water vapour in the surroundings loses heat to the ice-cream, _____ to form water droplets.</p> <p>The water droplets continued to _____ more heat to the ice-cream and freeze.</p>									
38a	<p>He can pour cold water/add ice in the container below flask B. The warmer water vapour loses heat faster to the cooler surface of flask B and condenses faster to form more water droplets.</p>									
38b	<p>The limewater will turn chalky in presence of carbon dioxide.</p>									
39a	<p>There will be more water in set-up B.</p>									
39b	<p>Air the plastic tube will _____ when the nozzle is pushed a few times causing the hand sanitiser to enter the plastic tube and occupy the _____ previously occupied by air.</p>									
40a	<p>The words on the book _____ light from the lamp into Mervin's eyes.</p>									
40b	<p>Choice: Material J. Data: Material J stopped _____ but K will continue to expand at temperature of 70°C or higher.</p>									
41a	<table border="1" style="width: 100%; border-collapse: collapse;"> <thead> <tr> <th style="width: 10%;"></th> <th style="width: 70%;">Statement</th> <th style="width: 20%;">True/False</th> </tr> </thead> <tbody> <tr> <td>(i)</td> <td>W and Y are definitely magnets.</td> <td>True</td> </tr> <tr> <td>(ii)</td> <td>X and Z are definitely magnetic materials.</td> <td>False</td> </tr> </tbody> </table>		Statement	True/False	(i)	W and Y are definitely magnets.	True	(ii)	X and Z are definitely magnetic materials.	False
	Statement	True/False								
(i)	W and Y are definitely magnets.	True								
(ii)	X and Z are definitely magnetic materials.	False								
41b	<p>W and Y repel the magnet and only magnets can repel other magnets.</p>									







SCHOOL : AI TONG PRIMARY SCHOOL
 LEVEL : PRIMARY 5
 SUBJECT : SCIENCE
 TERM : 2021 EOY

SECTION A

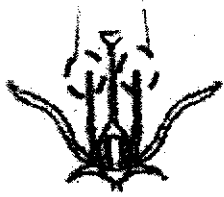
Q 1	Q2	Q3	Q4	Q5	Q6	Q7	Q8	Q9	Q10
2	2	1	3	1	3	2	4	2	2
Q 11	Q12	Q13	Q14	Q15	Q16	Q17	Q18	Q19	Q20
3	3	4	4	3	2	2	2	2	3
Q 21	Q22	Q23	Q24	Q25	Q26	Q27	Q28		
3	2	1	3	4	2	4	1		

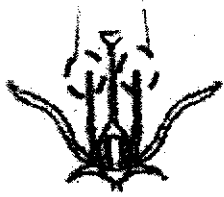
SECTION B

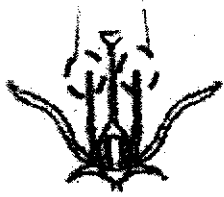
Q29a)	The seed absorbs water and grows in size.
Q29b)	<p>mass of seed leaf (g)</p>
Q30a)	In the presence of light trapped by chlorophyll, carbon dioxide and water are converted to food and oxygen in green plants.
Q30b)	Food-carrying tubes at P and Q are removed. Food made by the leaves of the upper branch cannot be transported to below P and food made by the leaves of the lower branch cannot be transported to above Q. food is accumulated at P and Q.

Q30c)	Water-carrying tubes is not removed, so it can transport water to the leaves. The leaves can continue to make food.						
Q31a)	Yes. It has a cell wall which all plant cells have.						
Q31b)	It is where cell activities take place.						
Q31c)	Cell membrane. The cell membrane controls the movement of substances entering in and out the cell, just like how object X only allows water to pass through.						
Q32a)	By spores.						
Q32b)	<table border="1" style="margin-left: auto; margin-right: auto;"> <tr> <td style="text-align: center;">removed</td> <td style="text-align: center;">removed</td> </tr> <tr> <td style="text-align: center;"></td> <td style="text-align: center;"></td> </tr> <tr> <td style="text-align: center;">Plant C</td> <td style="text-align: center;">Plant B</td> </tr> </table>	removed	removed			Plant C	Plant B
removed	removed						
							
Plant C	Plant B						
Q32c)	Fruit 2. Seeds of fruit 2 are small. Hence, seeds of fruit 2 will be swallowed by the animals and passed out as waste, so that they can be dispersed far away from the parent plant than fruit 1.						
Q33a)	Pumps blood around the body.						
Q33b)	She can conclude that exercising increases pulse rate.						
Q33c)	More blood flowed to Jon's muscles when he was exercising. During exercise, Jon needs more energy. His heart pumps blood faster to transport more oxygen and digested food to all parts of the body faster.						
Q34a)	(i) Gullet (ii) Large intestine						
Q34b)	The flattened finger-like structure has less exposed surface area than the finger-like structure. Less digested food will be absorbed into the bloodstream, causing him to lose weight.						
Q35a)	Rani should repeat her experiment to check for consistency in						

	readings or find average readings.
Q35b)	Material Q. the maximum mass placed on Q is the most. Hence, this proves that Q is the strongest.
Q36a)	As the distance of lamp from the water plant decreases from 35cm to 15cm, the rate of photosynthesis increases. As the distance of lamp from the water plant decreases from 15cm to 5cm, the rate of photosynthesis remains the same.
Q36b)	Any one of the following <ul style="list-style-type: none"> - Increase the amount of carbon dioxide in the water - Use light with higher intensity - Add a snail into the water
Q36c)	To ensure that has K collected is only produced by the plant through photosynthesis so that he can measure the amount of has K produced.
Q36d)	It acts as a control set-up, so that he can compare and conclude that the results of the experiment is solely due to the colour of light and not other variables.
Q37a)	There is less exposed surface area of water, slowing down the rate of evaporation of water.
Q37b)	Any two of the following <ul style="list-style-type: none"> - Temperature of the surrounding air - Temperature of the water - Amount of wind - Presence of wind - Level of humidity
Q37c)	Water vapour in the surroundings loses heat to the ice-cream, condenses to form water droplets. The water droplets continued to lose more heat to the ice-cream and freeze.
Q38a)	He can pour cold water/add ice in the container below flask B. the warmer water vapour loses heat faster to the cooler surface of flask B and condenses faster to form more water droplets.
Q38b)	The limewater will turn chalky in presence of carbon dioxide.
Q39a)	There will be more water in set-up B.
Q39b)	Air in the plastic tube will escape when the nozzle is pushed a few

	times causing the hand sanitiser to enter the plastic tube and occupy the space previously occupied by air.
Q40a)	The words on the book reflect light from the lamp into Mervin's eyes.
Q40b)	Material J. it stopped expanding but K will continue to expand at temperature of 70°C or higher.
Q41a)	(i) True (ii) False
Q41b)	W and Y repel the magnet and only magnets can repel other magnets.