



Rosyth School  
Second Semestral Assessment 2008  
Mathematics  
Primary 5

Name: \_\_\_\_\_

Class: Pr 5-\_\_\_\_\_ Register No. \_\_\_\_\_

Duration: 50 minutes

Date: 23 Oct 2008

Parent's Signature: \_\_\_\_\_

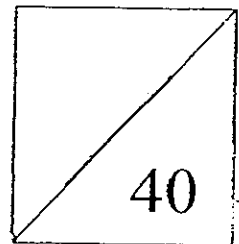

**PAPER 1 (BOOKLETS A & B)**

Instructions to Pupils:

1. Follow all instructions carefully.
2. Answer all questions.
3. For Questions 1 to 15, shade your answers in the Optical Answer Sheet(OAS) provided.
4. For questions 16 to 30, write your answers in this booklet.
5. You are **not** allowed to use a calculator.

Booklet	Total Marks	Marks
A	20 marks	
B	20 marks	
Paper 1 Total		

\*This paper consist of 11 pages altogether.

This paper is not to be reproduced in part or whole without the permission of the Principal.

**Booklet A**

Question 1 to 10 carry 1 mark each. Questions 11 to 15 carry 2 marks each. For each question, four options are given. One of them is the correct answer. Make your choice (1, 2, 3 and 4). Shade the correct answer on the OAS (Optical Answer Sheet)

(20 marks)

---

1) What is the value of the digit 6 in 3 067 090?

- (1) 60
- (2) 600
- (3) 6 000
- (4) -60 000

2) Find the value of  $500 + 16 \div 4 - 2$

- (1) 127
- (2) 258
- (3) 502
- (4) 508

3) What is the missing fraction in the box ?

$$\frac{1}{3} + \boxed{\phantom{00}} = \frac{5}{6}$$

- (1)  $\frac{1}{2}$
- (2)  $\frac{2}{3}$
- (3)  $\frac{4}{3}$
- (4)  $\frac{4}{6}$

4) What is the area of the shaded triangle?

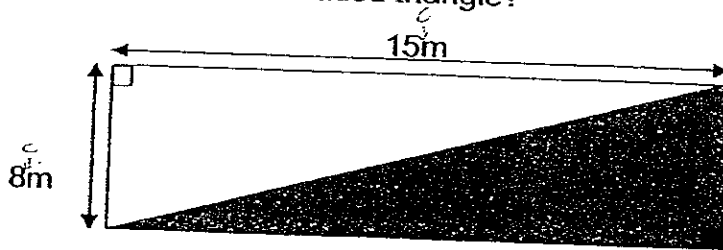

- (1) 24 cm<sup>2</sup>
- (2) 36 cm<sup>2</sup>
- (3) 60 cm<sup>2</sup>
- (4) 120 cm<sup>2</sup>

5) Which of the following has the same value as  $0.5 \times 9\,000$ ?

- (1)  $0.45 \times 100$
- (2)  $0.45 \times 1\,000$
- (3)  $4.5 \times 100$
- (4)  $4.5 \times 1\,000$

6) Express 75% as a fraction in its simplest form.

- (1)  $\frac{1}{75}$
- (2)  $\frac{1}{25}$
- (3)  $\frac{1}{4}$
- (4)  $\frac{3}{4}$

7) The heights of 3 boys are 1.3m, 1.4m and 1.5m. What is the average height of the boys?

- (1) 1.3m
- (2) 1.4 m
- (3) 1.5 m
- ~~(4) 4.2 m~~

8) In the figure below (not drawn to scale), find  $\angle x$ .

- (1)  $22^\circ$
- (2)  $68^\circ$
- (3)  $90^\circ$
- (4)  $94^\circ$

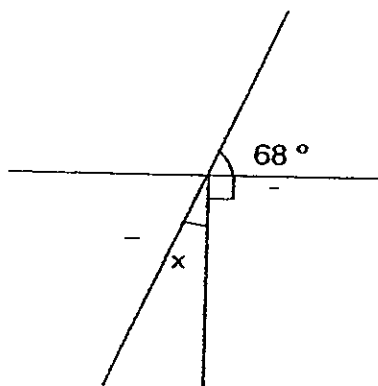

9) The figure below is not drawn to scale. Find the value of  $\angle XYZ$  in the isosceles triangle.

- (1)  $55^\circ$
- (2)  $60^\circ$
- (3)  $70^\circ$
- (4)  $110^\circ$

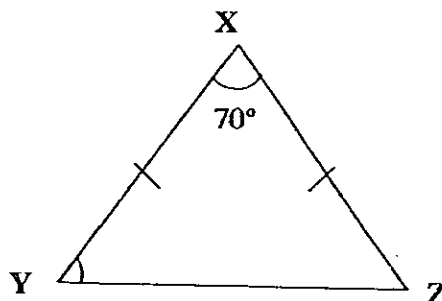

10) Which base corresponds to the height JP in the triangle below?

- (1) JK
- (2) JL
- (3) KL
- (4) OL

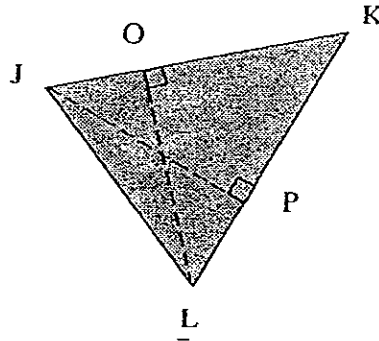

11) June divided a bag of beads among her friends. She gave  $\frac{1}{3}$  to Ken and  $\frac{1}{4}$  to Larry and kept 35 beads for herself. How many beads did June have at first?

- (1) 7
- (2) 35
- (3) 49
- (4) 84

12) Express 3 cm as a percentage of 150 cm

- (1) 0.02 %
- (2) 2 %
- (3) 3 %
- (4) 50%

13) The perimeter of a triangle is 28 cm. Its sides are in the ratio of 2 : 5 : 7. What is the length of the shortest side?

- (1) 2 cm
- (2) 4 cm
- (3) 10 cm
- (4) 14 cm

- 14) The figure below is made up of overlapping similar shapes. What fraction of the whole figure is shaded?

(1)  $\frac{3}{8}$

(2)  $\frac{1}{2}$

(3)  $\frac{5}{8}$

(4)  $\frac{3}{5}$

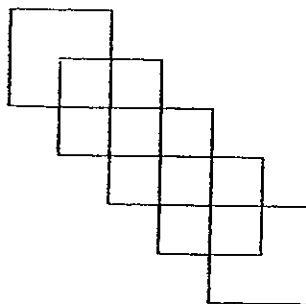

- 15) A container 100cm long, 30cm wide and 20cm high is  $\frac{1}{4}$  filled with water.  
- How much more water is needed to fill it to the brim?

(1) 15 000 ml

(2) 30 000 ml

(3) 45 000ml

(4) 60 000ml

**Booklet B**

Questions 16 to 25 carry 1 mark each. Write your answers in the spaces provided. For questions which require units, give your answers in the units stated. (10 marks)

---

16) What is the value of the digit 6 in 260 513?

Ans: \_\_\_\_\_

---

17) Find the value of  $4 - \frac{1}{5} - \frac{2}{3}$ .

Give your answer as a mixed number in its simplest form.

Ans: \_\_\_\_\_

---

18) A toy has a mass of 145 grams. What is the mass of this toy in kilograms?

Ans: \_\_\_\_\_ kg

---

19) Nicky saves an average of \$0.75 a day. How much can he save in 1 week?

Ans: \$ \_\_\_\_\_

---

20) Measure  $\angle ABC$ .

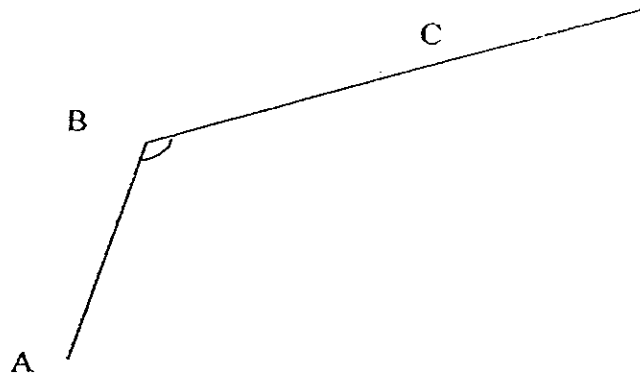

Ans: \_\_\_\_\_°

---

21) The figure below is not drawn to scale. WXYZ is a trapezium with WX parallel to YZ. Find  $\angle XYZ$ .

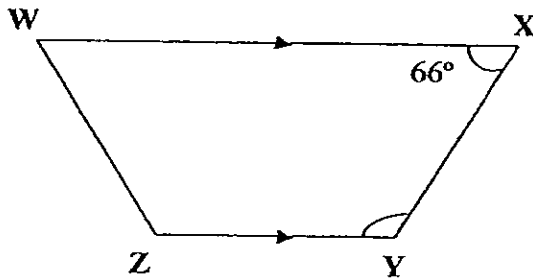

Ans: \_\_\_\_\_°

---

22) Round off 629 501 to the nearest thousand.

Ans: \_\_\_\_\_

---



23) The figure below is not drawn to scale. What is the area of triangle PQR?

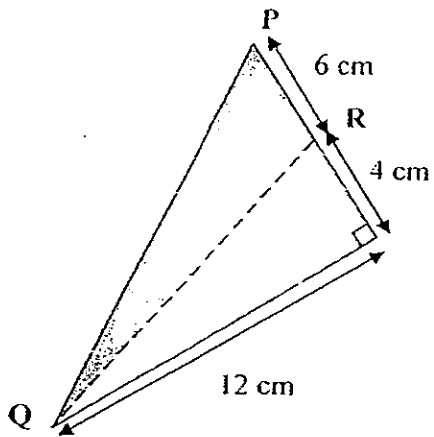

Ans: \_\_\_\_\_  $\text{cm}^2$

24) Express 8 km 36 m in kilometres.

Ans: \_\_\_\_\_ km

25) The figure is not drawn to scale. Find  $\angle a$ .

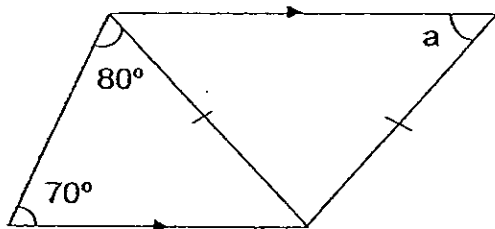

Ans: \_\_\_\_\_  $^\circ$

Questions 26 to 30 carry 2 marks each. **Show your working clearly** in the space below each question and write your answers in the spaces provided. For questions which require units, give your answers in the units stated. (10 marks)

---

- 26) A ribbon is cut into 2 pieces. The longer piece is twice as long as the shorter piece. What is the ratio of the longer piece of ribbon to the whole length of the ribbon?

Ans: \_\_\_\_\_

---

- 27) Mrs Goh uses the following recipe for fried rice.

**FRIED RICE (FOR 4 PEOPLE)**

4 cups of cooked rice  
8 onions  
2 teaspoons of butter  
1 carrot  
Half a packet of peas

How many onions does she need in order to make fried rice for 5 people?

Ans: \_\_\_\_\_

---

- 28) What is the maximum number of 4cm cubes that can be put into this box ?

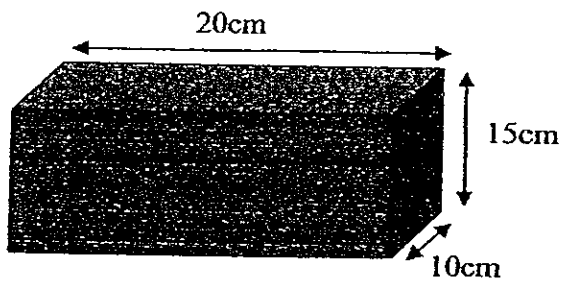

Ans: \_\_\_\_\_

- 29) David wants to buy a mobile phone which cost \$220 before a 10% discount. How much must he pay for the mobile phone after the discount?

Ans: \$ \_\_\_\_\_

- 30) Ben received his end of the year result slip but some ink was spilled on it. What could be his score for Mathematics?

Result slip for End of Year Examination	
Name: Benjamin Tan	
English	85
Mathematics	✻
Science	86
<b>Total</b>	<b>270</b>

Ans: \_\_\_\_\_



Rosyth School  
Second Semestral Assessment 2008  
Mathematics  
Primary 5

Name: \_\_\_\_\_

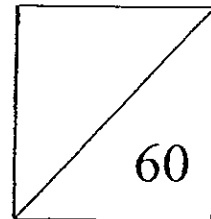

Class: Pr 5-\_\_\_\_\_ Register No. \_\_\_\_\_

Duration: 1h 40 minutes

Date: 23 Oct 2008

Parent's Signature: \_\_\_\_\_

---

---

## PAPER 2

### Instructions to Pupils:

1. Follow all instructions carefully.
2. Answer all questions.
3. Write your answers in this booklet.
4. Show your working clearly as marks are awarded for correct working.
5. You are allowed to use a calculator.

Questions	Total Marks	Marks
Q 1 to 5	10 marks	
Q 6 to 18	50 marks	
Paper 2 Total		

\*This paper consist of 13 pages altogether.



This paper is not to be reproduced in part or whole without the permission of the Principal.

Questions 1 to 5 carry 2 marks each. **Show your working clearly** in the space below each question and write your answers in the spaces provided. For questions which require units, give your answers in the units stated.

(10 marks)

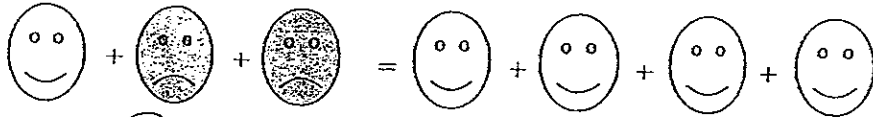
1)



If each  represents  $\frac{1}{2}$ , what does each  represent?

Ans: \_\_\_\_\_

2)

Mrs Tan bought  $\frac{1}{2}$  kg of flour. She used  $\frac{3}{4}$  of the flour to bake a cake. How much flour did she use?

Ans: \_\_\_\_\_ kg

3)

The figure below is not drawn to scale. NMOP is a rectangle.  $NX = XM$ . Find the total area of the shaded parts.

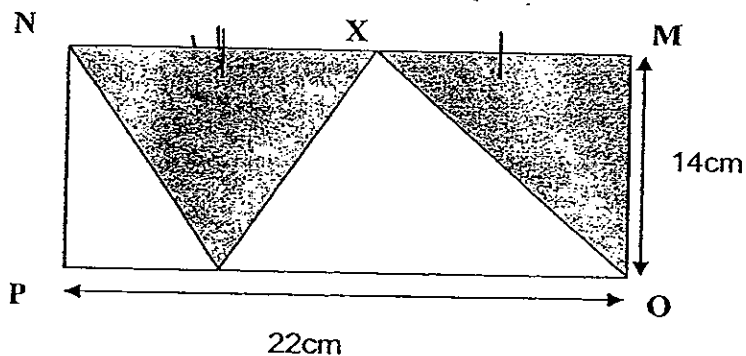

Ans: \_\_\_\_\_  $\text{cm}^2$

4) 3 water bottles cost \$22.50. How much will 7 water bottles cost?

Ans: \$ \_\_\_\_\_

5) Mr Phua had some triangular tiles with all sides 4 cm long. He placed them side by side to make a trapezium. The perimeter of the trapezium was 40 cm. How many tiles did Mr Phua use?

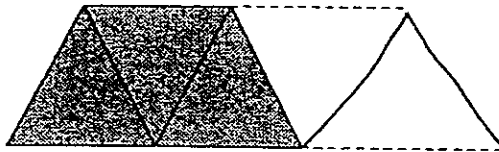

Ans: \_\_\_\_\_

For questions 6 to 18, **show your working clearly** in the space provided for each question and write your answers in the spaces provided.

The number of marks available is shown in brackets [ ] at the end of each question or part question. (50 marks)

---

- 6) Kelly had  $\frac{3}{5}$  as many jellybeans as Lynn. After Lynn gave Kelly  $\frac{3}{5}$  of her jellybeans, Kelly had 160 more than Lynn. How many jellybeans did they have altogether?

Ans: \_\_\_\_\_ [3]

---

- 7) Sue wrote all the numbers from 1 to 100 on a piece of paper.  
1, 2, 3, 4... 98, 99, 100.  
How many times did digit 4 appear ?

Ans: \_\_\_\_\_ [3]

---

- 8) A fish tank has 10 litres of water. Tommy turns on a tap to fill the tank with more water. Every 1 minute, 13 litres of water flow from the tap to the tank. What will be the volume of water in the tank after 15 minutes?

Ans: \_\_\_\_\_ [3]

- 9) The figure below is not drawn to scale. ABCD is a parallelogram.  $DA = DO$ . Find  $\angle ODB$ .

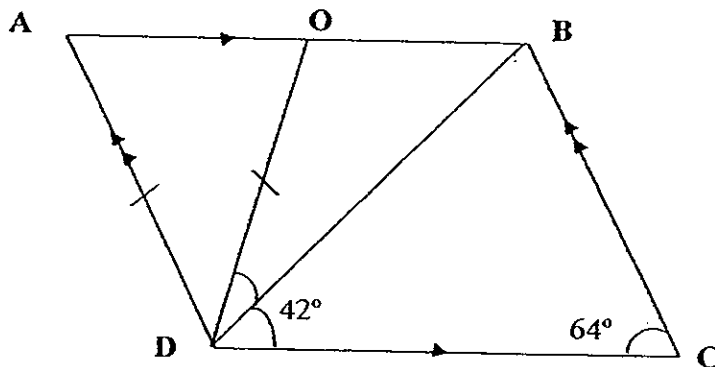

Ans: \_\_\_\_\_ [3]



- 10) Mr. Tan wants to fill a rectangular hole in his garden with cement. The hole is 4 m long, 3 m wide and 2 m deep. The cement costs \$86.50 per cubic metre. He has \$1 200. How much more money will he need to pay for the cement?

Ans: \_\_\_\_\_ [3]

---

- 11) Mr Raju had some \$2 notes and \$5 notes in his wallet. The number of \$2 notes is 3 times the number of \$5 notes. After he spent  $\frac{2}{3}$  of his \$2 notes, he had \$70 left in his wallet. How much did he spend?

Ans: \_\_\_\_\_ [4]

---

12) Mary is 30 years old. Nancy is 5 times as old as John. John is 16 years younger than Nancy.

(a) How old is Nancy?

(b) How old will Nancy be when Mary is 75 years old?

Ans: (a) \_\_\_\_\_ [2]

(b) \_\_\_\_\_ [2]

- 13) Roy paid \$206.25 for 5 English books and 9 Chinese books. If the cost of 4 English books is the same as 6 Chinese books, what is the cost of one English book?

Ans: \_\_\_\_\_ [4]

- 14) At an exhibition, 75% of the people were children. 60% of the children were girls. There were 375 adults. How many boys were at the exhibition?

Ans \_\_\_\_\_ [4]

- 15) John paid \$~~1440~~<sup>1920</sup> for 6 F1 Race tickets and 6 Singapore Flyer tickets. This costs ~~\$610~~<sup>\$390</sup> less than the cost of 8 F1 Race tickets and 3 Singapore Flyer tickets. What is the cost of 1 F1 Race ticket?

Ans: \_\_\_\_\_ [4]

- 16) 280 playing cards are shared among Ali, Bala and Charles in the ratio 6 : 3 : 1.
- (a) How many more cards does Ali have compared to Bala?
  - (b) How many more cards does Bala have compared to Charles?

Ans: (a) \_\_\_\_\_ [3]

(b) \_\_\_\_\_ [2]

- 17) (a) Draw a triangle XYZ such that  $XY = 6\text{cm}$ ,  $ZY = 6\text{cm}$  and  $\angle XYZ = 80^\circ$ .  
 Label the triangle XYZ and mark the  $80^\circ$  angle inside the triangle.
- (b) What do you call this type of triangle?
- (c) Find  $\angle ZXY$ .

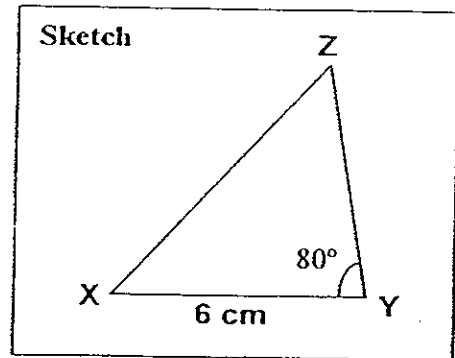

(a)

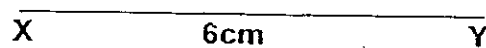

[3]

Ans: (b) \_\_\_\_\_ [1]

(c) \_\_\_\_\_ [1]

- 18) At first, Alice had 30% more beads than Betty. Carrie had 20% less beads than Alice. After Carrie received 480 more beads, she would have twice as many beads as Betty. How many beads did they have altogether at first?

Ans: \_\_\_\_\_ [5]

**~END OF PAPER~**  
*Have you checked your work thoroughly?*



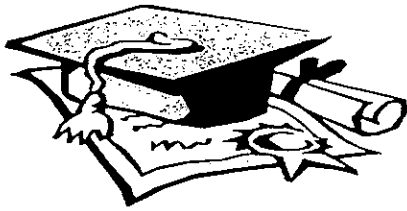

# ANSWER SHEET

EXAM PAPER 2008

SCHOOL : ROSYTH PRIMARY SCHOOL  
SUBJECT : PRIMARY 5 MATHEMATICS

TERM : SA 2

Q1	Q2	Q3	Q4	Q5	Q6	Q7	Q8	Q9	Q10	Q11	Q12	Q13	Q14	Q15
4	3	1	3	4	4	2	1	1	3	4	2	2	1	3

16) 60000

17)  $3\frac{2}{15}$

18) 0.145kg

19) \$5.25

20)  $125^\circ$

21)  $114^\circ$

22) 630000

23)  $36\text{cm}^2$

24) 8.036km

25)  $30^\circ$

26) 2:3

27) 10

28) 30

29) \$198

30) 99

## Paper 2

1)  $\frac{1}{2} \times 4 = 2$

$2 - \frac{1}{2} = 1\frac{1}{2}$

$1\frac{1}{2} \div 2 = \frac{3}{4}$

2)  $\frac{1}{2} \times \frac{3}{4} = \frac{3}{8}$

3)  $\frac{1}{2} \times 11 \times 14 = 77$

$77 \times 2 = 154\text{cm}^2$

4)  $22.50 \div 3 = 7.50$

$7.50 \times 7 = \$52.50$

5) 8

6)  $160 \div 4 = 40$

$40 \times 8 = 320$

7) 20

8)  $13 \times 15 = 195\text{L}$

$195 + 10 = 205\text{L}$

The volume is 205L

9)  $180 - 42 - 64 = 74$

$180 - 74 - 64 = 42$

$180 - 64 = 22^\circ$

10)  $4 \times 3 \times 2 = 24$

$86.50 \times 24 = 2076$

$2076 - 1200 = \$876$

11)  $2 + 5 = 7$

$70 \div 7 = 10$

$10 \rightarrow 10$

$2 \rightarrow 10 \times 2 = 20$

$20 \times 20 = 40$

12) a)  $16 \div 4 = 4$

$4 \times 5 = 20$

Nancy is 20 years old.

b)  $30 - 20 = 10$

$75 - 10 = 65$

Nancy would be 65 years old.

13)  $5 \times 4 = 20$

$9 \times 4 = 36$

$20 \div 4 = 5$

$5 \times 6 = 30$

$30 + 36 = 66$

$206.25 \times 4 = 825$

$825 \div 66 = 12.50$

$12.50 \times 9 = 112.50$

$206.25 - 112.50 = 93.75$

$93.75 \div 5 = 18.75$

The cost is \$18.75

14) 450

15)  $1920 + 390 = 2310$

$2310 \times 2 = 4620$

$4620 - 1920 = 2700$

$2700 \div 10 = 270$

The cost is \$270.

16) a)  $6 + 3 + 1 = 10$

$280 - 10 = 28$

$6 - 3 = 3$

$28 \times 3 = 84$

Ali have 84 more cards

b)  $3 - 1 = 2$

$2 \times 28 = 56$

Bala have 56 more

17) a)

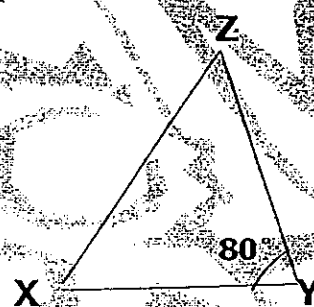

b) Isosceles

c)  $50^\circ$

18) 1670