

SINGAPORE CHINESE GIRLS' SCHOOL

FIRST SEMESTRAL ASSESSMENT 2009

PRIMARY 5

MATHEMATICS
PAPER 1

BOOKLET A

Name : _____ ()

Class : Primary 5 SY' CIG/SE/P

13 May 2009

		Marks attained	Max Mark
Paper 1	Booklet A		20
	Booklet B		20
Paper 2			60
Total Marks			100

Parent's Signature

15 Questions
20 Marks

Total Time for Booklets A and B: 50 min

INSTRUCTIONS TO CANDIDATES

Do not open this booklet until you are told to do so.

Follow all instructions carefully.

Answer all questions.

You are not allowed to use a calculator

Booklet A

Questions 1 to 10 carry 1 mark each. Questions 11 to 15 carry 2 marks each.
For each question, four options are given. One of them is the correct answer.
Make your choice (1, 2, 3 or 4). Shade the correct oval (1, 2, 3 or 4) on the Optical Answer Sheet.
(20 marks)

1 $200\,997 = \boxed{} + 900 + 97.$

What is the missing number in the box?

- (1) 200
- (2) 2 000
- (3) 20 000
- (4) 200 000

2 Six million, four hundred and twenty thousand and twenty is the same as _____.

- (1) 6 040 020
- (2) 6 042 020
- (3) 6 420 000
- (4) 6 420 020

3 The number of spectators at a stadium when rounded off to the nearest thousand is 69 000. Which of the following is most likely the actual number?

- (1) 68 499
- (2) 68 603
- (3) 69 560
- (4) 69 900

4 Which of the following fractions is less than $\frac{1}{2}$?

- (1) $\frac{4}{7}$
- (2) $\frac{5}{8}$
- (3) $\frac{6}{11}$
- (4) $\frac{7}{15}$

5 Which figure below does not have a line of symmetry?

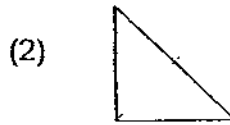

6 The sum of 14 tenths and 50 hundredths is _____.

- (1) 0.64
- (2) 0.19
- (3) 1.45
- (4) 1.90

7 The figure below is not drawn to scale. Which of the following lines is perpendicular to FB?

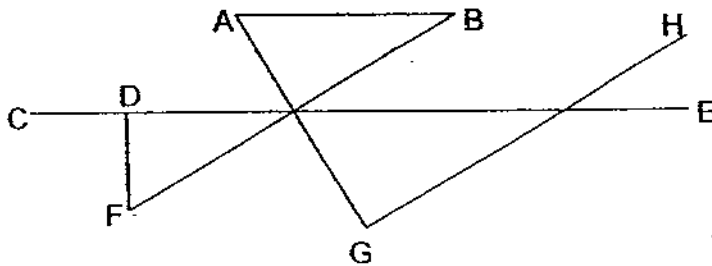

- (1) AG
- (2) CE
- (3) DF
- (4) GH

8 1 fruit bar has a mass of 0.05 kg. Find the total mass of 80 such fruit bars.

- (1) 40 g
- (2) 400 g
- (3) 4000 g
- (4) 40000 g

- 9 In the figure below, not drawn to scale, find its perimeter.

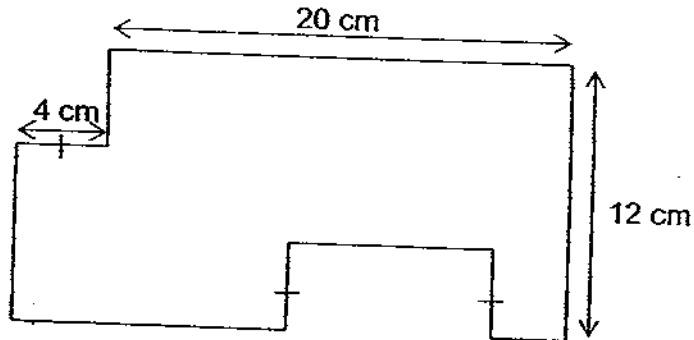

- (1) 36 cm
(2) 60 cm
(3) 72 cm
(4) 80 cm
- 10 The figure shows a rectangle, not drawn to scale. Find its shaded area.

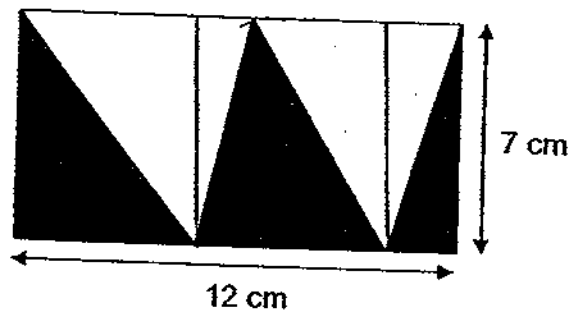

- (1) 28 cm^2
(2) 38 cm^2
(3) 42 cm^2
(4) 84 cm^2
- 11 4 girls shared a pizza equally for lunch. If one of them gave away $\frac{1}{3}$ of her share, what fraction of the pizza had she left?

- (1) $\frac{1}{12}$
(2) $\frac{1}{6}$
(3) $\frac{1}{4}$
(4) $\frac{2}{3}$

12 Jane and Alice shared 32 beads such that Jane received 4 more beads than Alice. Find the ratio of the number of Alice's beads to that of Jane's.

- (1) 9 : 7
- (2) 7 : 9
- (3) 5 : 4
- (4) 4 : 5

13 When $\frac{3}{8}$ of a number is increased by 18, the result is 54. What is the number?

- (1) 72
- (2) 96
- (3) 192
- (4) 288

14 Below is a number pattern.

2 , 5 , 11 , 23 , ?

What is the missing number?

- (1) 35
- (2) 37
- (3) 44
- (4) 47

15 The figure below is not drawn to scale. Find area of the shaded region.

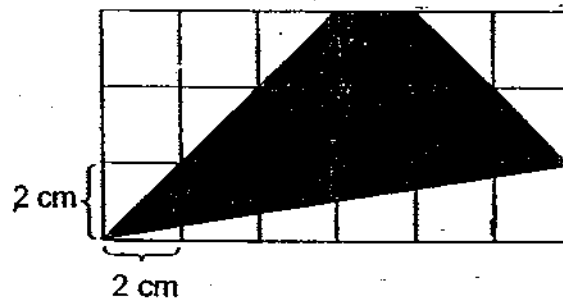

- (1) 18 cm²
- (2) 28 cm²
- (3) 34 cm²
- (4) 36 cm²

SINGAPORE CHINESE GIRLS' SCHOOL
FIRST SEMESTRAL ASSESSMENT 2009

PRIMARY 5

MATHEMATICS
PAPER 1

BOOKLET B

Name : _____ ()

Class : Primary 5 SY 2008/SE/P

13 May 2009

Paper 1	Mark attained	Max Mark
Booklet B		20

15 Questions
20 Marks

Total Time for Booklets A and B: 50 min

INSTRUCTIONS TO CANDIDATES

Do not open this booklet until you are told to do so.

Follow all instructions carefully.

Answer all questions.

You are not allowed to use a calculator

Booklet B

Name: _____ () Class: P5 CY C G/CE P

Questions 16 to 25 carry 1 mark each. Write your answers in the spaces provided. For questions which require units, give your answers in the units stated. (10 marks)

Do not write in this column

16 $8 \times 22 = 8 + 8 + 8 + 8 \times \boxed{?}$

What is the missing number in the box?

Ans: _____

17 How many times can $\frac{2}{5}$ be subtracted from 10?

Ans: _____

18 Express 40 km 32 m in kilometres.

Ans: _____ km

19 Simplify: $4\frac{1}{3} - 1\frac{3}{5}$

Ans: _____

20 A movie started at 7.50 p.m. If it lasted 145 minutes, at what time did it end?

Ans: _____ p.m.

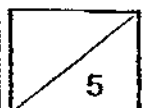

Do not write in this column

21 $7 : 3 = \boxed{?} : 27$

What is the missing number?

Ans: _____

22 The value of $18 + 36 \div (15 - 6) \times 4$ is _____

Ans: _____

23 Use all the digits below and form the **smallest** 6-digit even number. Do not start with the digit zero.

$4, 9, 3, 6, 0, 7$

Ans: _____

24 The figure below is not drawn to scale. Find the area of the shaded triangle.

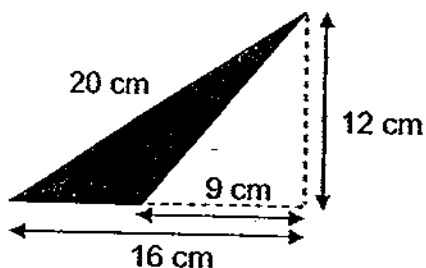

Ans: _____ cm^2

25 At first, Julie was standing at P, facing the East. She turned 225° clockwise and then 90° anticlockwise. Which direction was she facing then?

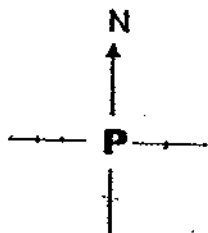

Ans: _____

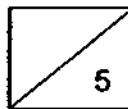

Questions 26 to 30 carry 2 marks each. Show your working clearly in the space for each question and write your answers in the spaces provided. For questions which require units, give your answers in the units stated.

Do not write
this column

(10 marks)

26 Alice is 10 yr 9 mth old now. How old will she be in $2\frac{1}{2}$ years' time?

Ans: _____ yr _____ mth

27 Linda had $\frac{5}{6}$ kg of grapes. Jane had $\frac{1}{2}$ of what Linda had. How much grapes did they have altogether? (Express your answer in its simplest form.)

Ans: _____ kg

28 How many **more** squares must be shaded so that the ratio of the number of unshaded squares to the number of shaded squares is 3 : 5?

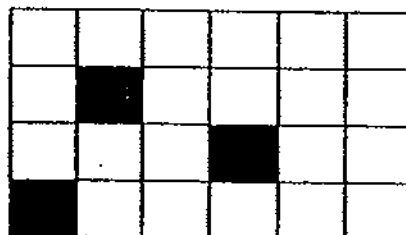

Ans: _____

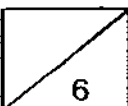

Do not write in
this column.

- 29 $\frac{1}{5}$ of the towels in a box are red, $\frac{3}{8}$ of the remainder are green and the rest are blue. Find the ratio of the number of blue towels to the number of green towels to the number of red towels. (Express your answer in its simplest form.)

Ans: _____

- 30 Study the number pattern carefully. What is the missing number?

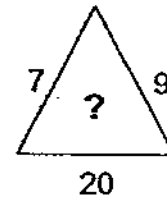
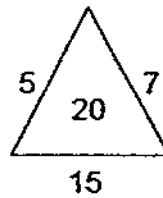
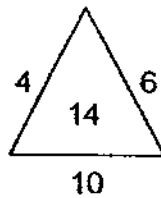
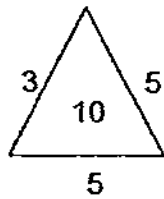

Ans: _____

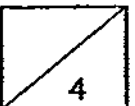

SINGAPORE CHINESE GIRLS' SCHOOL

FIRST SEMESTRAL ASSESSMENT 2009

PRIMARY 5

MATHEMATICS

PAPER 2

Name : _____ ()

13 May 2009

Class : Primary 5 SY/C/G/SE/P

	Mark	Max Mark
Paper 2		60

Parent's Signature

18 Questions
60 Marks

Total Time For Paper 2: 1 h 40 min

INSTRUCTIONS TO CANDIDATES

Do not open this booklet until you are told to do so.

Follow all instructions carefully.

Answer all questions.

Questions 1 to 5 carry 2 marks each. Show your working clearly in the space below each question and write your answers in the space provided. For questions which require units, give your answers in the units stated.

Do not write in this column

(10 marks)

- 1 Mrs Lim is 41 years old and her daughter is 14 years old. How many years ago was Mrs Lim four times as old as her daughter?

Ans: _____ yr

- 2 For every \$15 Sulin earns, she gives her mother \$3.50. How much does Sulin earn if her mother receives \$280?

Ans: \$ _____

3

Car For Hire	
First hour	\$45
Every additional $\frac{1}{2}$ hour or part thereof	\$19

Based on the above charges, how much did Bala pay for hiring a car for $8\frac{3}{4}$ hours?

Ans: \$ _____

6

- 4 Jim had 92 more marbles than Sam. After Sam gave Jim 18 marbles, Jim had twice as many marbles as Sam. How many marbles did Jim have at first?

Do not write in
this column

Ans: _____

- 5 In a school library, there are 3 Chinese Language books for every 5 English Language books. The number of Malay Language books is $\frac{5}{9}$ as many as the Chinese Language books. Find the ratio of the number of Malay Language books to the number of English Language books.
(Express your answer in its simplest form.)

Ans: _____

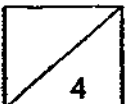

For questions 6 to 18, show your working clearly in the space below each question and write your answers in the spaces provided. The number of marks awarded is shown in brackets [] at the end of each question or part-question.

Do not write in this column

(50 marks)

- 6 96 identical bags of sugar are shared equally among 25 neighbours. If the mass of 6 bags of sugar is $3\frac{7}{8}$ kg, how much sugar does each neighbour receive? (Express your answer in kilogram.)

Ans: _____ [3]

- 7 At a party, Mrs Ong gave each pupil 5 nuggets and had 30 nuggets left. If she gave each pupil 6 nuggets, she would have 4 nuggets left. How many nuggets did Mrs Ong prepare for the party?

Ans: _____ [3]

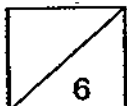

- 8 Mona wrote the numbers between 199 and 399. How many digit '0' were written between 199 and 399?

Do not write in
this column

Ans: _____ [3]

- 9 A rectangle has the same area as a square. The perimeter of the square is 48 cm. What is the length of the rectangle if its breadth is 8 cm?

Ans: _____ [3]

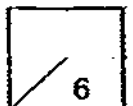

- 10 The graph below showed John's monthly expenses for six months in 2008. Study it carefully and then answer the questions.

Do not write
in this column

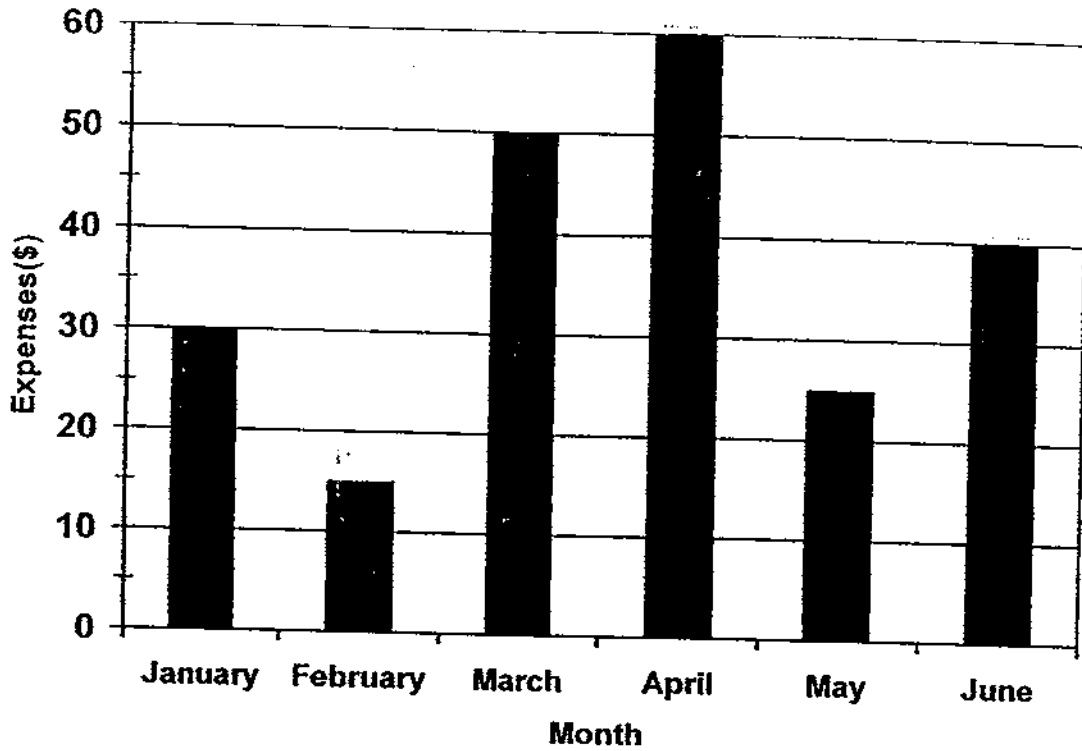

- (a) In which month did John save most of his allowance?
(b) If John's monthly allowance was \$90, find his total savings from January to March.

Ans: (a) _____ [1]

(b) _____ [2]

3

- 11 Kelly bought 3 similar gift packs for \$45. Each gift pack consisted of a file, a pen and a marker. Each file cost \$6 more than each pen. Each marker cost \$1.20 less than each pen. Find the cost of each file.

Do not write in
this column

Ans: _____ [4]

- 12 At Yummy Restaurant, each muffin cost $\frac{2}{5}$ as much as each hamburger.
Rita paid \$45.50 for 15 muffins and 7 hamburgers.

- (a) Find the cost of each muffin.
(b) Find the cost of each hamburger.

Ans:(a) _____ [3]

(b) _____ [1]

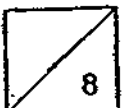

- 13 The figure below is not drawn to scale. Find the **shaded** area.

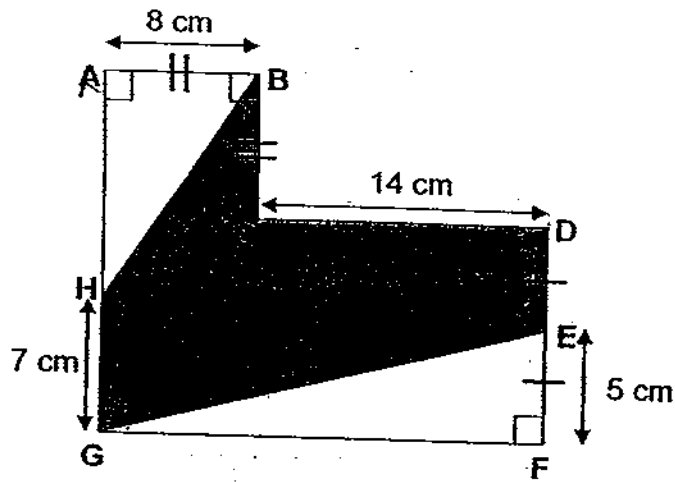

Do not write in this column

Ans: _____ [4]

- 14 Ken had three times as many apples as papayas. After selling 160 apples and 25 papayas, he had twice as many papayas as apples left. How many fruits did he have at first?

Ans: _____ [4]

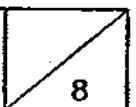

15 Tim spent \$1450 on a bicycle and $\frac{3}{7}$ of the remainder on a camera. He still had $\frac{1}{3}$ of his original savings left.

- (a) How much was his original amount of savings?
- (b) How much did he spend altogether?

Do not write in this column

Ans: (a) _____ [3]
(b) _____ [1]



16 Alan, Bill and Carl shared \$372. After Alan spent $\frac{2}{5}$ of his share, Bill spent $\frac{1}{2}$ of his share and Carl spent $\frac{1}{3}$ of his share, the boys found they had the same amount of money left.

Do not write in this column

- (a) What is the ratio of Alan's share to Bill's share to Carl's share?
(Express your answer in its simplest form.)
- (b) How much did they spend altogether?

Ans: (a) _____ [2]

(b) _____ [3]

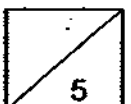

- 17 A coin box contained some twenty-cent and fifty-cent coins in the ratio 4 : 3. After 20 twenty-cent coins were taken out to exchange for fifty-cent coins of the same value and put back in the box, the ratio of the number of twenty-cent coins to the number of fifty-cent coins became 7:11. Find the sum of money in the box.

Do not write in this column

Ans: _____ [5]

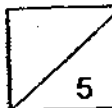

18 $\frac{3}{4}$ of the people at a swimming meet were swimmers. Of these swimmers, 324 were males and the remaining $\frac{2}{5}$ were females. There were 76 male non-swimmers.

- (a) How many people were there at the swimming ^{meet} pool?
- (b) What fraction of the people at the meet were female non-swimmers?
(Express your answer in its simplest form.)

Ans: (a) _____ [3]
(b) _____ [2]

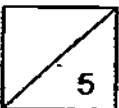

End of Paper
— CHECK YOUR WORK CAREFULLY —

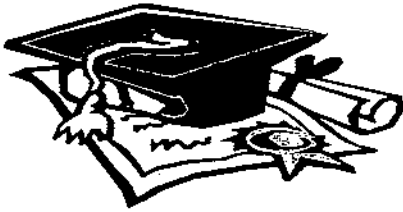

ANSWER SHEET

EXAM PAPER 2009

**SCHOOL : SCGS PRIMARY
SUBJECT : PRIMARY 5 MATHEMATICS**

TERM : SA1

Q1	Q2	Q3	Q4	Q5	Q6	Q7	Q8	Q9	Q10	Q11	Q12	Q13	Q14	Q15
4	4	2	4	1	4	1	3	4	3	2	2	2	4	3

- 16)19 17)25 times 18)40.032km 19) $2\frac{11}{15}$ 20)10.15p.m.
21)63 22)34 23)304796 24)42cm² 25)South-west
26)13 yr 3 mth 27) $1\frac{1}{4}$ kg 28)12 more squares
29)5:3:2 30)43

Paper 2

1)diff---- $41-14=27$ 3u-----27 1u----- $27\div 3=9$ Years ago---- $14-9=5$ yr	2)? Sets---- $\$280\div \$3.50=\$80$ Earn----- $80\times \$15=\1200
3)1 st hour→\$45 Next 1 hour→ $\$19\times 2=\38 Next 6 hour→ $\$38\times 6=\228 $\frac{3}{4}$ hour → $\$19\times 2=\38 Total → $\$45+\$38+\$228$ $+\$38=\349	4)1u→ $18+92+18=128$ Jim at first→ $128+18+92$ $=238$ marbles.

<p>5) $9u \rightarrow 3 \times 9 = 27$ Malay $\rightarrow 27 \times 5 / 9 = 15$ English $\rightarrow 5 \times 9 = 45$ M : E 15 : 45 1 : 3</p>	<p>6)? Set $\rightarrow 96 \div 6 = 16$ 16 set $\rightarrow 37/8 \text{kg} \times 16 = 62 \text{kg}$ Each neighbour $\rightarrow 62 \text{kg} \div 25 = 2.48 \text{kg}$</p>
<p>7) 160 nuggets</p>	<p>8) 40</p>
<p>9) Length of square $\rightarrow 48 \div 4 = 48 \text{cm}$ Area of square $\rightarrow 12 \text{cm} \times 12 \text{cm} = 144 \text{cm}^2$ Length $\rightarrow 144 \div 8 = 18 \text{cm}$</p>	<p>10) a) February b) <u>savings</u> January $\rightarrow \\$90 - \\$30 = \\$60$ February $\rightarrow \\$90 - \\$15 = \\$75$ March $\rightarrow \\$90 - \\$50 = \\$40$ Total $\rightarrow \\$60 + \\$75 + \\$40 = \\175</p>
<p>11) 1 gift pack $\rightarrow \\$45 \div 3 = \\15 3u $\rightarrow \\$15 - \\$6 - \\$1.20 - \\$1.20 = \\$6.60$ 1u $\rightarrow \\$6.60 \div 3 = \\2.20 1 file $\rightarrow \\$2.20 + \\$1.20 + \\$6 = \\9.40</p>	<p>12) a) 15 muffins $\rightarrow 15 \times 2 = 30 \text{units}$ 7 hamburgers $\rightarrow 7 \times 5 = 35 \text{u}$ Total $\rightarrow 30 + 35 = 65 \text{u}$ 65u $\rightarrow \\$45.50$ 1u $\rightarrow \\$45.50 \div 65 = \\0.70 1 muffin $\rightarrow \\$0.70 \times 2 = \\1.40 b) 1 hamburger $\rightarrow \\$0.70 \times 5 = \\3.50</p>
<p>13) Area of J $\rightarrow L \times B = 14 \text{cm} \times 8 \text{cm} = 112 \text{cm}^2$ Area of $\square \rightarrow L \times B = 22 \text{cm} \times 18 \text{cm} = 396 \text{cm}^2$ Area of figure $\rightarrow 396 \text{cm}^2 - 112 \text{cm}^2 = 284 \text{cm}^2$ Area of $\triangle k \rightarrow \frac{1}{2} \times B \times H = \frac{1}{2} \times 22 \times 5 = 55 \text{cm}^2$ Area of $\triangle L \rightarrow \frac{1}{2} \times B \times H = \frac{1}{2} \times 8 \times 11 = 44 \text{cm}^2$ Area of shaded $\rightarrow 284 \text{cm}^2 - 55 \text{cm}^2 - 44 \text{cm}^2 = 185 \text{cm}^2$</p>	<p>14) 1u $\rightarrow 2 \text{ small units} + 25$ 3u $\rightarrow 2 \times 3 = 6 \text{ small units} + 75$ 2u $\rightarrow 4 \text{ small units} + 50$ 5 small units $\rightarrow 135 - 50 = 85$ 1 small unit $\rightarrow 85 \div 5 = 17$ At first $\rightarrow (17 \times 2 + 25) + (17 + 160) = 59 + 177 = 236 \text{ fruits.}$</p>

<p>15)a) $5/12 \rightarrow \\$1450$ $1/12 \rightarrow \\$1450 \div 5 = \\290 Original amount $\rightarrow \\$290 \times 12 = \\3480 b) Spend $\rightarrow \\$1450 + \\$290 \times 3 = \\$2320$</p>	<p>16)a) $31u \rightarrow \\$372$ $1u \rightarrow \\$372 \div 31 = \\12 Alan $\rightarrow \\$12 \times 10 = \\120 Bill $\rightarrow \\$12 \times 12 = \\144 Carl $\rightarrow \\$12 \times 9 = \\108 Alan : Bill : Carl 120 : 144 : 108 60 : 72 : 54 30 : 36 : 27 10 : 12 : 9 b) $31u \rightarrow \\$372$ $1u \rightarrow \\$372 \div 31 = \\12 Spend $\rightarrow \\$12 \times 13 = \\156</p>
<p>17) \$27.60</p>	<p>18)a) $9/20 \rightarrow 324$ $1/20 \rightarrow 324 \div 9 = 36$ People $\rightarrow 36 \times 20 = 720$ b) non-swimmers $\rightarrow 720 \times 1/4 = 180$ Female non-swimmers $\rightarrow 180 - 76 = 104$ Fraction $\rightarrow 104/720 = 13/90$</p>

