



NAN HUA PRIMARY SCHOOL
CONTINUAL ASSESSMENT 2 – 2009
PRIMARY 5

MATHEMATICS

Paper 1

Section A: 15 Multiple Choice Questions (20 marks)

Section B: 15 Short Answer Questions (20 marks)

Total Time for Paper 1: 50 minutes

INSTRUCTION TO CANDIDATES

1. Write your name and index number in the space provided.
2. Do not turn over the page until you are told to do so.
3. Follow all instructions carefully.
4. Answer all questions.
5. Shade your answers in the Optical Answer Sheet (OAS) provided for Questions 1-15.
6. You are not allowed to use calculator for Paper 1.

Marks Obtained

Paper 1	Booklet A		/ 40
	Booklet B		
Paper 2			/ 60
Total			/ 100

Name : _____ ()

Class : 5 _____

Date : 25 AUG 2009

Parent's Signature : _

Section A (20 marks)

Questions 1 to 10 carry 1 mark each.

Questions 11 to 15 carry 2 marks each.

For each question, four options are given. One of them is the correct answer.

Make your choice (1, 2, 3 or 4) and shade on the oval (1, 2, 3 or 4) on the Optical Answer Sheet.

1. $8\,600\,000 = 860 \times \underline{\hspace{2cm}}$
What is the missing number in the blank?

- (1) 100
- (2) 1000
- (3) 10 000
- (4) 100 000

2. Find the value of $\frac{2}{5} + 4$.

- (1) $\frac{1}{10}$
- (2) $1\frac{2}{5}$
- (3) $\frac{5}{8}$
- (4) 10

3. What must be added to 0.444 to get 1?

- (1) 0.443
- (2) 0.556
- (3) 0.566
- (4) 1.444

4. Joshua and Elvis shared 60 apples in the ratio 2 : 3. How many more apples did Elvis have than Joshua?

- (1) 12
- (2) 20
- (3) 30
- (4) 55

5. The figure below shows a solid made up of 2-cm cubes. Find its volume.

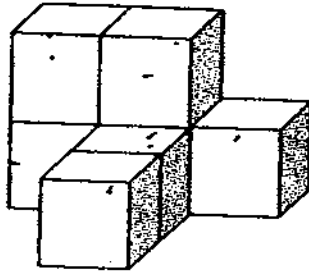

- (1) 7 cm^3
 - (2) 14 cm^3
 - (3) 28 cm^3
 - (4) 56 cm^3
6. Express the sum of $\frac{1}{5}$ and $\frac{1}{10}$ as a decimal.
- (1) 0.05
 - (2) 0.1
 - (3) 0.15
 - (4) 0.3

7. Express 0.635 as a percentage.

- (1) 0.635 %
- (2) 6.35 %
- (3) 63.5 %
- (4) 635 %

8. What fraction of the figure is not shaded?

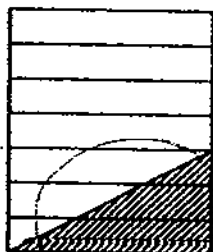

- (1) $\frac{3}{7}$
- (2) $\frac{4}{7}$
- (3) $\frac{3}{14}$
- (4) $\frac{11}{14}$

9. Evaluate $12 + 24 + 3 \times 2$.

- (1) 6
- (2) 24
- (3) 28
- (4) 40

10. $4 : 6 = \square : 39$

What is the missing value in the box?

- (1) 13
- (2) 24
- (3) 26
- (4) 52

11. Given that the figure below is not drawn to scale, what is the area of the shaded triangle ADE?

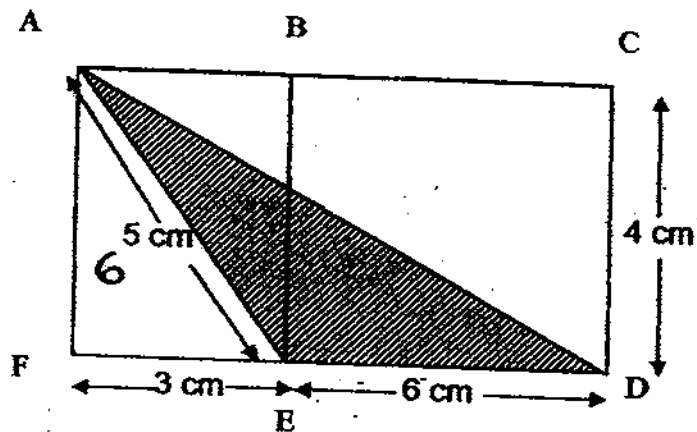

- (1) 7.5 cm^2
- (2) 10 cm^2
- (3) 12 cm^2
- (4) 15 cm^2

12. Javier's savings was $\frac{4}{7}$ of Ethan's. If he gave $\frac{1}{2}$ of his savings to Ethan, what fraction of Javier's savings was Ethan's?

(1) $\frac{1}{14}$

(2) $\frac{2}{9}$

(3) $\frac{2}{7}$

(4) $4\frac{1}{2}$

13. The chairs in a hall were arranged in rows. Each row had the same number of chairs. David and Sally sat side by side as shown in the diagram below. There were 7 chairs to his left and 4 chairs to her right. There were 7 chairs in front of him and 4 chairs behind her. How many chairs were there in the hall?

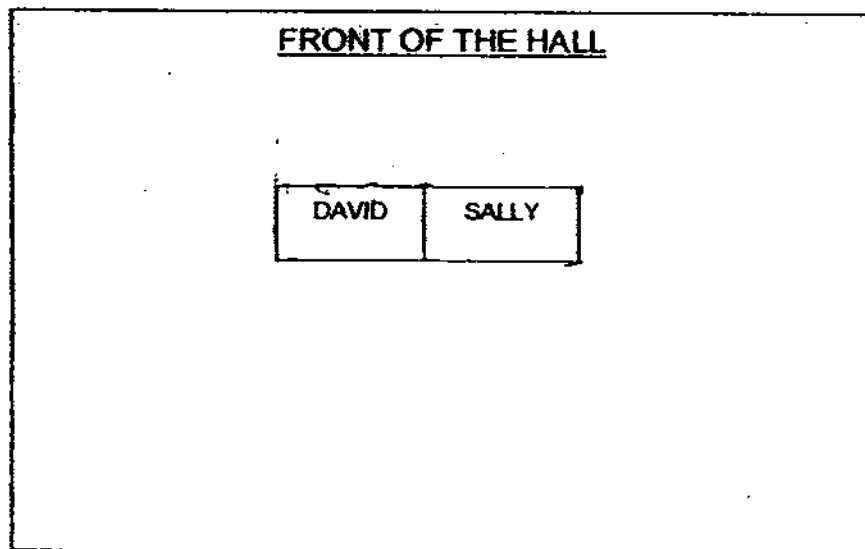

- (1) 24
(2) 121
(3) 123
(4) 156

14. The diagram below shows 4 different sets of shapes.

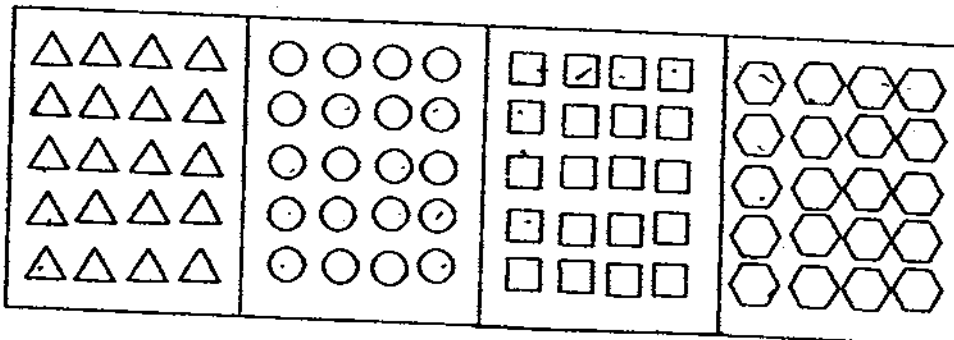

If 20 more circles are added, what percentage of the shapes are circles?

- (1) 40 %
 - (2) 50 %
 - (3) 60 %
 - (4) 80 %
15. A cube has a volume of 1000 cm^3 . Find the cost of painting all the surfaces of the cube with red paint at \$ 0.05 for every 1 cm^2 .
- (1) \$ 3.00
 - (2) \$ 30.00
 - (3) \$ 300.00
 - (4) \$ 3000.00

Questions 16 to 25 carry 1 mark each. Write your answers in the spaces provided. For questions which require units, give your answers in the units stated. Leave your answer in the simplest form.

[10 marks]

Do not write in this space

16. $95 + (95 \times 95) + 95 + (95 \times 95) = \underline{\hspace{2cm}} \times 95$

Ans : _____

17. What number has a remainder of 6 and a quotient of 142 when divided by 7?

Ans : _____

18. Look at the diagram below. Shade the figure such that $\frac{7}{9}$ of the figure are shaded.



19. Multiply 1.7 by 460.

Do not
write in this
space

Ans : _____

20. Natalie has $\frac{1}{2}$ as much money as Justina. Find the ratio of Justina's money to Natalie's money.

Ans : _____

21. The sum of the page numbers of two facing pages of a book is 135. What are the two page numbers?

Ans : Pages _____ and _____

22. Arrange the following numbers in descending order:

$\frac{3}{5}$, 2, $\frac{2}{9}$, $\frac{12}{7}$

Ans : _____

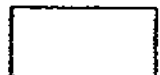

Do not
write in this
space

23. Find the area of figure ABCD which is formed by two triangles.

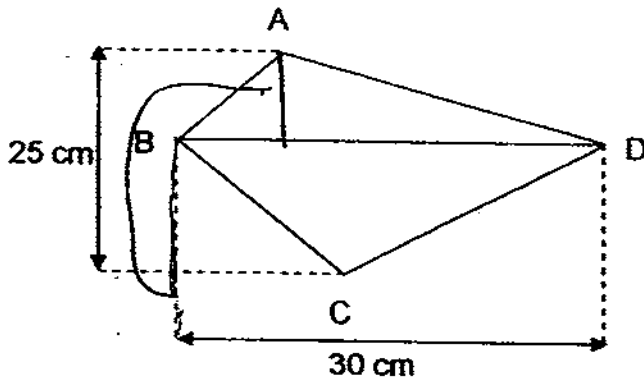

Ans: _____ cm²

24. If 0.8 of a number is 60, what is the number?

Ans : _____

25. $\frac{1}{3}$ of Adam's age is equal to $\frac{2}{5}$ of Eve's age. Find the ratio of Eve's age to Adam's age.

Ans : _____

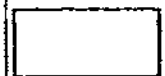

Questions 26 to 30 carry 2 marks each. Show your working clearly in the space provided for each question and write your answers in the spaces provided. For each questions which require units, give your answers in the units stated. [10 marks]

Do not write in this space

26. A shopkeeper gave away 2 sweets for every 5 boxes of chocolates bought. Each box of chocolates cost \$ 15. If Tom received 12 sweets, how much did he spend on the chocolates?

Ans : \$ _____

27. Goliath is $\frac{2}{7}$ of his father's age now. His father will be 46 years old in 4 years' time. In how many years' time will Goliath be $\frac{4}{9}$ of his father's age?

Ans: 1 _____

Ans: In _____ years'

28. Express 62.5 % as a fraction in the simplest form.

Do not
write in this
space

Ans : _____

29. There are 10 lamp posts along the street in front of Mrs Chew's house. The lamp posts are 5 m apart from each other. How far is the tenth lamp post from the second one?

Ans : _____ m

30. Find the sum of $1 + 3 + 5 + 7 + \dots + 99$.

Ans : _____

END OF PAPER



NAN HUA PRIMARY SCHOOL
CONTINUAL ASSESSMENT 2 – 2009
PRIMARY 5

MATHEMATICS

Paper 2

Total Time for Paper 2: 1 hour 40 minutes

5 Short Answer Questions (10 marks)

13 Structured / Long Answer Questions (50 marks)

INSTRUCTION TO CANDIDATES

1. Write your name and Index number in the space provided.
2. Do not turn over the page until you are told to do so.
3. Follow all instructions carefully
4. Answer all questions and show your workings clearly.
5. You are allowed to use a calculator.

Marks Obtained

Total		/ 60
-------	--	------

Name : _____ ()

Class : 5 _____

Date : 25 AUG 2009

Parent's Signature : _____

Questions 1 to 5 carry 2 marks each. Show your working clearly in the space provided for each question and write your answers in the spaces provided. For questions which require units, give your answers in the units stated. [10 marks]

Do not write in this space

1. For every \$2 saved by Kitty, her mother gave her another \$1. How much must Kitty save if she had \$252 *at the end*

Answer: \$ _____

2. The figure below is made by 2 overlapping Rectangles A and B. $\frac{5}{7}$ of Rectangle A and $\frac{8}{9}$ of Rectangle B is shaded. Express the shaded area of Rectangle A as a fraction of the total area of the figure.

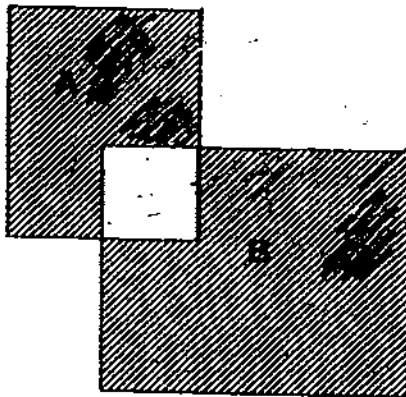

Answer: _____

Do not write
in this space

3. The charges for taking a taxi is shown below.
How much will Raynie have to pay for a journey of 2.5 km?

Distance travelled	Charges
First 1 km	\$ 2.50
Every additional 100 m or part thereof	\$ 0.20

Answer: \$ _____

4. The figure below is a square, ABCD. Given that AB is 6 cm and length of AE = DE, find the shaded area.

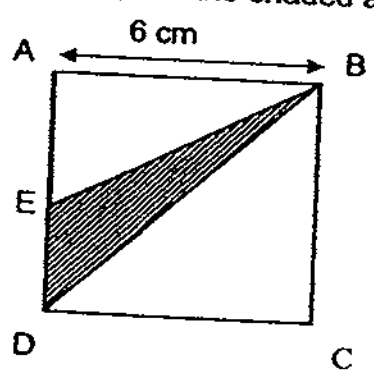

Answer: _____ cm²

5. The usual price of a plasma TV is \$ 9500. If there is a discount of 5 % , find the price of the plasma TV after the discount.

Do not write
in this space

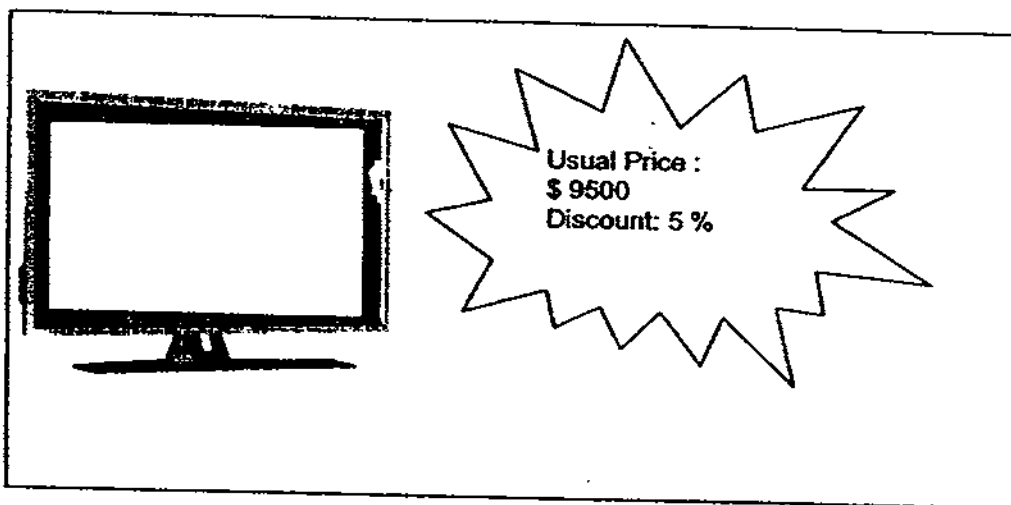

Answer: \$ _____

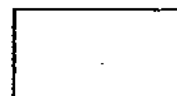

For questions 6 to 18, show your working clearly in the space provided for each question and write your answers in the spaces provided.

The number of marks available is shown in the brackets [] at the end of each question or part question.

[50 marks]

Do not write
in this space

6. Miss Tan wants to give some lollipops to her pupils. If she gives 4 lollipops to each pupil, she will have 20 lollipops left. If she gives 6 lollipops to each pupil, she will have 12 lollipops left. Given that Miss Tan has less than 40 lollipops, how many lollipops does Miss Tan have exactly?

Answer: _____ [3]

7. Jeremy used 760 g of sugar to bake cookies and $\frac{1}{9}$ of the remaining sugar to make cupcakes. ^{He} She then had $\frac{2}{7}$ of the sugar left. How much sugar was there at first?

Answer: _____ [3]

8. Mr Suresh bought 7 more files than books at a shop. Each file cost \$ 2.90 and each book cost \$ 7.20 more than a file. If the total cost of the items purchased was \$ 85.30, how many files did Mr Suresh buy?

Do not write
in this space

Answer: _____ [3]

9. Ali, Bryan and Cain had some stickers. Bryan and Cain together had 3 times as many stickers as Ali. The ratio of the number of stickers Bryan had to the number of stickers Cain had was 3:7. Ali and Cain had 310 stickers altogether. How many stickers did Ali have?

Answer: _____ [3]

10. A bag costs four times as much as a belt.
A pair of shoes costs \$ 12 less than a bag.
If each belt costs \$ 16, find the cost of 36 pairs of shoes.

Do not write
in this space

Answer: _____ [3]

11. The table below shows the time taken by 5 swimmers during a swimming competition. If the average time taken by the 5 swimmers is 42 s, find the time taken by Raj during the competition.

Swimmer	Time taken
Ah Beng	36 s
John	38 s
Tom	43 s
Raj	?
Shaun	41 s

Answer: _____ [3]

Do not write
in this space

12. Natasha bought 20 blouses and scarves for \$ 180.
She gave away 4 scarves.
Then she had the same number of blouses and scarves left.
Each blouse cost \$ 2 more than each scarf.

- (a) How many blouses did Natasha buy?
(b) How much did she pay for the blouses?

Answer.(a) _____ [1]

(b) _____ [3]

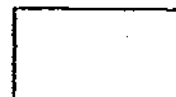

Do not write
in this space

13. Study the following sequence of patterns consisting of stars and circles.
The first three patterns are shown below.

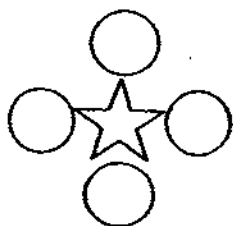

Pattern 1

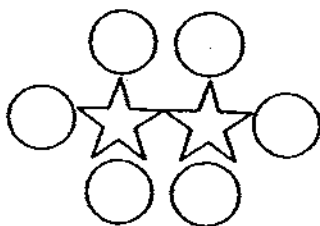

Pattern 2

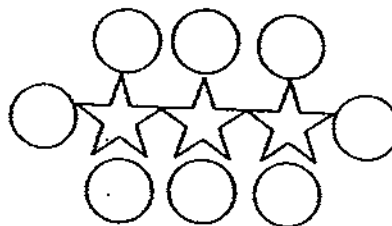

Pattern 3

a) Complete the table below.

Pattern	1	2	3	4	5	6	7
Number of stars	1	2	3	4	5	6	7
Number of circles	4	6		10	12		16

[1]

b) How many circles are there in the Pattern 16?

(b) _____ [1]

c) Find the number of stars in a pattern which has 50 circles.

(c) _____ [2]

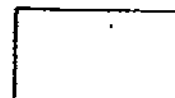

Do not write
in this spac

14.

Mr Frog fell into a well that was 840 cm deep on the first day. He climbed 200 cm up the well but slipped 50 cm down the slippery well.

On the second day, he climbed another 190 cm up the well but slipped 50 cm down again.

Each day, Mr Frog managed to climb 10 cm less than the day before.

However, each day, he slipped 50 cm down the slippery well.

On which day did Mr Frog get out of the well?

Answer. _____ [4]

Do not write
in this space

15. In 2007, $\frac{5}{7}$ of the members in a club were females.

In 2008, 8 male members joined the club and $\frac{3}{5}$ of the members were females.

- a) In 2007, how many more female than male members were there in the club?
- b) Find the total number of members in the club in 2008.

Answer: (a) _____ [3]

(b) _____ [2]

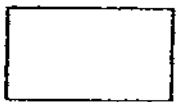

Do not write
in this space

16. Mr Tan has 14 l of water in a pail. He pours the water into an empty rectangular fish tank measuring 50 cm long, 40 cm wide and 40 cm high.
- (a) How much water is left in the pail after he has filled the tank with water to a depth of 5 cm?
- (b) If he pours the remaining amount of water in the pail equally into 5 identical bottles, how what is the volume of water in each bottle?

Answer: (a) _____ [3]

(b) _____ [2]



Do not write in this space

17.

The figure below shows a star formed by 5 identical isosceles triangles and a regular pentagon CEGIK (which is a 5-sided polygon with equal sides).
 Given that O is the centre of the star, length $OS = 11$ cm, and $KC = CE = EG = GI = IK = 12$ cm, find the area of the star.

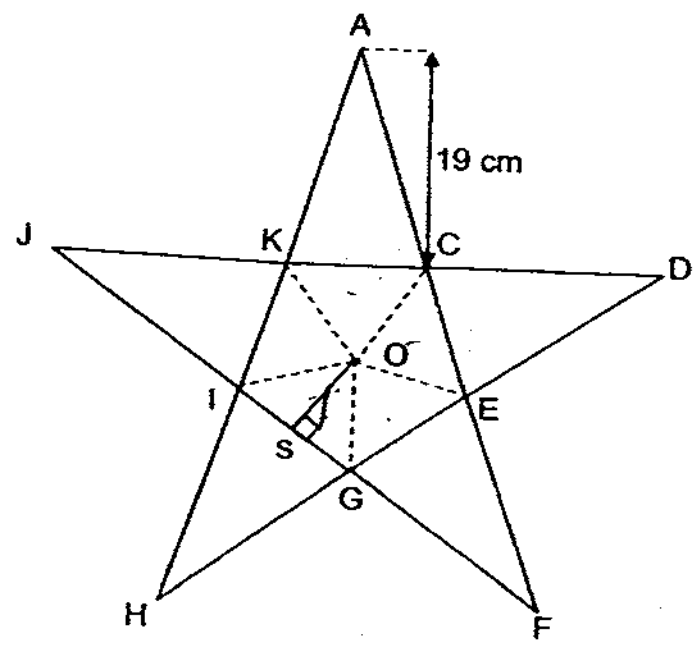

Answer: _____

Do not write
in this space

18. A bag has a total of 2712 red, green and blue marbles.
If 60% of the red marbles and 32 green marbles are given away and 20
more blue marbles are bought, there will be an equal number of the
three types of marbles.
How many of each type of marbles are there in the bag?

Answer: Red → _____

Blue → _____

Green → _____ [5]

END OF PAPER



ANSWER SHEET

EXAM PAPER 2009

**SCHOOL : NAN HUA PRIMARY
SUBJECT : PRIMARY 5 MATHEMATICS**

TERM : CA2

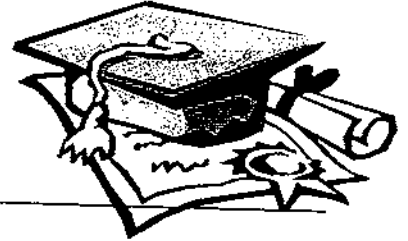

Q1	Q2	Q3	Q4	Q5	Q6	Q7	Q8	Q9	Q10	Q11	Q12	Q13	Q14	Q15
3	1	2	1	4	4	3	4	3	3	3	4	4	1	2

- 16)192 17)1000 18)

 19)782 20)2:1
- 21)67 and 68 22)2, 12/7, 3/5, 2/9 23)375cm² 24)75 25)5:6
- 26)\$450 27)12 years 28)5/8 29)40m 30)2500

Paper 2

1) $1+2=3$ $252 \div 3=84$ $84 \times 2=\$168$ She must save \$168	2) 5/23
3) $2500-1000=1500$ $0.20 \times 15=3$ $3+2.50=\$5.50$ Ha has to pay \$5.50	4) $6 \div 2=3$ $3 \times 6 \times \frac{1}{2} =9$ The shaded area is 9cm ²
5) $9500 \times 95/100=\$9025$ The price is \$9025	6) 36 lollipops
7) 1120g	8) $2.90 \times 7=20.30$ $85.30-20.30=65$ $2.90+7.20+2.90=13$ $65 \div 13=5$ $5+7=12$ He bought 12 files

<p>9) $21+10=31$ $310 \div 31=10$ $10 \times 10=100$ Ali had 100 stickers.</p>	<p>10) $16-12=4$ $16 \times 3=48$ $48+4=52$ $52 \times 36=\\$1872$ It cost \$1872</p>
<p>11) $42 \times 5=210$ $36+38+43+41=158$ $210-158=52$ Raj took 52s</p>	<p>12) $20-4=16$ $16 \div 2=8$ $8 \times 2=16$ $180-16=164$ $164 \div 20=8.20$ $8.20+2=10.20$ $10.20 \times 8=81.60$ a) She bought 8 blouses. b) She paid \$81.60</p>
<p>13) a) 8, 14 b) $16 \times 2=32$ $32+2=34$ There are 34 circles. c) $50-2=48$ $48 \div 2=24$ There are 24 stars.</p>	<p>14) 1) 150cm } 2) 140cm } 420 3) 130cm } 4) 120cm } 5) 110cm } 420 6) 100cm } 7) 90cm }</p> <p>$840-420=420$ $420-420=0$ On day 7 he got out Ans: Day 7</p>
<p>15) a) 18 more females b) 50 members</p>	<p>16) a) $50 \times 40 \times 5=10000$ $14000-10000=4000\text{ml}$ There is 4000ml left b) $4000 \div 5=800\text{ml}$ The volume is 800ml</p>
<p>17) $11 \times 12 \times \frac{1}{2}=66$ $66 \times 5=330$ $19 \times 12 \times \frac{1}{2}=114$ $114 \times 5=570$ $570+330=900$ The area is 900cm²</p>	<p>18) Red \rightarrow 1500 Blue \rightarrow 580 Green \rightarrow 632</p>