



NAN HUA PRIMARY SCHOOL
CONTINUAL ASSESSMENT 1 – 2017
PRIMARY 5

MATHEMATICS

Paper 1

Section A: 15 Multiple Choice Questions (20 marks)

Section B: 15 Short Answer Questions (25 marks)

Total Time for Paper 1: 1 h

INSTRUCTION TO CANDIDATES

1. Write your name and index number in the space provided.
2. Do not turn over the page until you are told to do so.
3. Follow all instructions carefully.
4. Answer all questions.
5. Shade your answers in the Optical Answer Sheet (OAS) provided for Questions 1-15.
6. You are not allowed to use calculator for Paper 1.

Marks Obtained

Paper 1	Booklet A		/ 45
	Booklet B		
Paper 2			/ 55
Total			/ 100

Name : _____ ()

Class : 5 _____

Date : 1st March 2017

Parent's Signature : _____

Section A (20 marks)

Questions 1 to 10 carry 1 mark each. Questions 11 to 15 carry 2 marks each.
For each question, four options are given. One of them is the correct answer.
Make your choice and shade your answer (1, 2, 3 or 4) on the Optical Answer Sheet.

1. What is the place value of the digit '9' in 293 405?

- (1) hundreds
- (2) thousands
- (3) ten thousands
- (4) hundred thousands

2. What is the product of 65 and 300?

- (1) 195
- (2) 1 950
- (3) 19 500
- (4) 195 000

3. How many thousands are there in one million?

- (1) 100
- (2) 1 000
- (3) 10 000
- (4) 100 000

4. Find the value of $93 - (36 + 18) + 3$.

- (1) 13
- (2) 25
- (3) 63
- (4) 75

5. Which of the following numbers are common factors of 12 and 18 ?

- (1) 6 and 9
- (2) 4 and 6
- (3) 3 and 6
- (4) 2 and 4

6. $7\frac{2}{5} = 7 + \square + \frac{1}{3}$

- (1) $\frac{1}{15}$
- (2) $\frac{1}{5}$
- (3) $\frac{3}{8}$
- (4) $\frac{1}{2}$

7. Which one of the following lines is perpendicular to XY?

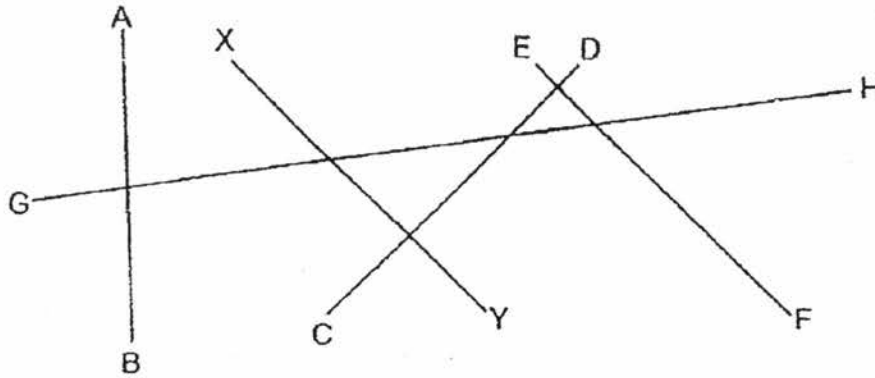

- (1) AB
- (2) CD
- (3) EF
- (4) GH

8. There were 14 blue pens and 6 red pens in a box. What fraction of the pens in the box were red pens?

- (1) $\frac{3}{10}$
- (2) $\frac{3}{7}$
- (3) $\frac{7}{10}$
- (4) $\frac{4}{7}$

9. How many ninths are there in $2\frac{1}{3}$?

- (1) 7
- (2) 9
- (3) 19
- (4) 21

10. In the diagram below, not drawn to scale, Mingfa was facing the basketball court. He turned 225° anti-clockwise. Where was he facing in the end?

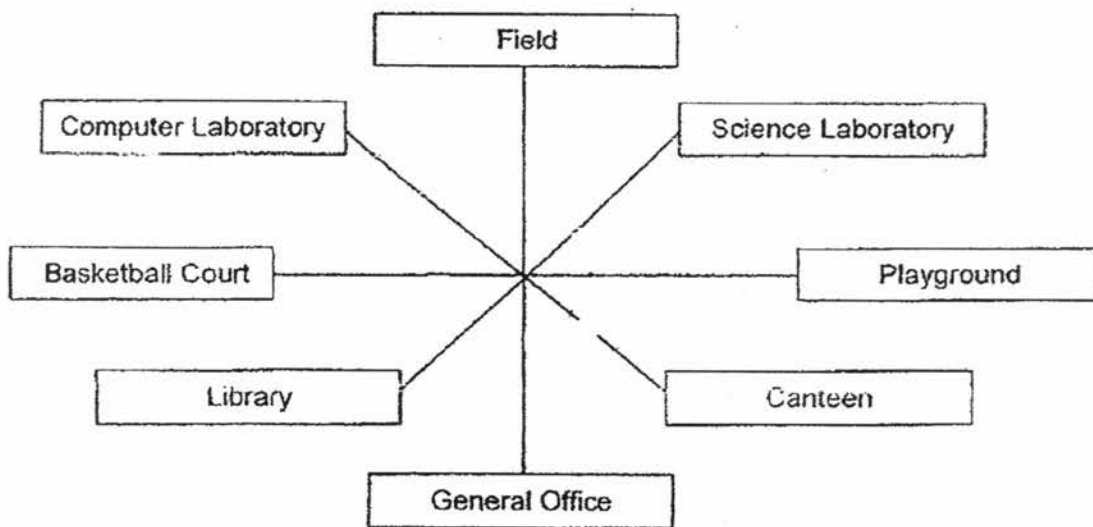

- (1) Library
- (2) Canteen
- (3) Science laboratory
- (4) Computer laboratory

11. What is the difference between $2\frac{2}{3}$ and $\frac{1}{4}$?

(1) $2\frac{5}{12}$

(2) $2\frac{1}{3}$

(3) $1\frac{5}{12}$

(4) $1\frac{1}{3}$

12. Study the diagram below.

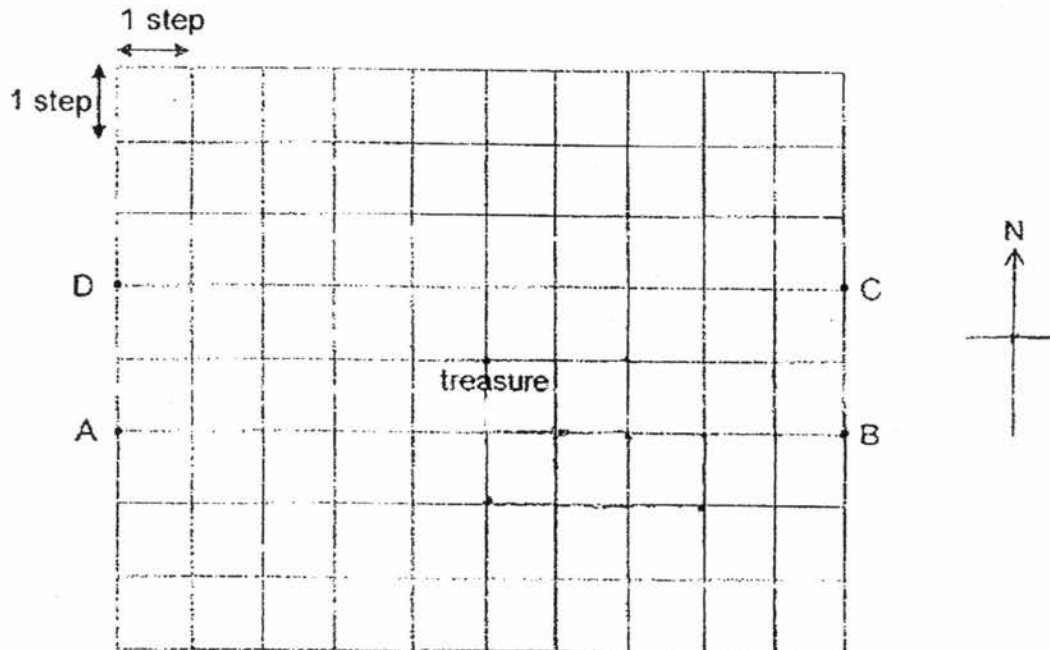

Marlene started at a position during a treasure hunt.

She walked 2 steps to the south, 3 steps to the west, 1 step to the north and 2 steps to the west again and spotted the hidden treasure.

What was her starting position?

(1) A

(2) B

(3) C

(4) D

- 13 The following line graph shows the number of books that Jaylyn read over 5 weeks during the December school holiday.

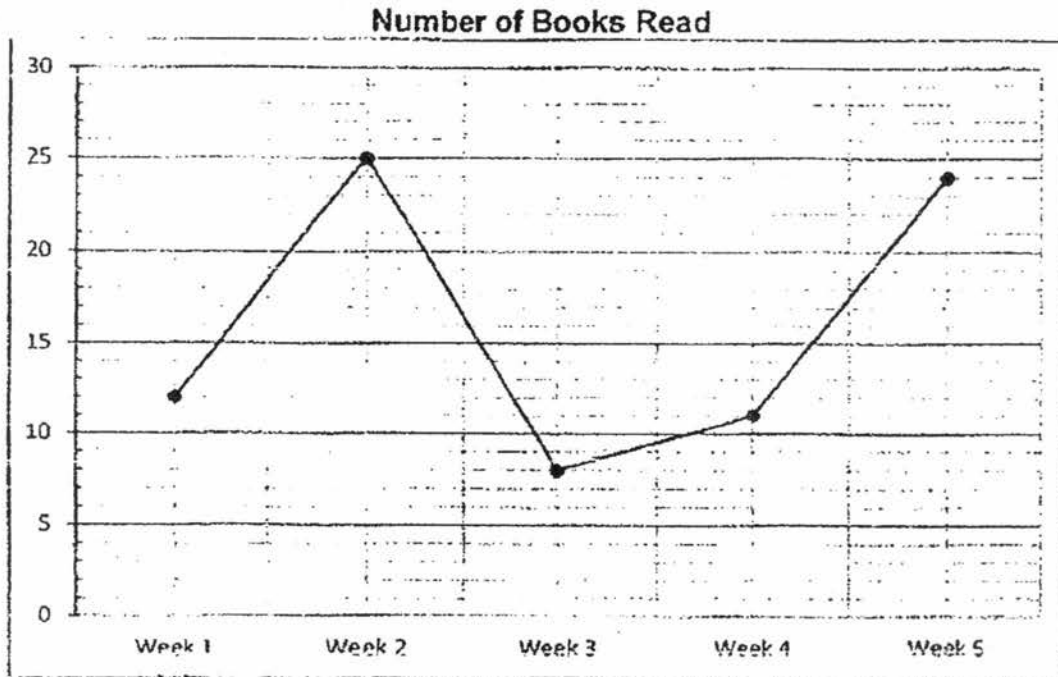

$\frac{5}{8}$ of the total number of books read by Jaylyn were Chinese books.

How many Chinese books did she read?

- (1) 16
- (2) 32
- (3) 48
- (4) 80

14. Josephine spent $\frac{1}{4}$ of her money on a pencil case and \$35 on a school bag.

She had $\frac{1}{3}$ of her money left. How much money did Josephine have at first?

- (1) \$28
- (2) \$42
- (3) \$56
- (4) \$84

15. In an auditorium, each row had the same number of seats. Mike sat on one of the seats in the auditorium. There were 4 seats on his left and 15 seats on his right. There were 10 rows behind him and 11 rows in front of him. How many seats were there in the auditorium altogether?

- (1) 399
- (2) 418
- (3) 420
- (4) 440

Section B (25 marks)

Do not write
in this space

Questions 16 to 20 carry 1 mark each. Write your answers in the spaces provided.
For questions which require units, give your answers in the units stated.

16. Write the following in numeral.

Three million, ninety-five thousand and eight.

Ans: _____

17. What is the value of 5 hundreds, 9 tenths and 2 thousandths?

Ans: _____

18. What is the value of A in the following number line?

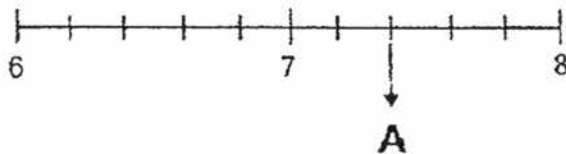

Ans: _____

19. What is the value of $29.55 \div 3$?

Ans: _____

20. Line AB is a line of symmetry. Shade the correct shapes in the grid below to make a symmetric pattern.

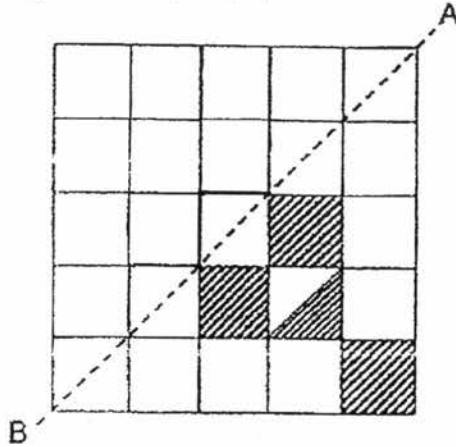

Do not write in this space.

Questions 21 to 30 carry 2 marks each. Show your working clearly in the space provided for each question and write your answers in the spaces provided. For questions which require units, give your answers in the units stated.

21. A container contains $2\frac{1}{2}$ ℓ of water. James pours in another $1\frac{3}{8}$ ℓ of water.
How much water is there in the container now?

Ans: _____ ℓ

22. $\frac{7}{10}$ of a number is 350. What is the number?

Ans: _____

23. Find the area of the following figure which is not drawn to scale.

Do not write in this space

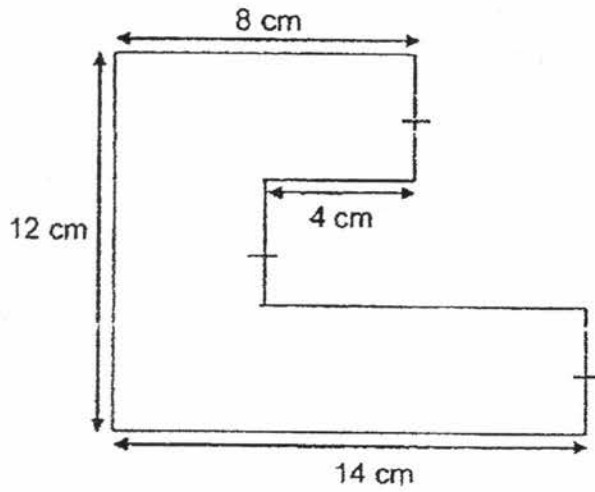

Ans: _____ cm²



24. There are 15 white and grey buttons. What fraction of the buttons are grey?
Express your answer in its simplest form.

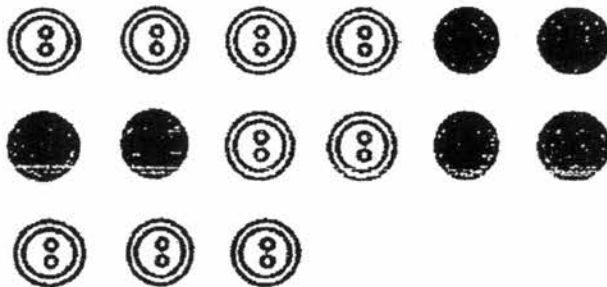

Ans: _____



Do not wr
in this spc

25. Pauline bought a box of 280 blue and yellow beads. $\frac{2}{7}$ of the beads were blue beads. How many yellow beads were there in the box?

Ans: _____

26. Mariah is 20 years old now. 2 years ago, her father was thrice her age. How old is her father now?

Ans: _____ years old

27. Samantha had two pieces of ribbons, A and B. Ribbon A was as long as Ribbon B. After Samantha used 86.8 cm of Ribbon A, the length of Ribbon B was 8 times as long as the length of Ribbon A left. What was the length of Ribbon B?

Ans: _____ cm

28. Miss Liew had a packet of sweets. When she packed the sweets into groups of 6, she had 3 sweets left. When she packed the sweets into groups of 8, she was short of 5 sweets. What was the minimum number of sweets that Miss Liew had?

Do not write
in this space

Ans: _____

29. In a bookshop, notebooks are sold at either \$0.70 each or \$6 for a set of 10 notebooks. What is the maximum number of notebooks that Xiuli can buy with \$20?

Ans: _____

Do not write
in this space

30. A group of pupils was given a bundle of identical red, blue and yellow ice-cream sticks. The length of an ice-cream stick was 10 cm. The pupils were instructed to place the ice-cream sticks one end touching the other, along the length of the classroom in the following pattern:

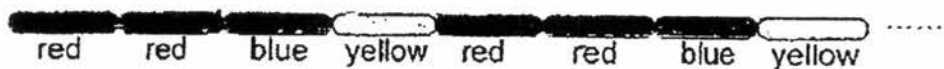

Given that the length of the classroom is 6 m 30 cm, find the total number of blue ice-cream sticks that the pupils used.

Ans: _____

END OF PAPER 1



NAN HUA PRIMARY SCHOOL
CONTINUAL ASSESSMENT 1 – 2017
PRIMARY 5

MATHEMATICS

Paper 2

Total Time for Paper 2: 1 hour 30 minutes

5 Short Answer Questions (10 marks)

12 Structured / Long Answer Questions (45 marks)

INSTRUCTION TO CANDIDATES

1. Write your name and index number in the space provided.
2. Do not turn over the page until you are told to do so.
3. Follow all instructions carefully
4. Answer all questions and show your workings clearly.
5. You are allowed to use a calculator.

Marks Obtained

Total		/ 55
-------	--	------

Name : _____ ()

Class : 5 _____

Date : 1st March 2017

Parent's Signature : _____

Paper 2 (55 marks)

Do not write in
this space

Questions 1 to 5 carry 2 marks each. Show your workings clearly and write your answer in the space provided. For questions which require units, give your answers in the units stated. (10 marks)

1. Jenson had 558 game cards. He lost 92 of them in a game and gave 105 game cards to his brother. How many game cards had he left?

Ans: _____

2. There are 39 535 books in the library.
Express the number to the nearest thousand.

Ans: _____

3. If 1 van can carry 9 passengers, what is the minimum number of vans needed to carry all 89 passengers?

Ans: _____

4. Mdm Chee baked 96 cupcakes. She sold $\frac{5}{6}$ of the cupcakes at \$2 each and the rest of the cupcakes at \$1 each. How much money did she collect altogether?

Do not write in this space

Ans: \$ _____

5. Write down all the factors of 12 .

Ans: _____

For questions 6 to 17, show your working clearly and write your answers in the spaces provided. The number of marks available is shown in brackets [] at the end of each question or part-question. (45 marks)

Do not write in this space

6. Fauziah had \$300. She paid \$56 for an iron and 3 times as much for a DVD player. How much did Fauziah have left?

Ans: \$ _____ [3]

7. There were an equal number of chocolates and sweets in a container. When 80 sweets were removed, there were 5 times as many chocolates as sweets left in the container. How many chocolates were there in the container?

Ans: _____ [3]

8. The cost of 2 books and 5 files was \$18. The cost of 6 books and 3 files was \$39.60. What was the total cost of 1 such book and 1 such file?

Do not write in
this space

Ans: \$ _____ [3]

9. Andrew had 4 times as many stamps as Brendon. Cathy had twice as many stamps as what Andrew and Brendon had altogether. She had 234 stamps more than Brendon. How many stamps did the three children have altogether?

Ans: _____ [3]

10. The figure below is made up of 2 identical rectangles and 4 identical squares. The area of the shaded part is 180 cm^2 . Find the perimeter of the figure. (The figure is not drawn to scale.)



Do not write in
this space

Ans: _____ [3]

11. Amanda had 4 times as much money as what Ben had. Amanda spent \$250 on food and another \$150 on transport. Then, she found that she now has twice as much money as Ben.
- How much did Amanda have at first ?
 - How much did Amanda and Ben have altogether at first ?

Ans: _____ [4]

12. Mr Lee bought a total of 106 balloons for his class of 41 pupils. He gave 3 balloons to every girl and 2 balloons to every boy. How many girls were there in his class?

Do not write in
this space

Ans: _____ [4]

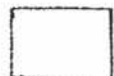

13. Study the following pattern.

Do not write in this space

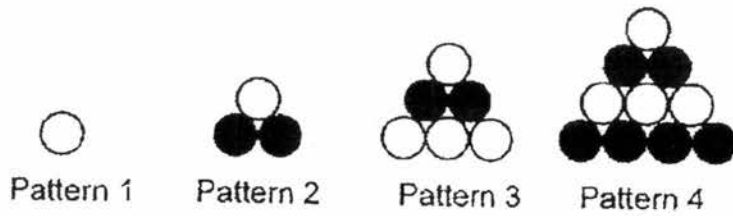

(a) Complete the table below.

Pattern Number	Number of white circles	Number of black circles	Total number of circles
1	1	0	1
2	1	2	3
3	4	2	6
4	4	6	10
.....
6	(i) _____	(ii) _____	21

(b) What is the number of black circles in Pattern 30?

Ans: (a) (i) _____ [1]

(ii) _____ [1]

(b) _____ [2]

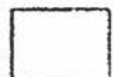

14. Some pupils were playing at different parts of the school $\frac{1}{4}$ of them were playing at the basketball court, $\frac{1}{8}$ of them were playing in the school field and the remaining 90 pupils were playing in the indoor sports hall.

- (a) How many pupils were there playing altogether?
(b) If there were 24 more girls than boys, how many boys were there?

Do not write in
this space

Ans: (a) _____ [2]

(b) _____ [2]

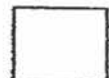

15. Siti spent a total of \$198 on some identical plates and bowls. She bought 2 more plates than bowls. Each plate cost \$3 and each bowl cost \$5. How many plates did Siti buy?

Do not write in
this space

Ans: _____ [4]

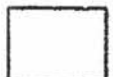

16. A fruiterer had the same number of apples, oranges and pears. After 177 apples, some oranges and pears were sold, there were 143 fruits left. The number of oranges sold was thrice as many as the number of pears sold. The number of oranges left was 12 more than the number of apples left. How many apples were there at first?

Do not write in this space

Ans: _____ [5]

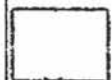

17. Bag Z had 32 marbles more than Bag Y and Bag Y had 14 marbles more than Bag X. The total number of marbles in Bags Y and Z was 8 times the number of marbles in Bag X.

(a) How many marbles should be moved from Bag Z to Bag Y so that these two bags would contain the same number of marbles?

(b) What was the total number of marbles in Bags X, Y and Z?

Do not write in
this space

Ans: (a) _____ [2]

(b) _____ [3]

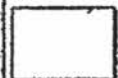

END OF PAPER 2

EXAM PAPER 2017 (P5)

SCHOOL : NAN HUA

SUBJECT : MATHEMATICS

TERM : CA1

Q1	Q2	Q3	Q4	Q5	Q6	Q7	Q8	Q9	Q10
3	3	2	4	3	1	2	1	4	3
Q11	Q12	Q13	Q14	Q15					
1	3	2	4	4					

16) 3095008

17) 500.902

18) $7\frac{2}{5}$

19) 9.85

20)

21) $3\frac{7}{8}L$

22) 500

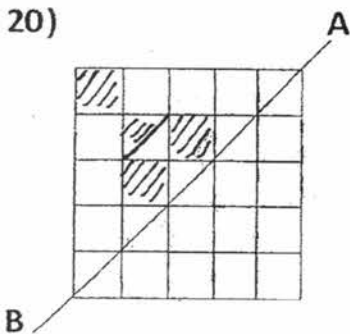

23) 104cm²

24) $\frac{2}{5}$

25) 200

26) 56 years old

27) 99.2cm

28) 27

29) 32

30) 16

Paper 2

1) $558 - 92 = 466$

$466 - 105 = 361$

2) $39535 \approx 40\ 000$

3) $89 \div 9 = 9\ R8$

$9 + 1 = 10$

4) $6u \rightarrow 96$

$1u \rightarrow 96 \div 6 = 16$

$16 \times 5 = 80$

$16 \times 1 = 16$

$160 + 16 = \$176$

5) $12 = 1 \times 12$

$2 \times 6 = 12$

$3 \times 4 = 12$

ANS: 1,2,3,4,6,12

6) $\$56 \times 3 = \168

$\$168 + \$56 = \$224$

$\$300 - \$224 = \$76$

7) $80 = 4u$

$1u = 80 \div 4 = 20$

$5u = 20 \times 5 = 100$

8) $2B + 5F = 18$

$6B + 8F = 39.60$

$8B + 8F = 18 + 39.60 = \$57.60$

$\$57.60 \div 8 = \7.20

9) $9u \rightarrow 234$

$1u \rightarrow 234 \div 9 = 26$

$15u = 26 \times 15 = 390$

10) 2 squares = 1 rect

$180 \div 5 = 36$

$36 = 6 \times 6$

$14 \times 6 = 84\text{cm}$

11) a) $2u \rightarrow 250 + 150 = 400$

$1u \rightarrow 400 \div 2 = 200$

$4u \rightarrow 200 \times 4 = \800

b) $5u \rightarrow 200 \times 5 = \1000

12)

No. of girls	No of balloons girl	No of boys	No of balloons (boys)	Total no of Balloons	Check X / \checkmark
20	$20 \times 3 = 60$	21	$21 \times 2 = 42$	$60 + 42 = 102$	X
21	$21 \times 3 = 63$	20	$20 \times 2 = 40$	$40 + 63 = 103$	X
22	$22 \times 3 = 66$	19	$19 \times 2 = 38$	$38 + 66 = 104$	X
23	$23 \times 3 = 69$	18	$18 \times 2 = 36$	$36 + 69 = 105$	X
24	$24 \times 3 = 72$	17	$17 \times 2 = 34$	$34 + 72 = 106$	\checkmark

ANS : 24

13)a)i) $4 + 5 = 9$ ii) $6 + 6 = 12$

b) $2+4+6+8+\dots\dots\dots+30 = 240$

14)a) $8u - 2u = 5u$

$5u = 90$

$1u = 90 \div 5 = 18$

$8u = 18 \times 8 = 144$

b) $144 - 24 = 120$

$120 \div 2 = 60$

15) $2 \times 3 = 6$

$198 - 6 = 192$

$3 + 5 = 8$

$192 \div 8 = 24$

$24 - 12 = 12$

16) $3u = 177 - 12 = 165$

$1u = 165 \div 3 = 55$

$4u = 55 \times 4 = 220$

$220 + 177 = 397$

$397 + 143 = 540$

$540 \div 3 = 180$

17)a) $32 \div 2 = 16$

b) $80 + 10 = 90$