



NAN HUA PRIMARY SCHOOL
CONTINUAL ASSESSMENT 1 – 2014
PRIMARY 5

MATHEMATICS

Paper 1

Section A: 15 Multiple Choice Questions (20 marks)

Section B: 15 Questions (20 marks)

Total Time for Paper 1: 50 minutes

INSTRUCTION TO CANDIDATES

1. Write your name and index number in the space provided.
2. Do not turn over the page until you are told to do so.
3. Follow all instructions carefully.
4. Answer all questions.
5. Shade your answers in the Optical Answer Sheet (OAS) provided for Questions 1-15.
6. You are not allowed to use the calculator for Paper 1.

Marks Obtained

Paper 1	/ 40
Paper 2	/ 60
Total	/ 100

Name : _____ ()

Class : _____

Date : 6 March 2014

Parent's Signature : _____

Section A (20 marks)

Questions 1 to 10 carry 1 mark each. Questions 11 to 15 carry 2 marks each. For each question, four options are given. One of them is the correct answer.

Make your choice (1, 2, 3 or 4) and shade on the oval (1, 2, 3 or 4) on the Optical Answer Sheet.

1. How many hundreds are there in 390 000?

- (1) 39
- (2) 390
- (3) 3 900
- (4) 39 000

2. Round off 67 823 to the nearest thousand.

- (1) 67 000
- (2) 67 800
- (3) 68 000
- (4) 68 800

3. What is the value of $128 + (36 - 12) \div 4 \times 2$?

- (1) 131
- (2) 140
- (3) 158
- (4) 268

4. 6 ones, 4 tenths and 9 thousandths is _____

- (1) 0.649
- (2) 6.049
- (3) 6.409
- (4) 6.490

5. Find the value of $\frac{3}{5} + \frac{1}{4}$.

- (1) $\frac{3}{20}$
- (2) $\frac{4}{20}$
- (3) $\frac{4}{9}$
- (4) $\frac{17}{20}$

6. Rectangle PQRS below is divided into 20 equal squares. How many more squares must be shaded so that $\frac{3}{4}$ of rectangle PQRS is shaded?

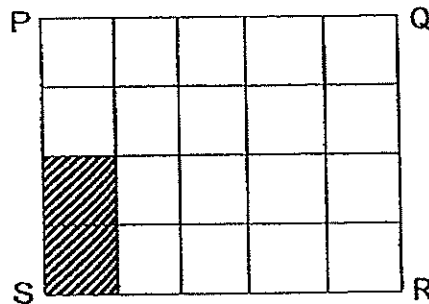

- (1) 12
- (2) 13
- (3) 14
- (4) 15

7. Express $5\frac{3}{4}$ as a decimal.

(1) 5.25

(2) 5.34

(3) 5.43

(4) 5.75

8. How many ninths are there in $2\frac{2}{3}$?

(1) 6

(2) 8

(3) 24

(4) 72

9. 23 056 m = _____ km

(1) 2.3056

(2) 23.056

(3) 230.56

(4) 2305.6

10. Mr Lim bought a television set. He paid \$75 each month for 20 months. If he still had \$300 left to pay, how much did the television set cost?

(1) \$1 200

(2) \$1 500

(3) \$1 800

(4) \$2 100

11. Mrs Koh gave $\frac{3}{8}$ of her pineapple tarts to her sister and $\frac{1}{2}$ of the remaining to her mother. What fraction of the pineapple tarts had she left?

(1) $\frac{3}{16}$

(2) $\frac{5}{16}$

(3) $\frac{9}{16}$

(4) $\frac{11}{16}$

12. The line graph below shows the number of pupils coming to school using different modes of transport.

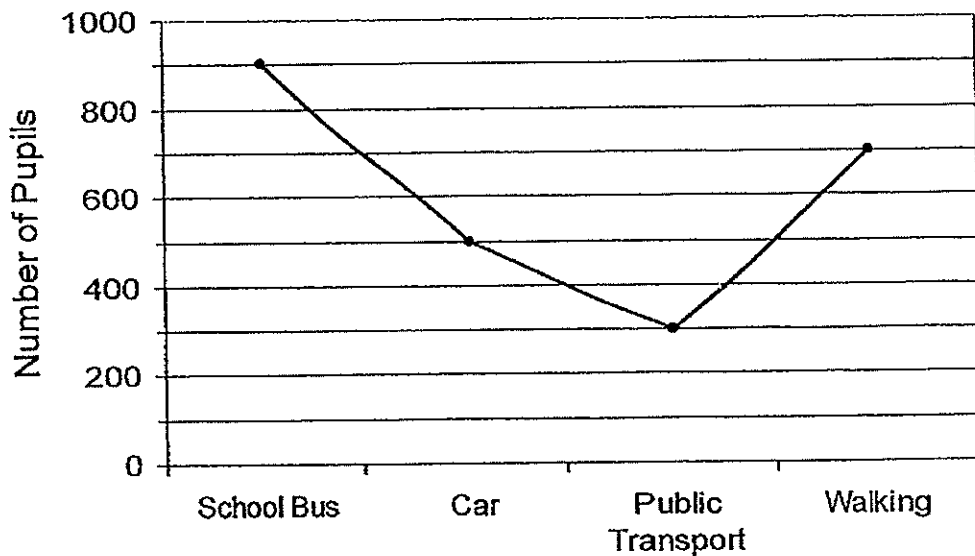

How many pupils travel to school by school bus and walking?

(1) 1 600

(2) 1 400

(3) 1 200

(4) 1 000

13. $\frac{1}{4}$ of the beads in a box are blue. $\frac{1}{3}$ of the blue beads are small. If there are 700 small blue beads, how many beads are there altogether in the box?

- (1) 1 200
- (2) 2 450
- (3) 4 900
- (4) 8 400

14. Heidi is 41 years old and her son is 17 years old now. How many years ago was she 3 times as old as her son?

- (1) 5
- (2) 7
- (3) 3
- (4) 9

15. A rectangle ABCD is divided into 6 equal parts. The total area of the shaded parts is 12 cm^2 . Both the length and breadth of rectangle ABCD are even whole numbers. What is the perimeter of rectangle ABCD?



- (1) 26 cm
- (2) 36 cm
- (3) 40 cm
- (4) 74 cm

Section B (20 marks)

Questions 16 to 25 carry 1 mark each. Questions 26 to 30 carry 2 marks each.
For each question from 26 to 30, show your workings clearly in the space below it and write your answer in the space provided. Give your answers in the units stated.

16. Write 350 094 in words.

Ans: _____

17. $0.28 = \frac{7}{\boxed{?}}$

Ans: _____

18. What is the greatest whole number that gives 570 when rounded off to the nearest ten?

Ans: _____

19. Glen is facing north-west now.
He makes a 135° anti-clockwise turn. In which direction is he facing now?

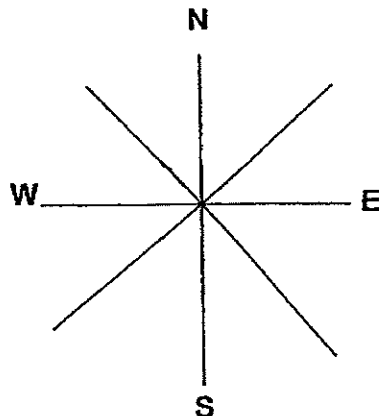

Ans: _____

24. A piece of ribbon was $\frac{3}{5}$ m long. Jeanie bought 6 such ribbons. What was the total length of ribbon which Jeanie bought? Give your answer as a mixed number.

Ans: _____ m

-
25. In the figure below, (not drawn to scale) all the straight lines meet at right angles. Study it carefully and find its perimeter.

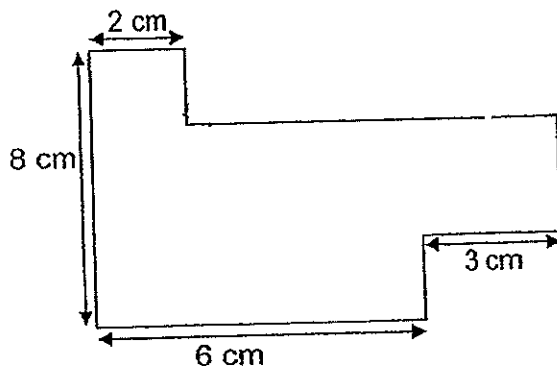

Ans: _____ cm

-
26. Jean had \$685 and Mindy had \$943. How much money must Mindy give to Jean so that she would have \$50 more than Jean?

Ans: \$ _____

27. There are 2065 pupils in a school. $\frac{4}{7}$ of the pupils are girls. There are 5 times as many girls as the teachers in the school. How many teachers are there?

Ans: _____

28. Adrian and Tim had the same amount of money. When Adrian received another \$360 from his father, he had 4 times as much money as Tim. How much money did the two boys have together at first?

Ans: \$ _____

29. Ashley wanted to knit a scarf 225 cm long. On Monday, she started to knit $\frac{1}{5}$ of the length. From Tuesday onwards, she would always knit 30 cm more than the previous day. How many days will she take to complete knitting the scarf?

Ans: _____ days

30. Anthony had a box of oranges. The number of oranges he had was more than 40 but less than 70. If Anthony packed the oranges in bags of 9, he would be short of one. If he packed them in bags of 5, he would have 2 leftover. How many oranges did he have?

Ans: _____ oranges

— End of Paper 1 —



**NAN HUA PRIMARY SCHOOL
CONTINUAL ASSESSMENT 1 – 2014
PRIMARY 5**

MATHEMATICS

Paper 2

Total Time for Paper 2: 1 hour 40 minutes

INSTRUCTION TO CANDIDATES

1. Write your name and index number in the space provided.
2. Do not turn over the page until you are told to do so.
3. Follow all instructions carefully
4. Answer all questions and show your workings clearly.
5. You are allowed to use a calculator.

Marks Obtained

Total		/ 60
--------------	--	-------------

Name : _____ ()

Class : _____

Date : 6 March 2014

Parent's Signature : _____

Questions 1 to 5 carry 2 marks each. Show your working clearly in the space provided for each question and write your answers in the spaces provided. For questions which require units, give your answers in the units stated. [10 marks]

Do not write in this space

1. In the number pattern below, what is the missing number in the box?

1, 4, 9, 16, 36

Answer: _____ [2]

2. 1 kg of tomatoes is sold for \$2 at a market. What is the price of $\frac{4}{5}$ kg of tomatoes? Give your answers in cents.

Answer: _____ ¢ [2]

3. Refer to the grid and compass below and find the missing letter in the box.

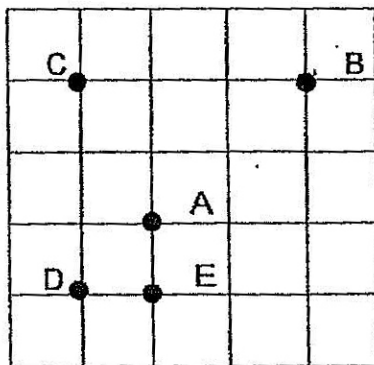

Point is north-east of Point A.

Answer: _____ [2]

4. Rectangle WXYZ below (not drawn to scale) is made up of 4 rectangles.
 The measurements of each side of the rectangle WXYZ is a whole number.
 Find the area of the shaded part.

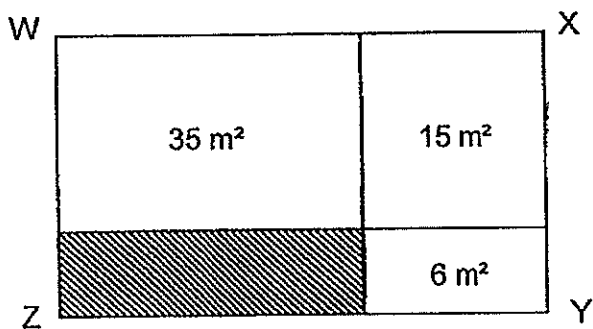

Do not write
in this space

Answer: _____ m^2 [2]

5. Ten similar seeds were planted along a straight line at equal distance apart.
 The distance between the first and the fifth seed was 10 m. What was the
 distance between the first seed and the tenth seed?

Answer: _____ m [2]

For questions 6 to 18, show your working clearly in the space provided for each question and write your answers in the spaces provided. The number of marks available is shown in the brackets [] at the end of each question or part question. [50 marks]

Do not write in this space

6. Files are sold at 5 for \$4 and notebooks are sold at 3 for \$5. Lily bought an equal number of files and notebooks for \$148. How many notebooks did she buy?

Answer: _____ [3]

7. Royce had \$230 more than Matthew. When Matthew gave \$55 to Royce, Royce had 5 times as much money as Matthew. How much money had Matthew at first?

Answer: _____ [3]

8. Lydia was given 380 tickets and Amelie was given 500 tickets to sell. After selling an equal number of tickets, Amelie had 4 times as many tickets left as Lydia. How many tickets did each of them sell?

Do not write
in this space

Answer: _____ [3]

9. Study the pattern below form by identical cubes. Which figure will be formed by 23 such cubes?

Figure 1



Figure 2

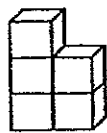

Figure 3



Answer: _____ [3]

10. On a farm, there are some pigs and ducks. They have a total of 130 eyes and 160 legs. How many ducks are there?

Do not write
in this space

Answer: _____ [3]

11. Mary had a box of blue, yellow, red and green ribbons. $\frac{1}{3}$ of the ribbons were blue and $\frac{1}{2}$ of the ribbons were yellow. After removing all the blue and yellow ribbons, Mary found that $\frac{1}{2}$ of the ribbons left in the box were red.
- (a) What fraction of the ribbons that Mary had were red?
- (b) If Mary had 27 more blue ribbons than red ribbons, how many ribbons did Mary have in all?

Answer: (a) _____ [2]

(b) _____ [2]

12. Jacky and Michael saved \$240 altogether. Keith and Jacky saved \$90 altogether. Michael's savings was 6 times as much as Keith's savings. What was the total savings of the three boys?

Do not write
in this space

Answer: _____ [4]

13. Kelvin had some 10-cent and 50-cent coins in his savings bank. He had 8 more 10-cent coins than 50-cent coins. The total value of the coins was \$15.80. What was the total number of coins that Kelvin had?

Answer: _____ [4]

14. 3 similar watches and 5 similar handbags cost \$915. 4 such watches and 2 such handbags cost \$632.
What was the total cost of 2 such watches and 2 such handbags?

Do not write
in this space

Answer: _____ [4]

15. The figure below shows a rectangular piece of paper (not drawn to scale) that is folded at a corner. The length of the rectangular piece of paper is twice its breadth. The folded part (shaded) has an area of 216 cm^2 . What fraction of the rectangular paper is the folded part?
Give your answer in the simplest form.

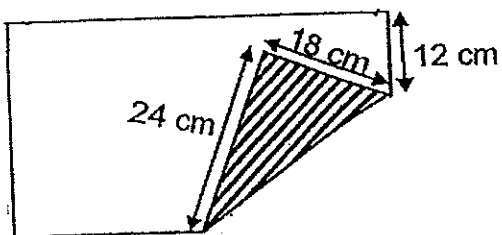

Answer: _____ [4]

16. Alycia, Brenda and Charmaine had 450 beads altogether. Alycia gave some of her beads to Brenda and Brenda's number of beads was doubled. Then Brenda gave some of her beads to Charmaine and Charmaine's number of beads was tripled. As a result, the three girls had an equal number of beads each. How many more beads did Alycia have than Charmaine at first?

Do not write
in this space

Answer: _____ [5]

17. Ashton bought some strawberry, mango and durian sweets. The number of strawberry sweets were four times as many as the number of mango sweets. The total number of strawberry and mango sweets was thrice the number of durian sweets.

Do not write
in this space

- (a) What fraction of all the sweets were strawberry sweets? Give your answer in the simplest form.
- (b) If there were 50 more durian sweets than mango sweets, how many sweets did Ashton buy altogether?

Answer: (a) _____ [3]

(b) _____ [2]

18. After Dora had used 53 of her stickers, Dora had twice as many stickers as Victoria. Victoria then bought 225 stickers and in the end, Victoria had thrice as many stickers as Dora.

(a) How many stickers did Dora have at first?

(b) How many stickers must Victoria give to Dora so that Dora will have thrice as many stickers as Victoria?

Do not write
in this space

Answer: (a) _____ [3]

(b) _____ [2]

- End of Paper -

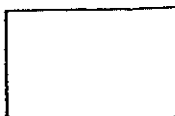

**Nan Hua primary school
Continual Assessment 1 (2014)**

Primary 5

- 1) 3
 - 2) 3
 - 3) 2
 - 4) 3
 - 5) 4
 - 6) 2
 - 7) 4
 - 8) 3
 - 9) 2
 - 10) 3
 - 11) 2
 - 12) 1
 - 13) 4
 - 14) 1
 - 15) 3
 - 16) Three hundred and fifty thousand and ninety-four
 - 17) 25
 - 18) 574
 - 19) south
 - 20) 861 (pls note, for any number that is divisible by 3, sum up the digits, if the sum of the digits is divisible by 3, then number is divisible by 3)
 - 21) 59
 - 22) 11 40
 - 23) \$77
 - 24) 3/3/5 m.
 - 25) 34 cm
 - 26) \$ 104
 - 27) 236 teachers
 - 28) \$240
 - 29) 3 days
 - 30) 62 oranges
- $2+1=3$
 $9-5=4$
 $3*4=12$
 $12*5=60$
 $60+2=62$

Paper 2

1) $4-1=3$

$9-4=5$

$16-9=7$

$16+9=25$

2) $200/5=40$

$40*4=160c$

3) B

4) $15+6=21$

$35-21=14 \text{ sq m}$

5) $10/4=2.5$

$2.5*9=22.5 \text{ m}$

6) $4*3=12$ (15 files)

$5*5=25$ (15 notebooks)

$12+25=37$ (15 files & 15 notebooks)

$148/37=4$ sets

$15*4=60$ notebooks

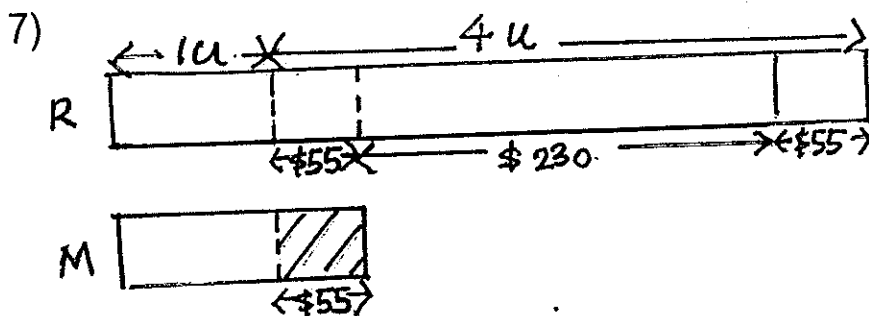

$55+230+55=340$

$340/4=85$

$85+55=\$140$

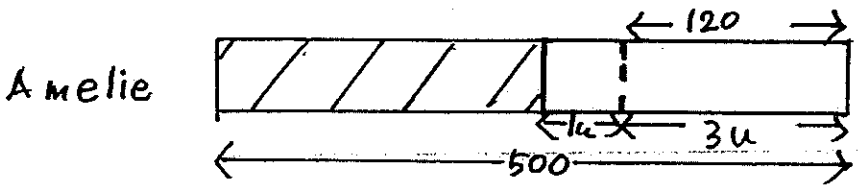
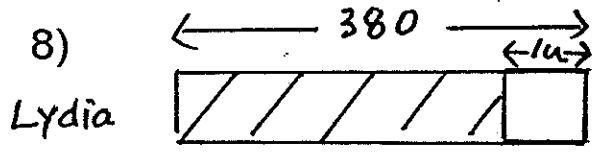

$$500 - 380 = 120$$

$$120 / 3 = 40$$

$$380 - 40 = 340 \text{ tickets}$$

9)

$$3 = 1 \cdot 2 + 1$$

$$5 = 2 \cdot 2 + 1$$

$$7 = 3 \cdot 2 + 1$$

$$23 = ?$$

$$23 - 1 = 22$$

$$22 / 2 = 11$$

10) Assume all are pigs.

$$130 / 2 = 65$$

$$65 \cdot 4 = 260$$

$$260 - 160 = 100$$

$$100 / 2 = 50 \text{ (ducks)}$$

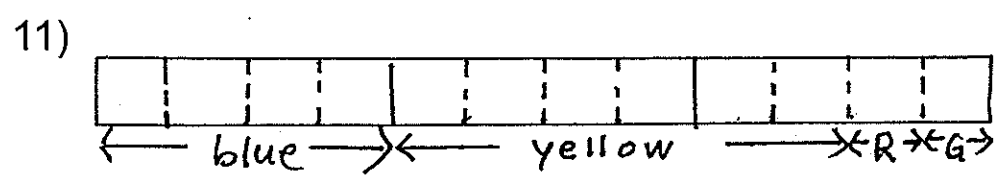

a) $1/12$

b) $27/3 = 9$

$$9 \cdot 12 = 108 \text{ ribbons}$$

12) $J+M \rightarrow 240$

$J+K \rightarrow 90$

Difference = $240-90 = 150$

$150/5 = 30$ (Keith)

$90-30 = 60$ (Jacky)

Total savings of the 3 boys = $240+90-60 = \$270$

13)

10 ¢

	8
--	---

50 ¢

--

$8 \times 0.10 = 0.80$

$15.80 - 0.80 = 15$

$0.10 + 0.50 = 0.60$

$15 / 0.60 = 25$

$25 \times 2 = 50$

$50 + 8 = 58$ coins

14) 3 watches + 5 handbags = \$915

4 watches + 2 handbags = \$632

Hence 7 watches + 7 handbags = $\$915 + \$632 = \$1547$

So, 1 watch + 1 handbag = $1547/7 = \$221$

Therefore 2 watches + 2 handbags = $\$221 \times 2 = \442

15) $18+12 = 30$

$60 \times 30 = 1800$

$216/1800 = 3/25$

16) $450/3 = 150$

$150/3 = 50$ (Charmaine)

$50 \times 2 = 100$

$100 + 150 = 250$

$250/2 = 125$

$125 + 150 = 275$ (Alycia)

$275 - 50 = 225$

17)
Strawberry

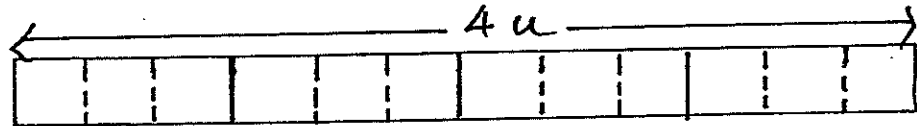

Mango

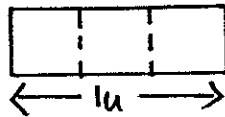

Durian



a) $12/20 = 3/5$

b) $50/2 = 25$

$20 \cdot 25 = 500$

18)

Dora



Victoria

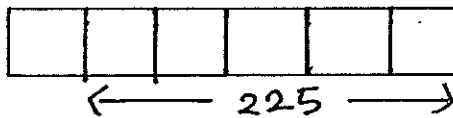

a) $225/5 = 45$

$45 \cdot 2 = 90$

$90 + 53 = 143$ stickers

b) $225 + 45 = 270$

$270 + 90 = 360$

$360/4 = 90$

$270 - 90 = 180$ stickers

