

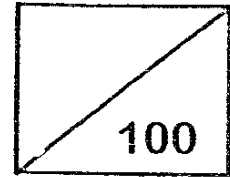

Rosyth School  
First Continual Assessment 2007  
Mathematics  
Primary 5



Name: \_\_\_\_\_

Class: Pr 5-\_\_\_\_\_ Register No. \_\_\_\_\_ Duration: 2 h 15 min

Date: 27 February 2007 Parent's Signature: \_\_\_\_\_

Instructions to Pupils:

1. Do not open this booklet until you are told to do so.
2. Follow all instructions carefully.
3. This paper consists of 3 parts, Sections A, B and C.
4. For questions 1 to 15 in Section A, shade the correct ovals on the Optical Answer Sheet (OAS).

	<b>Maximum</b>	<b>Marks Obtained</b>
<b>Section A</b>	30	
<b>Section B</b>	30	
<b>Section C</b>	40	
<b>Total</b>	100	

\* This paper consists of 19 pages altogether.

This paper is not to be reproduced in part or whole without the permission of the Principal.

**Section A**

Question 1 to 15 carries 2 marks each. For each question, four options are given. One of them is the correct answer. Make your choice (1, 2, 3 and 4). Shade the correct answer on the OAS (Optical Answer Sheet).  
(30 marks)

---

- 1) Round off 408 912 to the nearest thousand.
- (1) 400 000
  - (2) 408 000
  - (3) 408 900
  - (4) 409 000
- 2) In the number 806 271, what does the digit 6 stand for?
- (1) 600
  - (2) 6000
  - (3) 60 000
  - (4) 600 000
- 3) Find the value of  $180 \times 50$ .
- (1) 90
  - (2) 900
  - (3) 9000
  - (4) 90 000

4) Find the value of  $18 + 8 \div 2 \times 4$ .

- (1) 19
- (2) 34
- (3) 52
- (4) 88

5) Find the value in the box.

53 hundreds + 9 tens =  tens

- (1) 62
- (2) 539
- (3) 620
- (4) 5 390

6) Find the area of the triangle shown below.

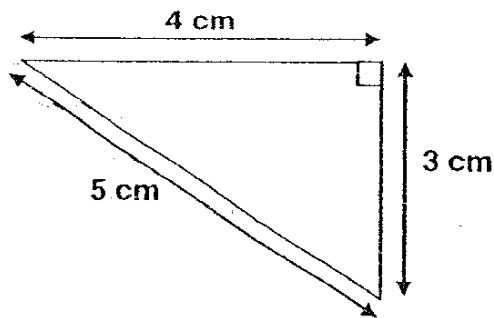

- (1)  $6 \text{ cm}^2$
- (2)  $12 \text{ cm}^2$
- (3)  $15 \text{ cm}^2$
- (4)  $20 \text{ cm}^2$

7) Identify the line(s) of symmetry for the rectangle below.

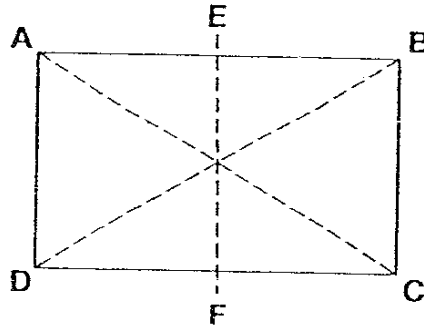

- (1) EF
- (2) BD
- (3) AC
- (4) All of the above are lines of symmetry for the rectangle..

8) Find the value of  $6\ 340\ 000 \div 100$ .

- (1) 634
- (2) 6340
- (3) 63 400
- (4) 634 000

9) What is the value of  $(7 + 7) \times 4 + 5$ ?

- (1) 40
- (2) 61
- (3) 126
- (4) 201

10) 24 children shared a box of toy cars. After each child had taken 15 toy cars, there were 8 toy cars left. How many toy cars were in the box at first?

(1) 207

(2) 352

(3) 360

(4) 368

11) An office assistant bought a colour printer and 12 ink cartridges for \$624. The cost of the colour printer is the same as the total cost of the 12 ink cartridges. What is the cost of each ink cartridge?

(1) \$24

(2) \$26

(3) \$48

(4) \$52

12)  $28 \times 3 + 36 \square 3 = 96$

What is the missing sign in the box?

(1)  $\div$

(2)  $\times$

(3)  $-$

(4)  $+$

13) When a number is divided by 5, the quotient is 6. What is the quotient when the same number is divided by 30?





- (1) 1
- (2) 10
- (3) 100
- (4) 1000

14) Rachel and Gordon have \$100. Rachel and Ryan have \$180. Ryan has 3 times as much money as Gordon. How much money does Rachel have?

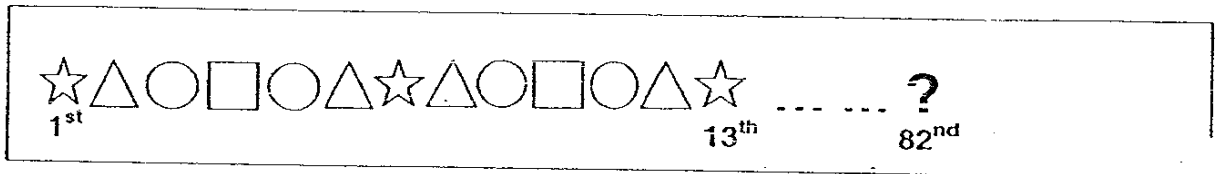
- (1) \$40
- (2) \$60
- (3) \$80
- (4) \$120

15) Joshua used four different shapes to make a pattern. The first 13 stickers are shown below. What was the shape of the 82<sup>nd</sup> sticker?



- (1) 
- (2) 
- (3) 
- (4) 

**Section B**

Questions 16 to 25 carry 1 mark each. Write your answers in the spaces provided. For questions which require units, give your answers in the units stated. (10 marks)

---

16) What is eight million, five hundred thousand and forty in numerals?

Ans: \_\_\_\_\_

---

17) 500 ~~000~~ = \_\_\_\_\_ thousands

Ans: \_\_\_\_\_

---

18) Round off 369 999 to the nearest hundred.

Ans: \_\_\_\_\_

---

19) What number is 100 000 less than 3 059 800?

Ans: \_\_\_\_\_

---

20) What is the missing number in the box?

$$400 \times 367 - \boxed{\phantom{000}} = 367 \times 399$$

Ans: \_\_\_\_\_

21) What is the product of 206 and 50?

Ans: \_\_\_\_\_

22) Estimate the sum of 5 892 and 8 400 by first rounding off the numbers to the nearest thousand.

Ans: \_\_\_\_\_

23) Find the area of triangle XYZ.

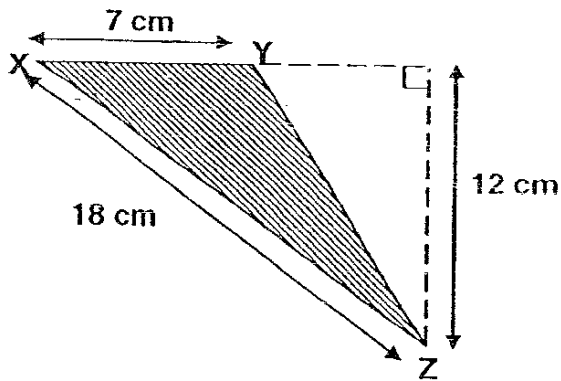

Ans: \_\_\_\_\_  $\text{cm}^2$



24) Complete the figure below so that the dotted line AB is the line of symmetry.

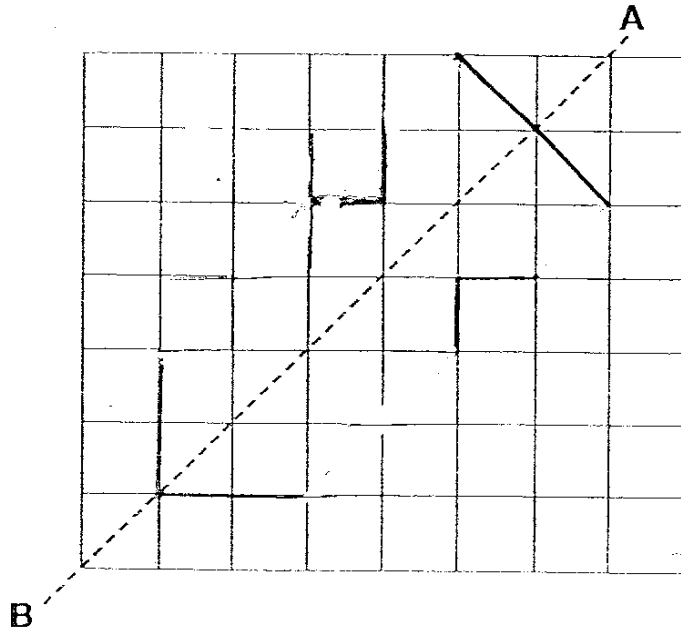

25) Shade two more squares to complete the figure which has the dotted line CD as a line of symmetry.

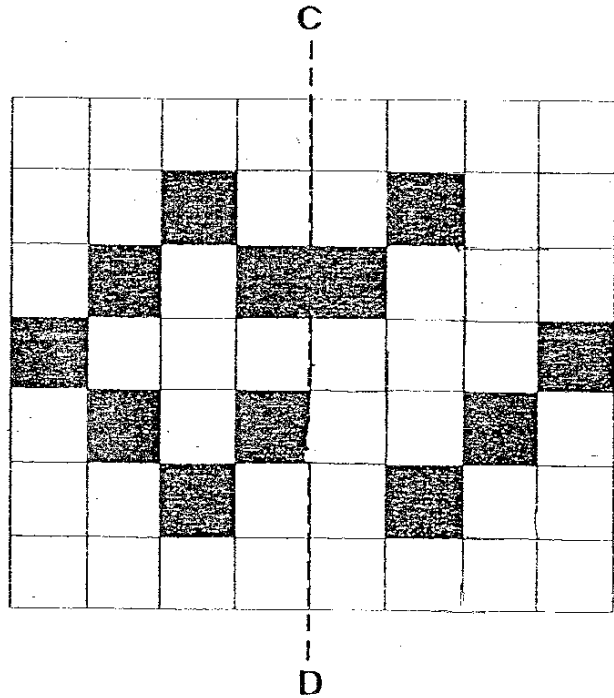

Questions 26 to 35 carry 2 marks each. Show your working clearly in the space below each question and write your answers in the spaces provided. For questions which require units, give your answers in the units stated. (20 marks)

26) ABCD is a rectangle 12 cm by 6 cm. BF is 4 cm. Find the area of triangle AFC.

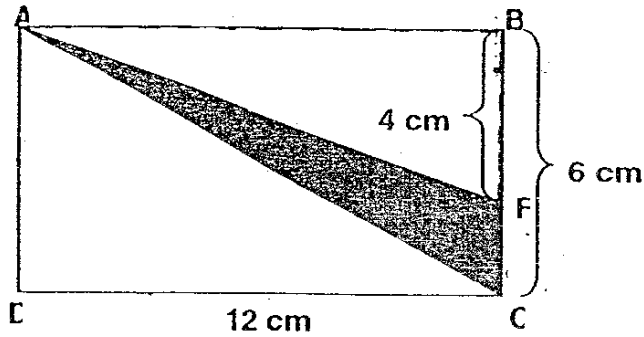

Ans: \_\_\_\_\_ cm<sup>2</sup>

27) Count forward in steps of 200 000 from 6 500 000.

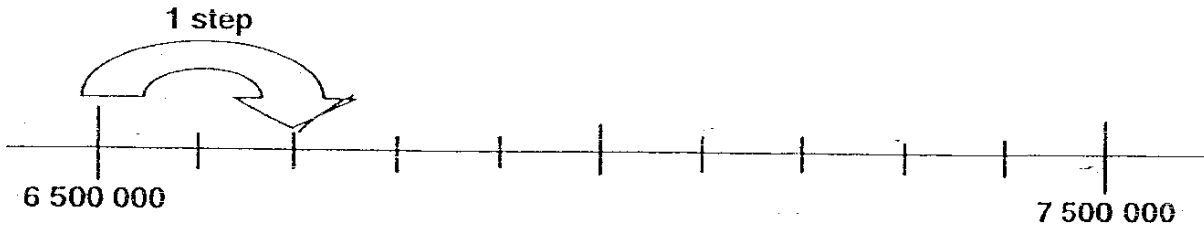

What is the number after the 4<sup>th</sup> step?

Ans: \_\_\_\_\_

28) Count backward in steps of 3 000 from 8 500 000.

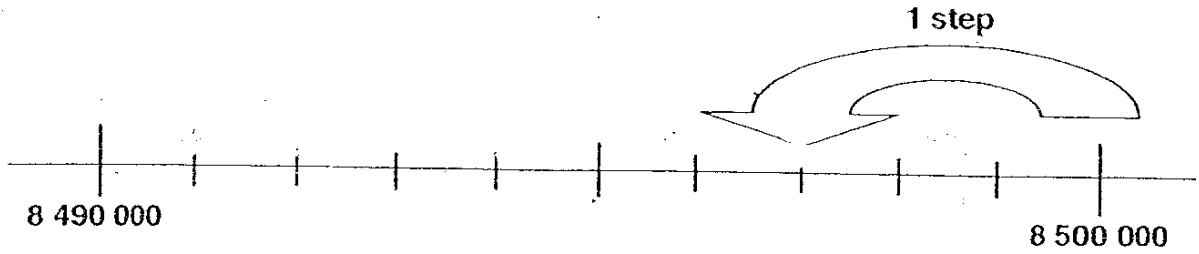

What is the number after the 3<sup>rd</sup> step?

Ans: \_\_\_\_\_

29) The school is hiring buses to send 537 Primary Five pupils and teachers for the NE Show in July this year. Each bus can take only 42 people. What is the least number of buses that the school needs to hire?

Ans: \_\_\_\_\_

30) Find the area of the shaded triangle.

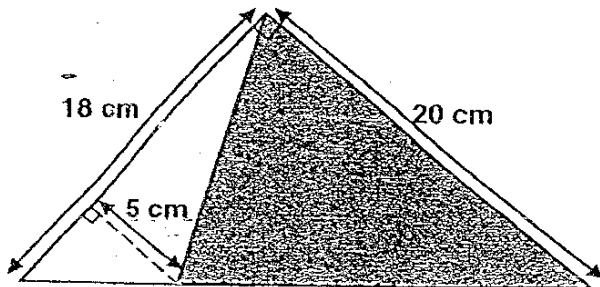

Ans: \_\_\_\_\_ cm<sup>2</sup>

31) Complete the number pattern below:

1, 1, 2, 3, 5, 8, 13, \_\_\_\_\_, 34

Ans: \_\_\_\_\_

---

32) At a Bus-Stop A, 15 passengers alighted from a bus.

At a Bus Stop B, 8 passengers alighted from a bus.

There are 28 passengers in the bus now. How many passengers were there in the bus at first?

Ans: \_\_\_\_\_

---

33) Jovan and Ivan swam at the swimming pool on the 1<sup>st</sup> of March. Jovan swims at the pool once every 3 days while Ivan swims once every 5 days. Find the **date** when they would next meet each other again at the swimming pool.

Ans:

Day
-----

Month
-------

- 34) Xiuli and Hamid shared a sum of money. Hamid had 2 times more money than Xiuli. If he had \$34 more than her, find the total sum of money both of them had.

Ans: \$ \_\_\_\_\_

---

- 35) A fruit seller has 50 more apples than oranges. After selling half of the apples, there were 30 more oranges than apples. How many apples and oranges does the fruit seller have at first?

Ans: \_\_\_\_\_

---

**Section C**

For questions 36 to 46, show your working clearly in the space provided for each question and write your answers in the spaces provided.

The number of marks available is shown in brackets [ ] at the end of each question or part question. (40 marks)

---

- 36) A group of 10 boys and 6 girls collected \$420 for the School Pocket Money Fund. Each girl collected thrice as much as each boy. How much money did each boy collect?

Ans: \_\_\_\_\_ [3]

---

- 37) Mr Chandran is 43 years old when his son is 18. How many years later will Mr Chandran be twice as old as his son?

Ans: \_\_\_\_\_ [3]

- 38) Alvin was reading his favourite storybook when the telephone rang. He stopped reading to answer the telephone. The two facing pages where he placed his bookmark had page numbers that added up to 555. Find the smaller page number.

Ans: \_\_\_\_\_ [3]

---

- 39) Jessica had 492 beads and Kayla had 128 beads. Jessica gave Kayla some beads so that they have the same number of beads. How many beads did Jessica give Kayla?

Ans: \_\_\_\_\_ [3]

- 40) Rani had 12 postage stamps with a total value of \$3.20. Some of her stamps were 20-cent stamps and the rest were 30-cent stamps. How many 20-cent and 30-cent stamps did Rani have?

Ans: \_\_\_\_\_ 20-cent stamps }  
\_\_\_\_\_ 30-cent stamps } [3]

---

- 41) Three boys have a total of 72 toy cars. Tom had 3 times as many toy cars as Jerry. Paul has 7 more toy cars than Jerry. What is the difference in the number of toy cars between Tom and Paul?

Ans: \_\_\_\_\_ [4]



42) Mrs Ng had \$12 which was just enough to buy 2 kg of flour and 3 kg of rice. Instead, she bought 3 kg of flour and 2 kg of rice and had \$1.50 left.

(a) What is the cost of 1 kg of flour?

(b) What is the cost of 1 kg of rice?

Ans: (a) \_\_\_\_\_ [3]

(b) \_\_\_\_\_ [1]

43) The figure below is made up of equilateral triangles of different sizes.

Find the area of the shaded equilateral triangle.

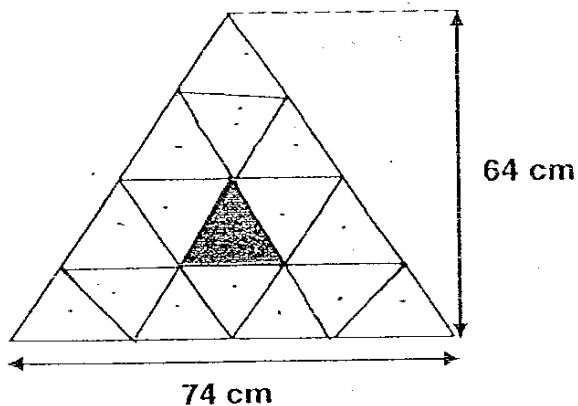

Ans: \_\_\_\_\_ [4]

44) Look at the following figures that are formed by squares of the same size.

Figure 1



Figure 2

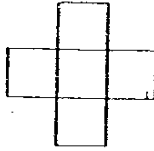
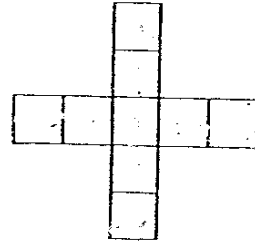

Figure 3



- (a) How many squares would make up Figure 4?
- (b) How many squares would make up Figure 51?

Ans: (a) \_\_\_\_\_ [1]

(b) \_\_\_\_\_ [3]

- 45) A shopkeeper had 14 boxes of mangoes. There were 58 mangoes in each box. He sold 182 mangoes on Monday and 210 mangoes on Tuesday. He then packed the rest into packets of 20 mangoes each. How many packets of mangoes did he pack?

Ans: \_\_\_\_\_ [5]

40. Chad, Delicia, Grace and Edward gave stickers to one another. Chad gave Delicia 5 stickers and Edward 10 stickers. Edward gave 9 stickers to Chad. Delicia gave 7 stickers to Grace. Grace gave Chad 3 stickers and 6 stickers to Delicia.

- (a) How many stickers did Delicia receive?
- (b) Who received the most number of stickers?

Ans: (a) \_\_\_\_\_ [2]

(b) \_\_\_\_\_ [3]

**END OF PAPER**

*Have you checked your work thoroughly?*

Rosyth Primary School  
Primary 5 Maths CA1 Exam (2007)

*Answer Keys*

Q1	Q2	Q3	Q4	Q5
4	2	3	2	2
Q6	Q7	Q8	Q9	Q10
1	1	2	2	4
Q11	Q12	Q13	Q14	Q15
2	1	1	2	3

16. 8500040

17. 500

18. 37000

19. 2959800

20. 367

21. 10300

22. 1400

23. 42cm<sup>2</sup>

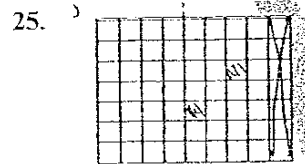
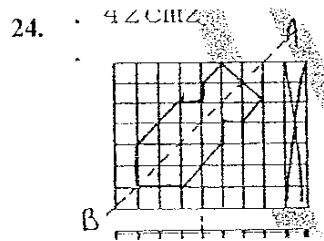

26. 12cm<sup>2</sup>

27. 7300000

28. 8491000

29. 13

30. 135cm<sup>2</sup>

31. 21

32. 51 passengers

33. 16, March

34. \$68

35. 270 at first

- |      |             |     |                    |
|------|-------------|-----|--------------------|
| 36.  | \$15        | 37. | 7 years later      |
| 38.  | Page 277    | 39. | 182 beads          |
| 40.  | 4, 8        | 41. | 19 toy cars        |
| 42a. | \$1.50      | 43  | 148cm <sup>2</sup> |
| 42b. | \$3         |     |                    |
| 44a. | 13 squares  | 45. | 21 packets         |
| 44b. | 201 squares |     |                    |
| 46a. | 11          |     |                    |
| 46b. | Delicia     |     |                    |