



2021 PRIMARY 5 END-OF-YEAR EXAMINATION

Name: _____ () Date: 28 October 2021

Class: Primary 5 () Time: 8.00 a.m. - 9.00 a.m.

Parent's Signature: _____

Paper 1 comprises 2 booklets, A and B.

MATHEMATICS

PAPER 1

(BOOKLET A)

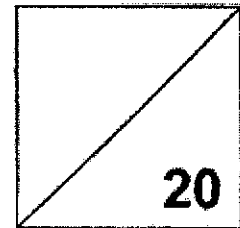

INSTRUCTIONS TO CANDIDATES

1. Write your name, class and register number.
2. Do not turn over this page until you are told to do so.
3. Follow all instructions carefully.
4. Answer all questions.
5. Shade your answers in the Optical Answer Sheet (OAS) provided.
6. You are not allowed to use a calculator.

Questions 1 to 10 carry 1 mark each. Questions 11 to 15 carry 2 marks each.
For each question, four options are given. One of them is the correct answer.
Make your choice (1, 2, 3 or 4).
Shade the oval (1, 2, 3 or 4) on the Optical Answer Sheet. (20 marks)

1. Express seven million, six hundred and fifteen thousand and eight in numerals.
 - (1) 7 615 800
 - (2) 7 615 008
 - (3) 7 061 508
 - (4) 7 015 608

2. The mass of 10 Singapore \$1 coins is about _____.
 - (1) 0.76 g
 - (2) 7.6 g
 - (3) 76 g
 - (4) 760 g

3. Express 0.018 as a percentage.
 - (1) 0.018%
 - (2) 0.18%
 - (3) 1.8%
 - (4) 18%

4. Find the difference between 0.08 and 7.324.
 - (1) 7.244
 - (2) 7.316
 - (3) 7.332
 - (4) 7.404

5. Find the product of $\frac{8}{3}$ and $\frac{5}{12}$.

(1) $\frac{5}{32}$

(2) $\frac{9}{10}$

(3) $1\frac{1}{9}$

(4) $6\frac{2}{5}$

6. How many quarter turns does the minute hand of a clock make from 10.30 a.m. to 1 p.m.?

(1) 3

(2) 5

(3) 6

(4) 10

7. A rectangular tank measures 20 cm by 20 cm by 30 cm.
What is the capacity of the tank?

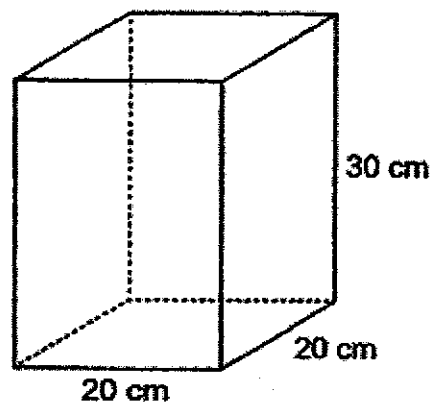

(1) 6000 cm³

(2) 9000 cm³

(3) 12 000 cm³

(4) 18 000 cm³

8. Samad runs thrice a week. Each time, he runs $2\frac{1}{4}$ km from his home to the park. Then he returns on the same route from the park to his home. What is the total distance that Samad runs in a week?

- (1) $4\frac{1}{2}$ km
 (2) $6\frac{3}{4}$ km
 (3) $13\frac{1}{2}$ km
 (4) $15\frac{3}{4}$ km

9. The figure below is divided into 36 equal squares. How many more squares must be shaded so that 50% of the figure is shaded?

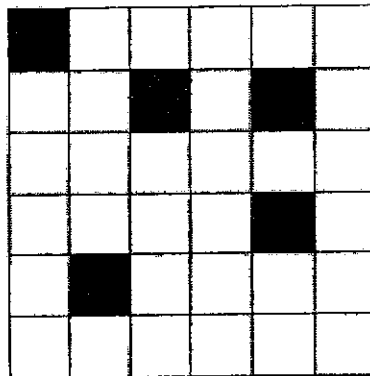

- (1) 13
 (2) 18
 (3) 23
 (4) 31

10. The table shows the number of books read by some students.
How many students read at least 3 books?

<i>Number of books</i>	<i>Number of students</i>
0	18
1	37
2	52
3	66
4	45
more than 5	27

- (1) 66
(2) 72
(3) 107
(4) 138
11. There are 25 goats and ducks on a farm and there are a total of 68 legs.
How many ducks are there?
- (1) 9
(2) 12
(3) 15
(4) 16
12. The total mass of 20 identical cookie jars is 4.7 kg.
Find the mass of 3 cookie jars.
- (1) 0.235 kg
(2) 0.705 kg
(3) 2.35 kg
(4) 7.05 kg

13. Raj packed sweets into three containers, A, B and C, in the ratio 3 : 4 : 2. He packed 30 sweets into container A. How many sweets did he have altogether?

- (1) 90
- (2) 70
- (3) 60
- (4) 50

14. The diagram below shows the different places in a neighbourhood.

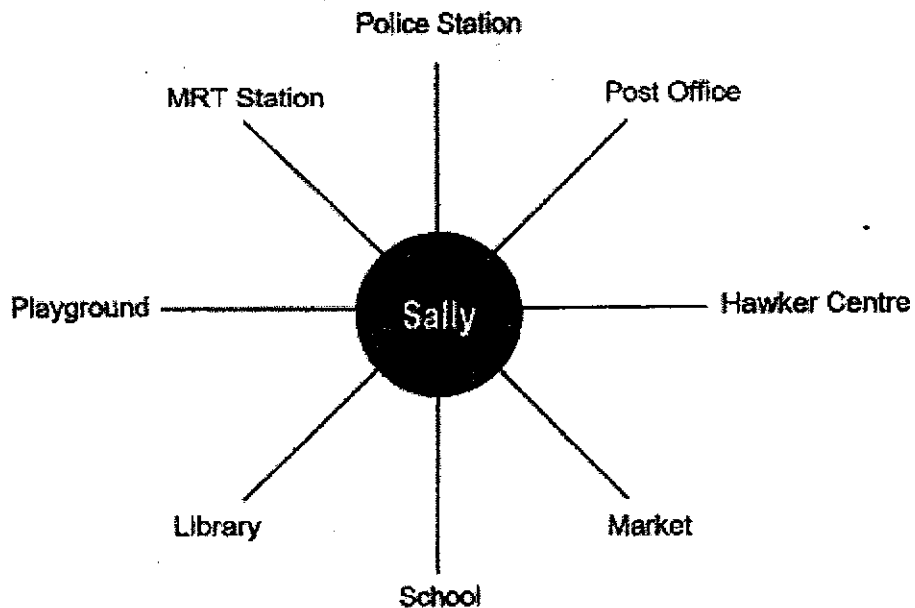

Sally is facing the library after turning 270° anti-clockwise. Where was she facing at first?

- (1) Market
- (2) Playground
- (3) MRT Station
- (4) Hawker Centre

15. The figure is made up of a rectangle and a triangle.
Find the shaded area.

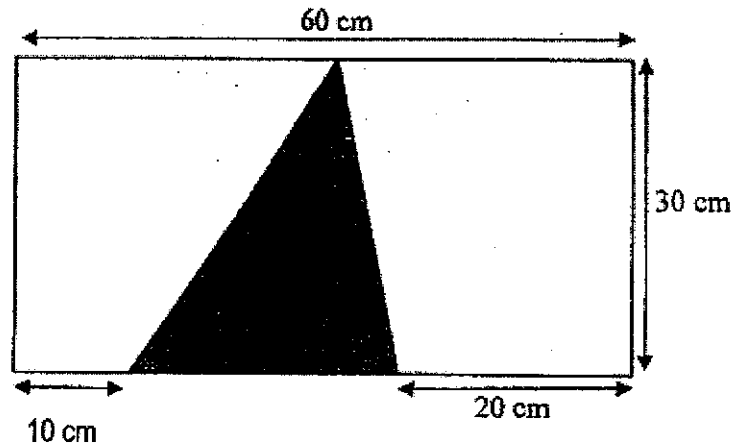

- (1) 1800 cm^2
- (2) 900 cm^2
- (3) 450 cm^2
- (4) 225 cm^2

End of Booklet A

Go on to Booklet B



2021 PRIMARY 5 END-OF-YEAR EXAMINATION

Name: _____ () Date: 28 October 2021

Class: Primary 5 () Time: 8.00 a.m. - 9.00 a.m.

Parent's Signature: _____

Paper 1 comprises 2 booklets, A and B.

MATHEMATICS

PAPER 1

(BOOKLET B)

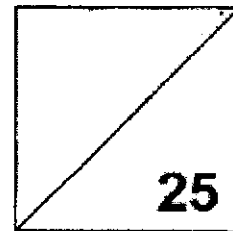

INSTRUCTIONS TO CANDIDATES

1. Write your name, class and register number.
2. Do not turn over this page until you are told to do so.
3. Follow all instructions carefully.
4. Answer all questions.
5. Write your answers in this booklet.
6. You are **not** allowed to use a calculator.

Questions 16 to 20 carry 1 mark each. Write your answers in the spaces provided.
For questions which require units, give your answers in the units stated. (5 marks)

16. Which letter has both parallel and perpendicular lines?

H A S

Ans: _____

17. Express 7 tens and 23 tenths in numerals.

Ans: _____

18. Find the sum of $\frac{1}{6}$ and $1\frac{3}{4}$. Express your answer in its simplest form.

Ans: _____

19. Three students took part in a race. Ali took 48 s to complete the race. Bala took 3 s more than Ali while Cari was faster than Bala by 1 s. How long did Cari take to complete the race?

Ans: _____ s

20. The bar graph shows the number of stamps Raju collected over 6 months.

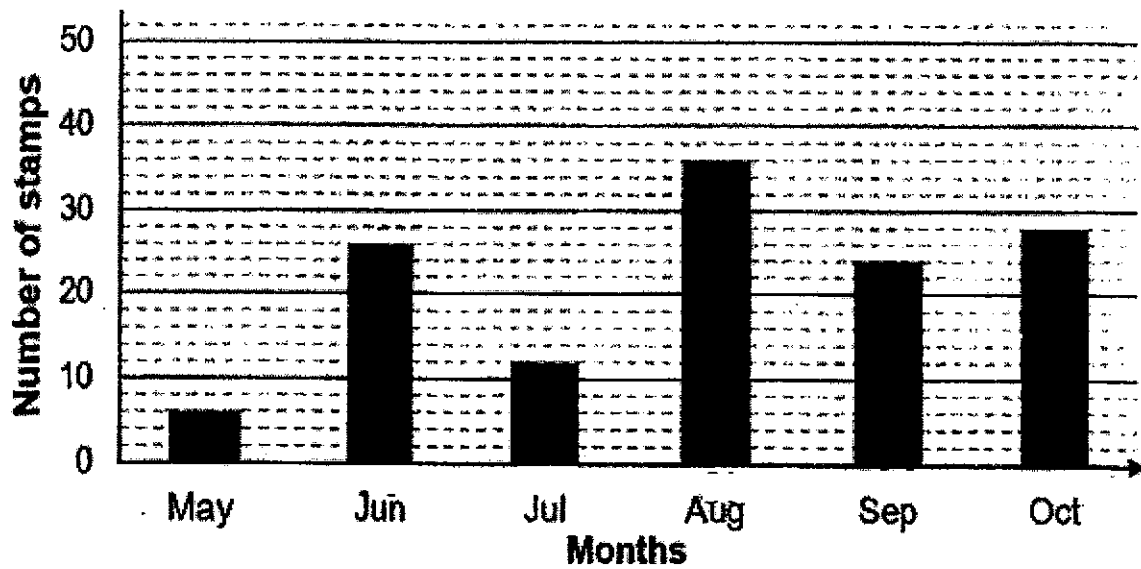

In which month did he collect twice as many stamps as he did in July?

Ans: _____

Questions 21 to 30 carry 2 marks each. Show your working clearly in the space provided for each question and write your answers in the spaces provided. For questions which require units, give your answers in the units stated. (20 marks)

21. Use all the digits below to form the greatest odd number.



Ans: _____

22. $\frac{5}{12}$ of $\frac{a}{4}$ of number is 15. What is $\frac{5}{6}$ of the number?

Ans: _____

23. The ratio of A : B is 1 : 2 and the ratio of B : C is 3 : 4.
What is the ratio of A : C?

Ans: _____

24. Mary had \$50. She spent \$35 and saved the rest.
What percentage of her money did she save?

Ans: _____ %

25. Huiyi is 1.6 m tall. She is 3 cm taller than her sister.
What is her sister's height?

Ans: _____ m

26. In the figure below, shade 2 squares such that the figure is symmetrical along the line XY.

Ans:

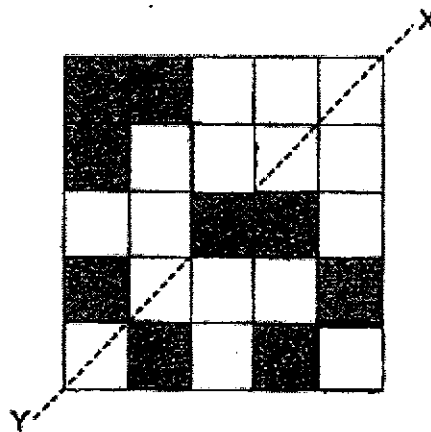

27. Water flows from a water tank at the rate of 450 m³ every minute.
At this rate, how much water flows from the water tank in 20 seconds?

Ans: _____ m³

28. The figure is made up of a rectangle, a square and an equilateral triangle.
Find the perimeter of the figure.

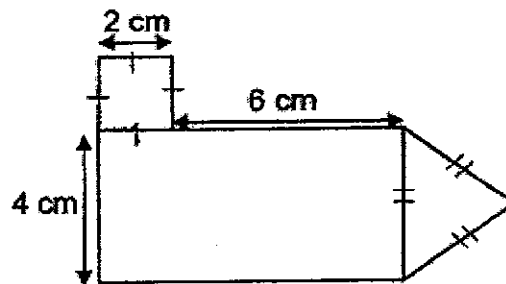

Ans: _____ cm

29. Raju started saving some money on Monday. Each day, he saved \$0.50 more than the day before. He saved a total of \$9 from Monday to Thursday. How much did Raju save on Monday?

Ans: \$ _____

30. The line graph shows the amount of money ^{Aminah has} saved at the end of each week from Week 1 to Week 4.

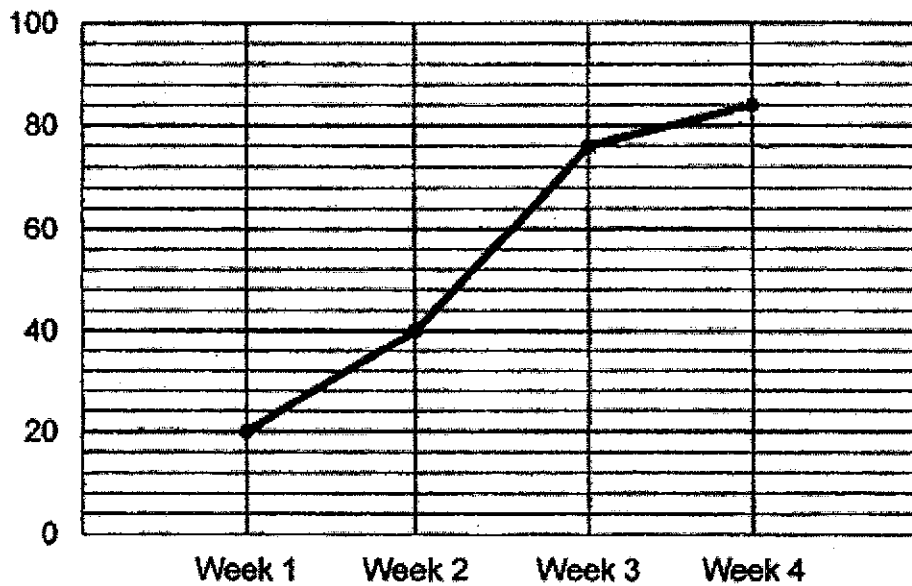

Aminah wants to buy a present that cost \$82.

By which week will she have enough money to buy the present?

Ans: Week _____

End of Booklet B
End of Paper 1

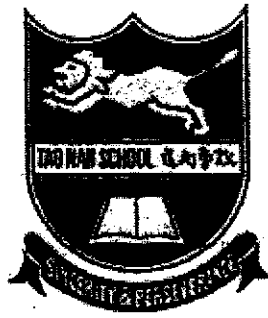

2021 PRIMARY 5 END-OF-YEAR EXAMINATION

Name: _____ () Date: 28 October 2021

Class: Primary 5 () Time: 11.00 a.m. - 12.30 p.m.

Parent's Signature: _____

MATHEMATICS PAPER 2

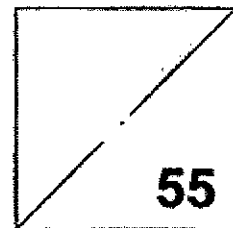

INSTRUCTIONS TO CANDIDATES

1. Write your name, class and register number.
2. Do not turn over this page until you are told to do so.
3. Follow all instructions carefully.
4. Answer all questions.
5. Show your working clearly as marks are awarded for correct working.
6. You are allowed to use a calculator.

Questions 1 to 5 carry 2 marks each. Show your working clearly in the space provided for each question and write your answers in the spaces provided. For questions which require units, give your answers in the units stated. (10 marks)

1. At a wet market, squids are sold at \$1.68 for every 100g.

How much does $1\frac{1}{10}$ kg of squids cost?

Ans: \$ _____

2. The following figure, not drawn to scale, is made up of straight lines.
Calculate $\angle y$.

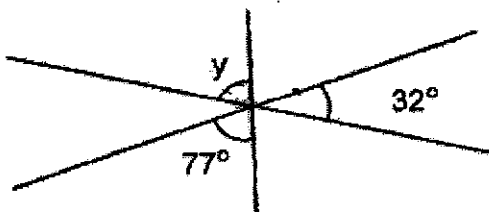

Ans: $\angle y =$ _____ $^{\circ}$

3. Bala's daily screen time on his laptop is 35 minutes on weekdays and 1 hour daily on Saturdays and Sundays. Bala was given $7\frac{1}{2}$ hours of total screen time based on this arrangement. He started on Friday. On which day would he complete the total duration?

Ans: _____

4. Find the sum of all the odd numbers that are less than 40.

Ans: _____

5. Rectangle A and Rectangle B overlap each other. Given that $\frac{1}{6}$ of Rectangle A is shaded while $\frac{1}{4}$ of Rectangle B is shaded, what fraction of the figure is not shaded?

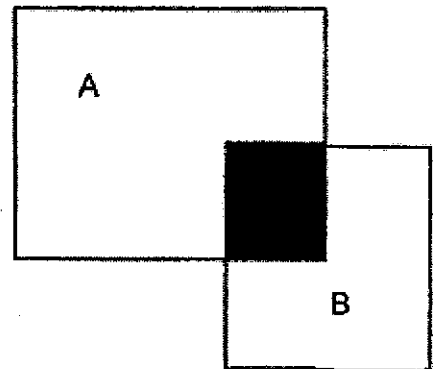

Ans: _____

For questions 6 to 17, show your working clearly in the space provided for each question and write your answers in the spaces provided.
The number of marks available is shown in brackets [] at the end of each question or part-question. (45 marks)

6. 2 mangoes and 1 durian cost \$9.10. A mango and 2 durians cost \$12.80.
Find the total cost of a mango and a durian.

Ans: _____ [3]

7. A typist can type 90 words per minute. For every 360 words, 7 words are typed wrongly. At this rate, how many words are typed correctly in 16 minutes?

Ans: _____ [3]

8. A rectangular tank is 75% filled with water. How much more water is needed to fill it completely? Give your answer in litres.

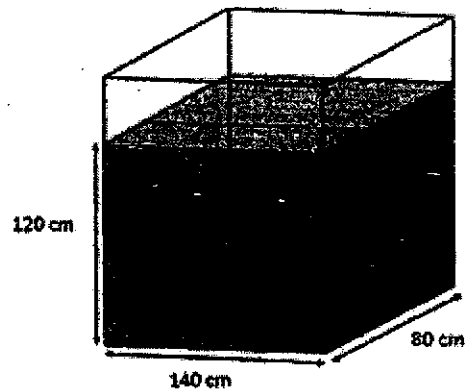

Ans: _____ [3]

9. This year, Kai Xuan's age is a multiple of 7. Next year, his age will be a multiple of 5. He is between 20 years old and 60 years-old. How old will he be in 6 years' time?

Ans: _____ [3]

10. During a sale, Mr Shafi sold 2 identical laptops for \$3600. This was after a 25% discount. What was the original price of one laptop?



Ans: _____ [3]

11. The figure shows two squares and a shaded triangle.
Find the shaded area.

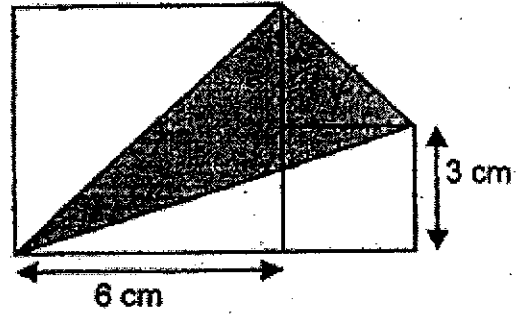

Ans: _____ [4]

12. Anne, Ming and Shanta had sweets in the ratio of 10 : 5 : 3. After Anne gave 68 sweets to Ming and Shanta, the three of them had the same number of sweets.

- a) Find the ratio of the number of sweets that Anne had to the number of sweets Ming had to the number of sweets that Shanta had in the end.
- b) Find the total number of sweets the children had.

Ans: (a) _____ [1]

(b) _____ [3]

13. The first 15 numbers of a number pattern are given below.

4, 0, 1, 2, 4, 0, 1, 2, 4, 0, 1, 2, 4, 0, 1 ...
1st 15th

- (a) What is the 628th number?
(b) What is the sum of the first 627 numbers?

Ans: (a) _____ [1]

(b) _____ [3]

14. Susan bought some English books at \$14 each. She also bought an equal number of Chinese books at a different price. The average price of an English and a Chinese book was \$11. Susan paid \$30 more for the English books than the Chinese books.

- (a) What was the cost of a Chinese book?
- (b) How many English books did Susan buy?

Ans: (a) _____ [2]

(b) _____ [2]

15. Part of the schedule for the bus shuttle service from East Mall to and from View Mall is shown below.

Bus Leaves East Mall	Bus Arrives View Mall		Bus Leaves View Mall	Bus Arrives East Mall
10 55	11 15		11 20	11 40
11 45	12 05		12 10	12 30
12 35	12 55		13 00	13 20
13 25	13 45		13 50	14 10
14 15	14 35		14 40	15 00

Peter took the bus from East Mall to View Mall. Then he walked 10 minutes to reach John's house. He reached John's house at 12.15 p.m. Half an hour later, Peter and John decided to visit View Mall. They left View Mall in time for Peter to take the bus back to East Mall. Peter reached East Mall at 3 p.m.

- a) At what time did Peter take the bus from East Mall?
 b) How long did Peter and John spend at View Mall?

Ans: a) _____ [2]

b) _____ [2]

16. On Friday, Sean read $\frac{3}{7}$ of a storybook.
On Saturday, he read 28 pages of the book.
On Sunday, he read $\frac{2}{5}$ of the remaining book, leaving 36 pages unread.
- a) Find the number of pages read on Sunday.
- b) Find the total number of pages in the book.

Ans: (a) _____ [2]

(b) _____ [3]

17. Dawn had 3 times as many beads as toothpicks. After she used 186 beads and 27 toothpicks, there were twice as many toothpicks as beads.
- (a) How many beads did Dawn have in the end?
- (b) How many toothpicks did Dawn have at first?

Ans: (a) _____ [3]

(b) _____ [2]

End of Paper 2

SCHOOL : TAO NAN PRIMARY SCHOOL
 LEVEL : PRIMARY 5
 SUBJECT : MATH
 TERM : 2021 EOY

PAPER 1 BOOKLET A

Q1	Q2	Q3	Q4	Q5	Q6	Q7	Q8	Q9	Q10
2	3	3	1	3	4	3	3	1	4

Q11	Q12	Q13	Q14	Q15
4	2	1	1	3

PAPER 1 BOOKLET B

Q16)	H
Q17)	$70 + 2.3 = 72.3$
Q18)	$\frac{1}{6} + 1\frac{3}{4} = \frac{1}{6} + \frac{7}{4}$ $= \frac{2}{12} + \frac{21}{12}$ $= \frac{23}{12}$ $= 1\frac{11}{12}$
Q19)	No. of s Bala took = $48 + 3$ $= 51$ No. of s Carl took = $51 - 1$ $= 50$
Q20)	$12 \times 2 = 24$ Ans: September
Q21)	965203
Q22)	$\frac{1}{12}$ of the number = $15 \div 5$ $= 3$ $\frac{10}{12}$ of the number = 3×10 $= 30$

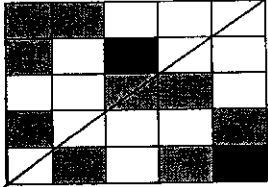
Q23)	<p>A:B 1:2 3:6</p> <p>B:C 3:4 6:8</p> <p>A:C 3:8</p>												
Q24)	<p>Amount of money saved = \$50 - \$35 = 15</p> <p>$\frac{15}{50} \times 100\% = 30\%$</p>												
Q25)	<p>1.6m = 160cm Sister's height = 160cm - 3cm = 157cm = 1.57m</p>												
Q26)													
Q27)	<p>1 min = 60s 60s → 450mℓ 20s → 450mℓ ÷ 3 = 150mℓ</p>												
Q28)	<p>$(3 \times 4) + (2 + 6) + 6 + (2 \times 3) = 32\text{cm}$</p>												
Q29)	<table border="1" style="margin-left: 20px;"> <tbody> <tr> <td>M</td> <td>U</td> <td></td> </tr> <tr> <td>Tue</td> <td>U</td> <td>\$0.50</td> </tr> <tr> <td>W</td> <td>U</td> <td>\$0.50 x 2</td> </tr> <tr> <td>Thu</td> <td>U</td> <td>\$0.50 x 3</td> </tr> </tbody> </table> <p style="margin-left: 20px;"> $4U = \\$9 - (\\$0.50 \times 6)$ $= \\$6$ $1U = \\$6 \div 4$ $= \\$1.50$ </p>	M	U		Tue	U	\$0.50	W	U	\$0.50 x 2	Thu	U	\$0.50 x 3
M	U												
Tue	U	\$0.50											
W	U	\$0.50 x 2											
Thu	U	\$0.50 x 3											
Q30)	4												

PAPER 2

Q1)	$1\frac{1}{10}\text{kg} \div 0.1\text{kg} = 11$ No. of 100g of squid bought = 11 Cost of $1\frac{1}{10}\text{kg}$ of squid = $11 \times \$1.68$ $= \$18.48$ $1\frac{1}{10}\text{kg}$ of squid cost \$18.48																				
Q2)	$\text{Angle } y = 180^\circ - 32^\circ - 77^\circ$ $= 71^\circ$																				
Q3)	<table border="1" data-bbox="347 725 624 1093"> <tbody> <tr><td>Fri</td><td>35min</td></tr> <tr><td>Sat</td><td>60min</td></tr> <tr><td>Sun</td><td>60min</td></tr> <tr><td>Mon</td><td>(35 x 5)</td></tr> <tr><td>Tue</td><td>min</td></tr> <tr><td>Wed</td><td></td></tr> <tr><td>Thu</td><td></td></tr> <tr><td>Fri</td><td></td></tr> <tr><td>Sat</td><td>120min</td></tr> <tr><td>Sun</td><td></td></tr> </tbody> </table> <p>7.5 hours = 7 hour 30 min = 450 min $450 - 35 - 60 - (35 \times 5) - 60 - 60 = 0$ (Sunday) Ans: Sunday</p>	Fri	35min	Sat	60min	Sun	60min	Mon	(35 x 5)	Tue	min	Wed		Thu		Fri		Sat	120min	Sun	
Fri	35min																				
Sat	60min																				
Sun	60min																				
Mon	(35 x 5)																				
Tue	min																				
Wed																					
Thu																					
Fri																					
Sat	120min																				
Sun																					
Q4)	Odd no. less than 40 = 1, 3, 5, 7, 9, 11, 13, 15, 17, 19, 21, 23, 25, 27, 29, 31, 33, 35, 37, 39 Total sum of all odd no. = 10 pairs of 40 $= 40 \times 10 = 400$ The sum of all odd numbers is 400.																				
Q5)	$\frac{1}{6}$ of rectangle A = $\frac{1}{4}$ of rectangle B (Making the numerator the same) Using the denominator: A : B : Shaded : Total 6 : 4 : 1 : 9 Fraction of figure not shaded in A = $\frac{6}{9} - \frac{1}{9}$ $= \frac{5}{9}$ Fraction of figure not shaded in B = $\frac{4}{9} - \frac{1}{9}$ $= \frac{3}{9}$ Fraction of figure not shaded = $\frac{5}{9} + \frac{3}{9}$ $= \frac{8}{9}$																				

	The fraction of the figure is $\frac{8}{9}$.				
Q6)	<p>2 mangoes + 1 durian = \$9.10 → (1) 1 mango + 2 durians = \$12.80 → (2) 2 mangoes + 4 durians = \$25.60 → (3)</p> <p>Cost of 3 durians = \$25.60 - \$9.10 = \$16.50 Cost of 1 durian = \$16.50 ÷ 3 = \$5.50 Cost of 1 mango = \$12.80 - (\$5.50 × 2) = \$1.80 Total cost of mango and durian = \$5.50 + \$1.80 = \$7.30 The total cost of manga and durian is \$7.30</p>				
Q7)	<p>No. of words typed in 16 mins = 16 × 90 = 1440</p> <p>1 set = 7 words No. of sets = 1440 ÷ 360 = 4 No. of words typed wrongly = 4 × 7 = 28 No. of words typed correctly = 1440 - 28 = 1412 1412 words are typed correctly in 16 mins.</p>				
Q8)	<p>Vol of 75% water = 140cm × 80cm × 120cm = 1344ℓ</p> <p>1344ℓ ÷ 3 = 448ℓ 1% of water = 1344000cm³ ÷ 75 = 17920cm³ 100% of water = 17920cm³ × 100 = 1792000cm³ = 1792ℓ Amount of water needed to fill the tank completely = 1792ℓ - 1344ℓ = 488ℓ 488ℓ of water is needed to fill the tank completely.</p>				
Q9)	<table border="1" style="width: 100%;"> <tr> <td>M of 7 →</td> <td>21, 28, 35, 43, <u>49</u>, 56</td> </tr> <tr> <td>M of 5 →</td> <td>20, 25, 30, 35, 40, 45, 50, 55, 60</td> </tr> </table> <p>Kai Xuan's age now = (50 - 1) = 49 Kai Xuan's age om 6 years time = 49 + 6 = 55 He will be 55 years old in 6 years time.</p>	M of 7 →	21, 28, 35, 43, <u>49</u> , 56	M of 5 →	20, 25, 30, 35, 40, 45, 50, 55, 60
M of 7 →	21, 28, 35, 43, <u>49</u> , 56				
M of 5 →	20, 25, 30, 35, 40, 45, 50, 55, 60				

Q10)	<p>Cost of laptop after discount = $\\$3600 \div 2$ $\\$1800$ $100\% - 25\% = 75\%$ 75% of original price of laptop = $\\$1800$ 5% of original price of laptop = $\\$1800 \div 15$ $= \\$120$ 100% of original price of laptop = $\\$120 \times 20$ $= \\$2400$ The original price of 1 laptop is $\\$2400$</p>																				
Q11)	<p>Area of figure = $(6 \times 6) + (3 \times 3) + (\frac{1}{2} \times 3 \times 3)$ $= 36 + 9 + 4.5$ $= 49.5\text{cm}^2$ Area of A = $\frac{1}{2} \times 6 \times 6$ $= 18\text{cm}^2$ Area of B = $\frac{1}{2} \times 9 \times 3$ $= 13.5\text{cm}^2$ $49.5\text{cm}^2 - 18\text{cm}^2 - 13.5\text{cm}^2 = 18\text{cm}^2$</p>																				
Q12)	<p>a)</p> <table border="1" data-bbox="336 992 1385 1137"> <thead> <tr> <th>Ratio</th> <th>Anne</th> <th>Ming</th> <th>Shanta</th> <th>Total</th> </tr> </thead> <tbody> <tr> <td>Before</td> <td>10</td> <td>5</td> <td>3</td> <td>18</td> </tr> <tr> <td>Change</td> <td>- 68</td> <td>+ ?</td> <td>+ ?</td> <td></td> </tr> <tr> <td></td> <td>6</td> <td>6</td> <td>6</td> <td>18</td> </tr> </tbody> </table> <p>$18 \div 3 = 6$ A:M:S 6 : 6 : 6 1 : 1 : 1</p> <p>b)</p> <p>$10U - 6U = 4U$ $4U = 68$ $1U = 68 \div 4$ $= 17$ $18U = 17 \times 18$ $= 306$ The total number of sweets the children had is 306.</p>	Ratio	Anne	Ming	Shanta	Total	Before	10	5	3	18	Change	- 68	+ ?	+ ?			6	6	6	18
Ratio	Anne	Ming	Shanta	Total																	
Before	10	5	3	18																	
Change	- 68	+ ?	+ ?																		
	6	6	6	18																	
Q13)	<p>a)</p> <p>$628 \div 4 = 157$ 628^{th} number = 2</p> <p>b)</p> <p>Sum of 1 set = $4 + 0 + 1 + 2$ $= 7$ No. of sets = $627 \div 4$ $= 156\text{R}3$ $156 \times 7 = 1092$ $1092 + 4 + 0 + 1 = 1097$</p>																				

Q14)

a)

$$\begin{aligned} \text{Cost of a english and chinese book} &= \$11 \times 2 \\ &= \$22 \end{aligned}$$

$$\begin{aligned} \text{Cost of a chinese book} &= \$22 - \$14 \\ &= \$8 \end{aligned}$$

The cost of a chinese book is \$8.

b)

E	\$6
C	

$$\begin{aligned} \text{Dif. Of 1 set} &= \$14 - \$8 \\ &= \$6 \end{aligned}$$

$$\begin{aligned} \text{No. of sets} &= \$30 \div \$6 \\ &= 5 \end{aligned}$$

No. of English books Susan bought = 5
Susan bought 5 English books.

Q15)

a)

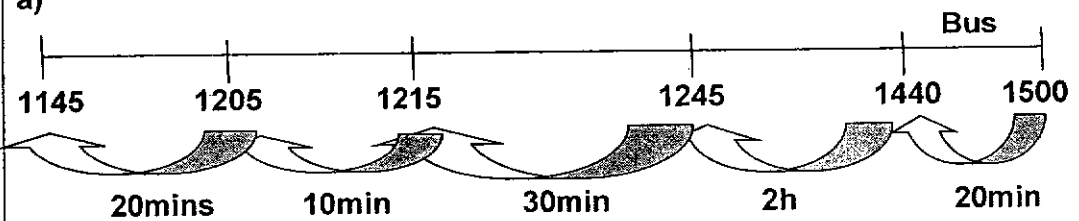

He took the bus from East Mall at 11.45pm.

b)

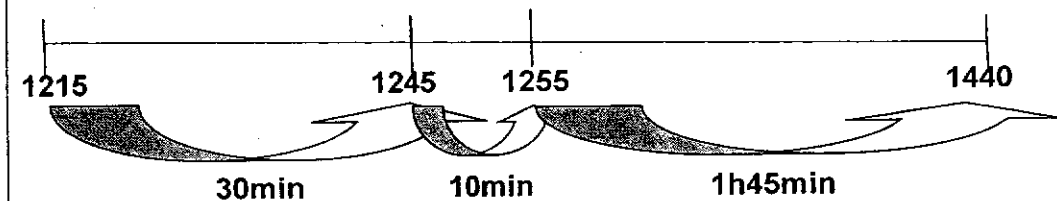

Peter and John spent 1h 45min at View Mall.

Q16)

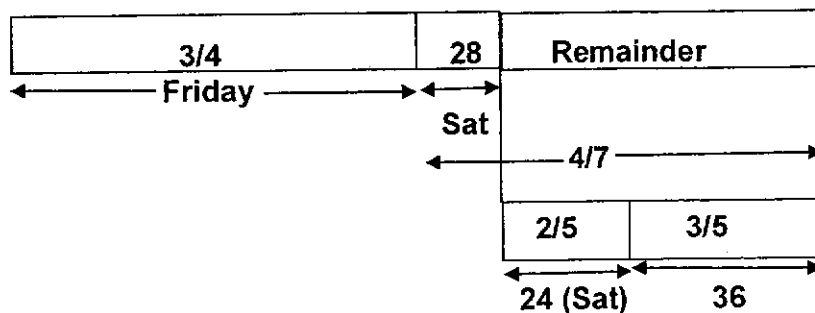

a)

$$\frac{3}{5} \text{ of remainder} = 36$$

$$\frac{1}{5} \text{ of remainder} = 36 \div 3 \\ = 12$$

$$\frac{2}{5} \text{ of remainder} = 12 \times 2 \\ = 24$$

No. of pages read on Sunday = 24

The number of pages read on Sunday is 24.

b)

$$\frac{5}{5} \text{ of remainder} = 12 \times 5 \\ = 60$$

$$\frac{4}{7} \text{ of remainder} = 60 + 28 \\ = 88$$

$$\frac{1}{7} \text{ of remainder} = 88 \div 4 \\ = 22$$

$$\frac{7}{7} \text{ of remainder} = 22 \times 7 \\ = 154$$

The total no. of pages in the book is 154.

Q17

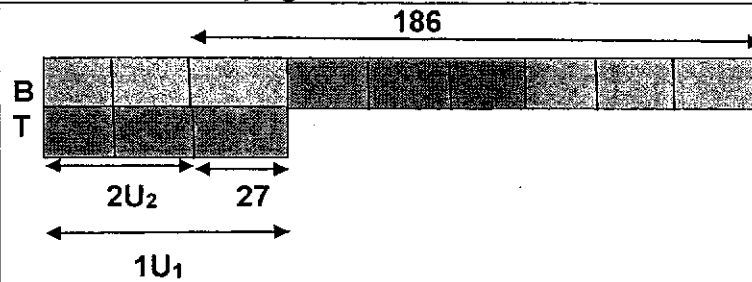

a)

$$186 - (27 \times 3) = 105$$

$$105 \div 5 = 21$$

b)

$$21 \times 2 + 27 = 69$$

