

HENRY PARK PRIMARY SCHOOL
2021 END-OF-YEAR EXAMINATION
MATHEMATICS
PRIMARY 5

PAPER 1
(BOOKLET A)

Name: _____ ()

Parent's Signature

Class: Primary 5 _____

Marks:

Paper 1	Booklet A	20
	Booklet B	25
Paper 2		55
Total		100

Total Time for Booklets A and B: 1 hour

Do not turn over this page until you are told to do so.

Follow all instructions carefully.

Answer all questions.

Shade your answers in the Optical Answer Sheet (OAS) provided.

You are **not** allowed to use a calculator.

Questions 1 to 10 carry 1 mark each. Questions 11 to 15 carry 2 marks each.
For each question, four options are given. One of them is the correct answer.
Make your choice (1, 2, 3 or 4) and shade your answer in the Optical Answer Sheet.

(20 marks)

1 What is the value of the digit 9 in the number 493 572?

- (1) 90
- (2) 900
- (3) 9000
- (4) 90 000

2 Find the value of $80 \div 400$

- (1) 0.02
- (2) 0.2
- (3) 5
- (4) 50

3 The opening hours of a bakery are shown below. How long is the bakery open each day?

- (1) 6 h 15 min
- (2) 6 h 45 min
- (3) 7 h 15 min
- (4) 7 h 45 min



- 4 Jack had \$200. He spent 75% of his money. How much money did he spend?
- (1) \$25
 - (2) \$50
 - (3) \$125
 - (4) \$150
- 5 After giving away 90 cupcakes, Mrs Chua was left with $\frac{2}{5}$ of her cupcakes. How many cupcakes did she have left?
- (1) 36
 - (2) 60
 - (3) 135
 - (4) 225
- 6 Michelle has 84 red and blue buttons in total. She has 12 blue buttons. What is the ratio of the number of blue buttons to the number of red buttons that Michelle has?
- (1) 1 : 6
 - (2) 1 : 7
 - (3) 6 : 1
 - (4) 7 : 1
- 7 A printer can print 40 posters in 2 minutes. At this rate, how many posters can the printer print in an hour?
- (1) 1200
 - (2) 2000
 - (3) 2400
 - (4) 4000

- 8 A figure is drawn on the square grid shown.

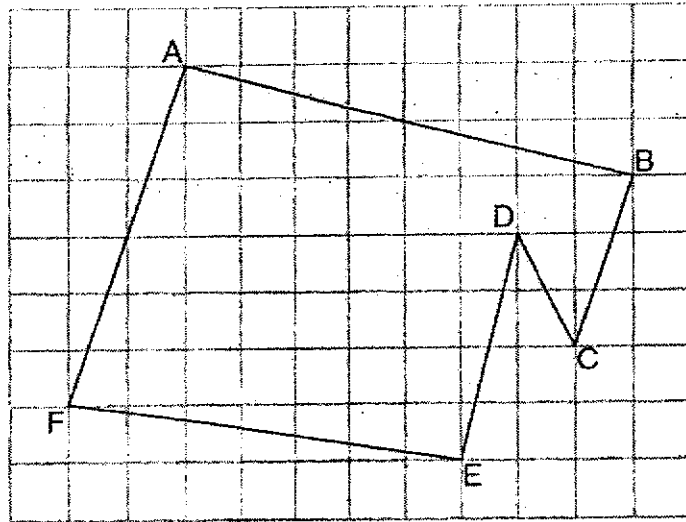

Which one of the following statements is true?

- (1) AF is perpendicular to AB
 (2) AF is perpendicular to EF
 (3) AF is parallel to ED
 (4) AF is parallel to BC
- 9 In the number line below, what is the mixed number represented by X?

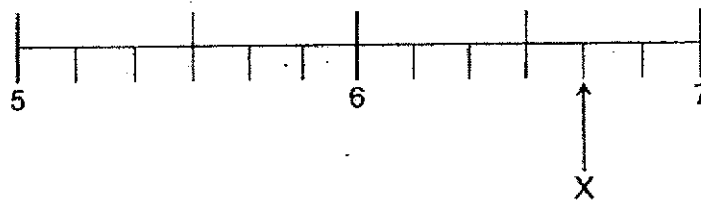

- (1) $6\frac{2}{3}$
 (2) $6\frac{3}{4}$
 (3) $6\frac{3}{5}$
 (4) $6\frac{4}{5}$

Use the information below to answer Questions 10 and 11.

The graph below shows the number of pens sold at a shop in each month from January to June. The bar for the month of June has not been drawn.

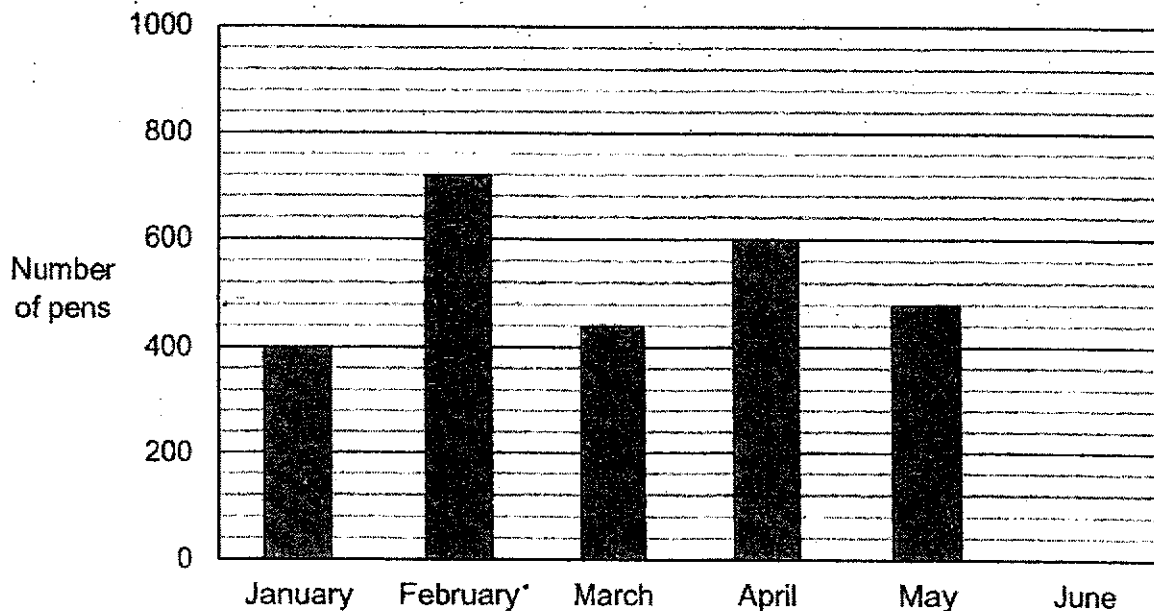

- 10 The shop sold twice as many pens in June as May. How many pens did the shop sell in June?
- (1) 240
 (2) 840
 (3) 880
 (4) 960
- 11 What is the average number of pens sold in each month from January to April?
- (1) 520
 (2) 528
 (3) 540
 (4) 600

- 12 In the figure, AB and CD are straight lines. Find $\angle p$.

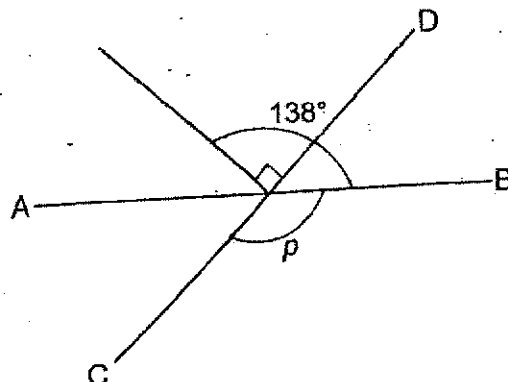

- (1) 42°
(2) 48°
(3) 87°
(4) 132°
- 13 At a party, the ratio of the number of adults to the number of children is 7 : 3. Given that there are 56 adults, how many more adults than children were there?
- (1) 24
(2) 32
(3) 60
(4) 80

- 14 The solids below are made up of unit cubes. How many more unit cubes are used to form solid B than solid A?

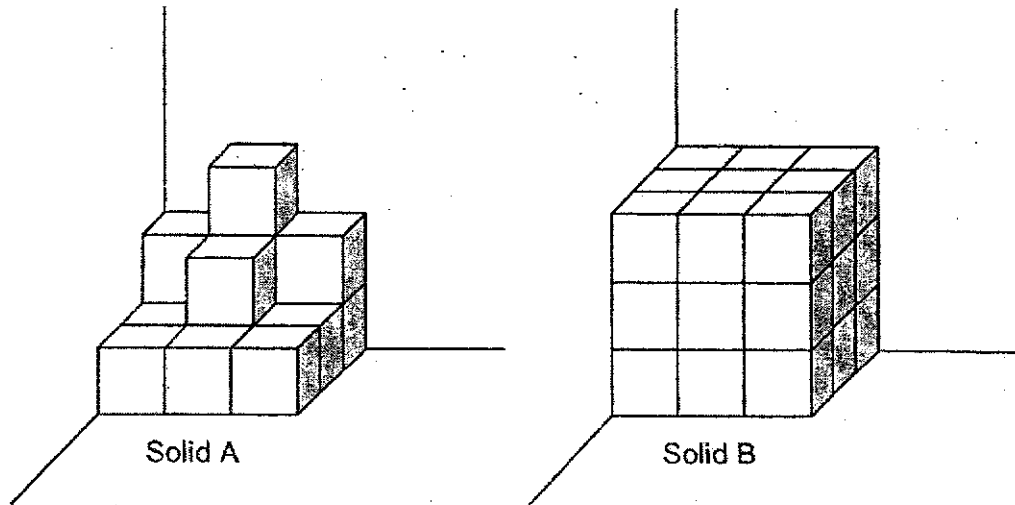

- (1) 12
 (2) 13
 (3) 14
 (4) 27
- 15 Andy had a number of oranges. He could pack all his oranges equally into 25 boxes. If he packed 3 fewer oranges in each box, he would be able to pack all his oranges equally into 30 boxes. How many oranges did Andy have altogether?

- (1) 90
 (2) 375
 (3) 450
 (4) 540



HENRY PARK PRIMARY SCHOOL
2021 END-OF-YEAR EXAMINATION
MATHEMATICS
PRIMARY 5

PAPER 1
(BOOKLET B)

Name: _____ ()

Class: Primary 5

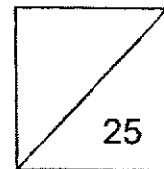

Total Time for Booklets A and B: 1 hour

Do not turn over this page until you are told to do so.

Follow all instructions carefully.

Answer all questions.

Write your answers in this booklet.

You are **not** allowed to use a calculator.

Questions 16 to 20 carry 1 mark each. Write your answers in the spaces provided.
For questions which require units, give your answers in the units stated.

(5 marks)

Do not write
in this space

16 Find the value of $\frac{3}{8} - \frac{1}{6}$.

Ans: _____

17 Find the value of $14.21 \div 7$

Ans: _____

18 Find the value of $16 - 72 \div 8 + (21 - 15)$

Ans: _____

- 19 Write down all the common factors of 12 and 40.

Do not write
in this space

Ans: _____

- 20 What is the missing number in the box?

$$15 : 45 = 4 : \boxed{?}$$

Ans: _____

Questions 21 to 30 carry 2 marks each. Show your working clearly and write your answers in the spaces provided. For questions which require units, give your answers in the units stated.

Do not write in this space

(20 marks)

- 21 (a) In the figure, A, B and C are three points on a map. Point B is north of point C. In what direction is point B from point A?

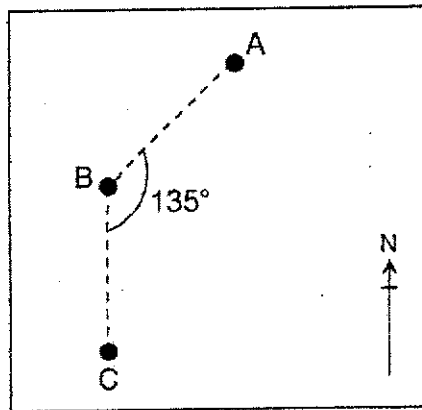

Ans: (a) _____

- (b) Complete the drawing of the symmetric figure with XY as the line of symmetry.

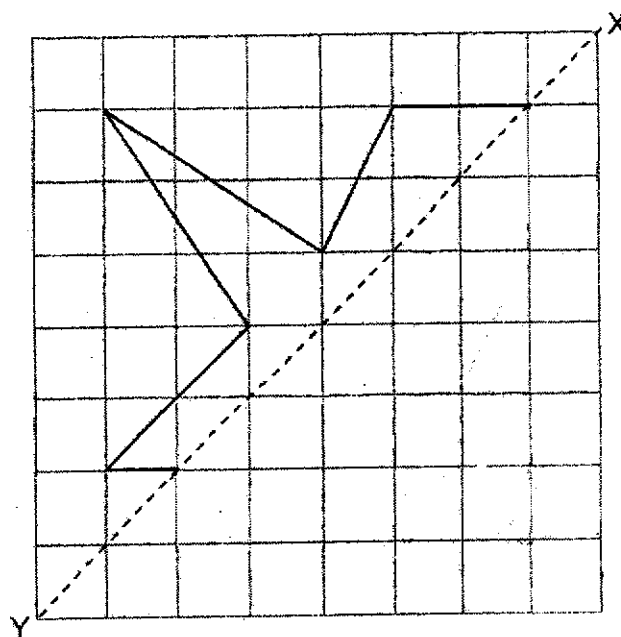

- 22 A car needs 7 litres of petrol to travel a distance of 56 km. At this rate, how much petrol does the car need to travel a distance of 144 km?

Do not write
in this space

Ans: _____ litres

- 23 Express $\frac{5}{9}$ as a decimal. Give your answer correct to 2 decimal places.

Ans: _____

24 Find the area of the shaded triangle.

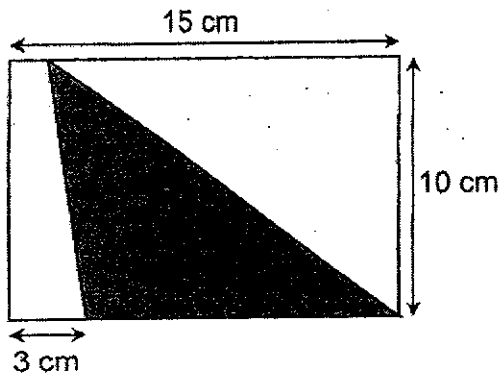

Do not write in this space

Ans: _____ cm²

25 The solid below is made up of 6 cubes.

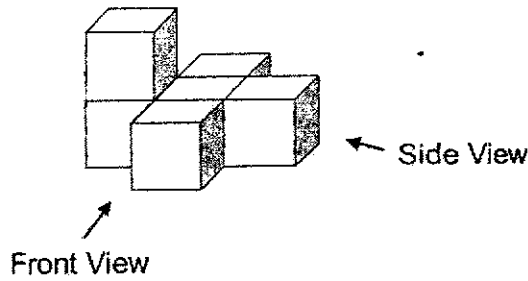

Draw the side view and the front view of the solid on the grid below.

Front View

Side View

- 26 In the figure, ABK and PQR are equilateral triangles. Find $\angle BKQ$.

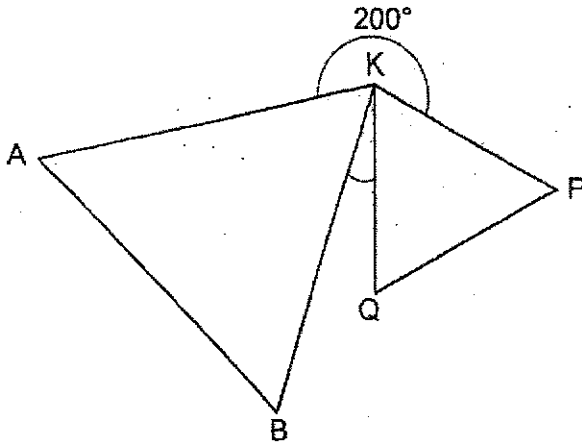

Do not write in this space

Ans: _____ °

- 27 The figure below is made up of 2 rectangles. The ratio of the area of the large rectangle to that of the small rectangle is 5 : 3. Find the area of the unshaded part of the figure.

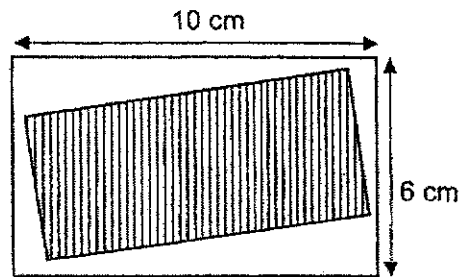

Ans: _____ cm²

- 28 In the figure, ABC is an isosceles triangle where $AB = AC$. ACE and BCD are straight lines. Given that $\angle DCE = 55^\circ$, find $\angle BAC$.

Do not write
in this space

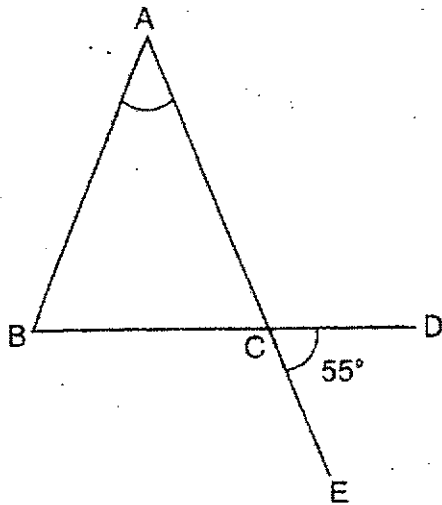

Ans: _____^o

- 29 The figure below is made up of 3 squares. The sides of the squares measure 4 cm, 5 cm and 6 cm. Find the perimeter of the figure.

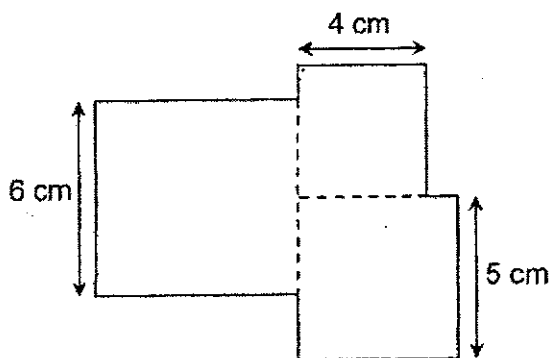

Ans: _____ cm

- 30 $\frac{5}{9}$ of the fruits in a basket are apples and the rest are pears. $\frac{3}{10}$ of the apples are green apples. There are 21 green apples. How many fruits are there in the basket altogether?

Do not write
in this space

Ans: _____



HENRY PARK PRIMARY SCHOOL
2021 END-OF-YEAR EXAMINATION
MATHEMATICS
PRIMARY 5

PAPER 2

Name: _____ ()

Class: Primary 5

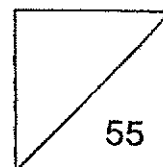

Time for Paper 2: 1 h 30 min

Do not turn over this page until you are told to do so.

Follow all instructions carefully.

Answer all questions.

Show your working clearly as marks are awarded for correct working.

Write your answers in this booklet.

You are allowed to use a calculator.

Questions 1 to 5 carry 2 marks each. Show your working clearly and write your answers in the spaces provided. For questions which require units, give your answers in the units stated.

(10 marks)

Do not write
in this space

- 1 Amy has some blue, yellow and orange marbles. $\frac{1}{6}$ of her marbles are blue. $\frac{1}{3}$ of her remaining marbles are yellow and the rest are orange. What fraction of her marbles are orange?

Ans: _____

- 2 A cubical container is filled with water to a height of 16 cm as shown below. How much more water is needed to fill the container to the brim? Express your answer in litres.

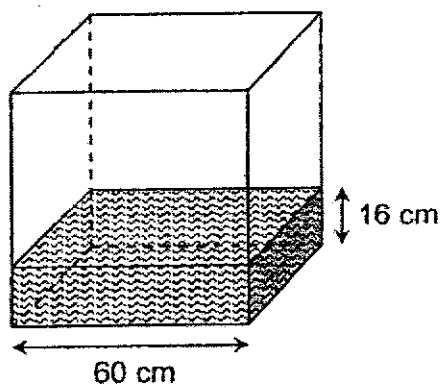

Ans: _____ litres

- 3 In the figure, ABCD is a rectangle where AC and BD are straight lines. Given that $\angle AEB = 130^\circ$ and $AE = EC = DE = EB$, find $\angle ADB$.

Do not write in this space

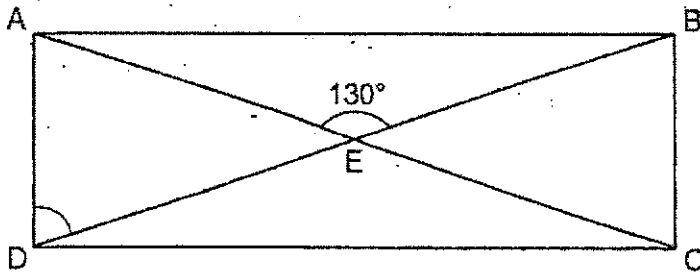

Ans: _____

- 4 Li Wen used some toothpicks and 35 stars to form a figure that follows a repeated pattern as shown below. How many toothpicks did he use to form the figure?



Ans: _____

- 5 Jane, Kelly and Lina had a sum of money. Jane and Kelly had \$212 altogether. Kelly and Lina had \$334 altogether. The amount that the three girls had in total was 6 times the amount that Kelly had. How much did Kelly have?

Do not write
in this space

Ans: \$ _____

For questions 6 to 17, show your working clearly and write your answers in the spaces provided. The number of marks available is shown in the brackets [] at the end of each question or part-question.

Do not write
in this space.

(45 marks)

- 6 The table below shows the parking charges at a carpark.

Parking Charges	
For the first hour	\$1.70
For every additional $\frac{1}{2}$ h	\$0.90

- (a) Mrs Tan paid \$3.50 for her parking charges. What was the longest possible duration she could have parked her car?
- (b) Mrs Lee parked her car from 9 a.m. to 1.30 p.m. How much did she pay for her parking charges?

Ans: (a) _____ [1]

(b) _____ [2]

7 Elaine baked a total of 425 chocolate and vanilla cupcakes. After she sold 85 vanilla cupcakes, the ratio of the number of chocolate cupcakes to the number of vanilla cupcakes left was 4 : 1.

Do not write
in this space

- (a) How many vanilla cupcakes did Elaine have left?
- (b) What percentage of the cupcakes that she baked were chocolate cupcakes?

Ans: (a) _____ [2]

(b) _____ [2]

- 8 Ivan has some black and white marbles. The total mass of all his marbles is 231 g. He has 3 more white than black marbles. The average mass of the black marbles is 8 g. The average mass of the white marbles is 9 g. How many marbles does Ivan have altogether?

Do not write
in this space

Ans: _____ [3]

9

In the figure below, ABCD is a rectangle and BDE is an isosceles triangle. Given that $BD = BE$, $\angle BED = 55^\circ$ and $\angle ADE = 253^\circ$, find $\angle DBC$.

Do not write
in this space

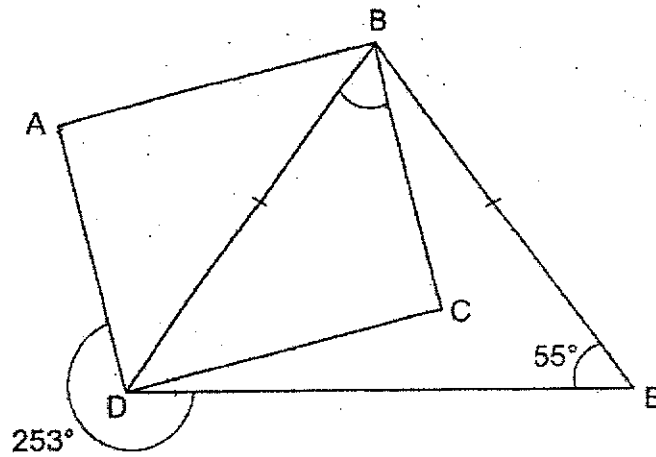

Ans: _____ [3]



- 10 The graph below shows the number of books loaned out each year by a school library from 2014 to 2018.

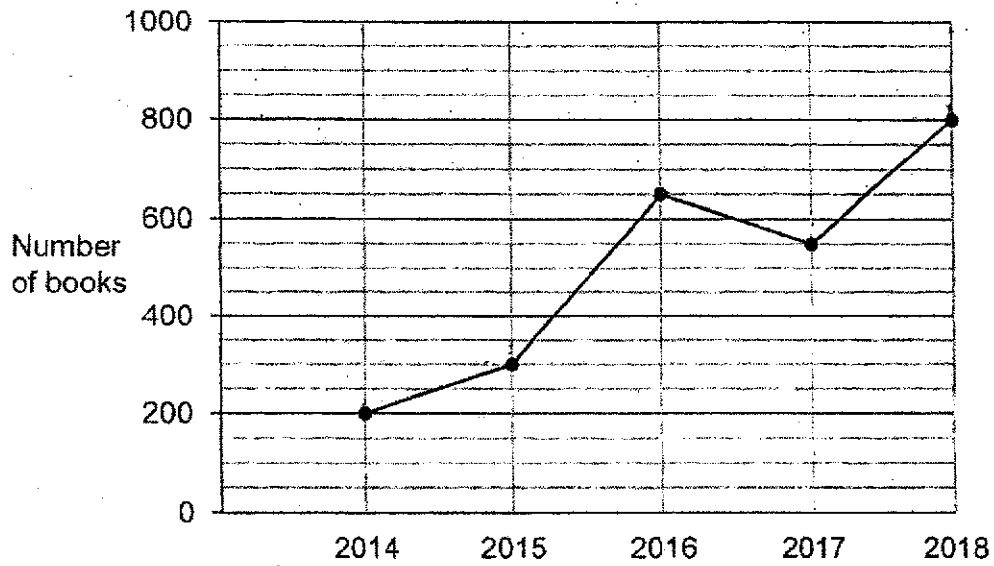

The average number of books loaned out each year by the school library from 2014 to 2020 is 450. Find the possible numbers of books loaned out in 2019 and 2020

Ans: _____ and _____ [3]

- 11 Kenji had some money. He spent $\frac{1}{6}$ of his money on food and \$180 on transport. He spent $\frac{2}{5}$ of the remaining money on a new watch. In the end, he had \$2730 left.

Do not write
in this space

- (a) What was the cost of the new watch?
(b) How much money did Kenji spend on food?

Ans: (a) _____ [2]

(b) _____ [3]

- 12 There are some \$2 and \$5 notes in a box. There are thrice as many \$2 notes as \$5 notes. Given that the total amount of money in the box is \$2255, how many \$2 notes are there in the box?

Do not write
in this space

Ans: _____ [3]

- 13 At a shop, sofa sets and dining chairs were sold at the prices shown.

Do not write
in this space

Sofa Sets

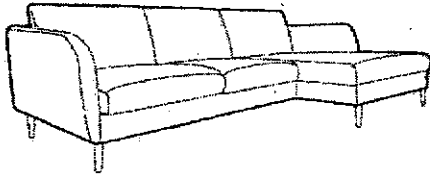

Usual Price: \$1978 each

Dining Chairs



Usual Price: \$65 each

- (a) Mrs Ang bought a sofa set at a discount of 35%. How much was the discount?
- (b) Mr Abdul bought some dining chairs at a discount of 20%. He paid \$416 in total. How many dining chairs did he buy?

Ans: (a) _____ [1]

(b) _____ [2]

- 14 Yan Ting and Emily bought sandwiches at the prices shown below.

Salmon Sandwiches

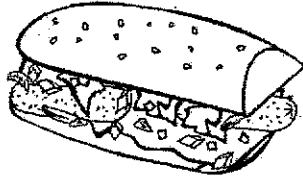

\$9.60 each

Tuna Sandwiches

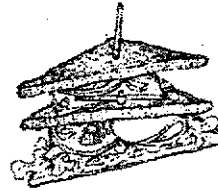

\$6.40 each

Do not write
in this space

- (a) Yan Ting spent \$464 on some salmon and tuna sandwiches. She bought 15 more salmon than tuna sandwiches. How many tuna sandwiches did Yan Ting buy?
- (b) Emily spent an equal amount of money on the salmon and tuna sandwiches. What fraction of the sandwiches Emily bought were salmon sandwiches?

Ans: (a) _____ [3]

(b) _____ [2]

- 15 Peter had a square piece of paper. He cut it along the dotted lines as shown in Figure 1 to get one small square of side 2 cm and four identical right-angled triangles. One such triangle is shown in Figure 2. Find the perimeter of the square piece of paper in Figure 1 before it was cut.

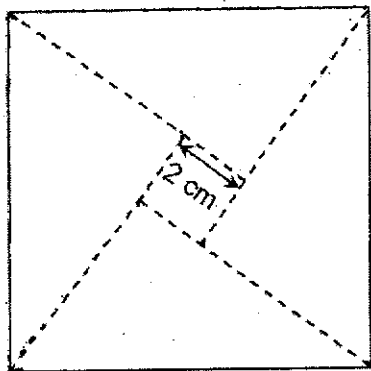

Figure 1

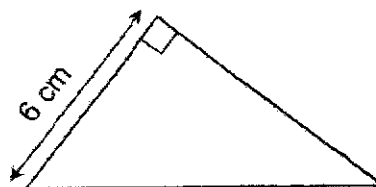

Figure 2

Do not write
in this space

Ans: _____ [4]



- 16 At first, Foo, Garrett and Hong had the same amount of money.
- After Hong spent some of his money, Foo spent $\frac{2}{5}$ of his money and Garrett spent $\frac{3}{4}$ of his money, Foo had \$238 more than Garrett.
- In the end, the total amount of money the three boys had left was \$703.
- How much money did Hong spend?

Do not write
in this space

Ans: _____ [4]

17 The first four figures of a pattern are shown below.

Do not write in this space

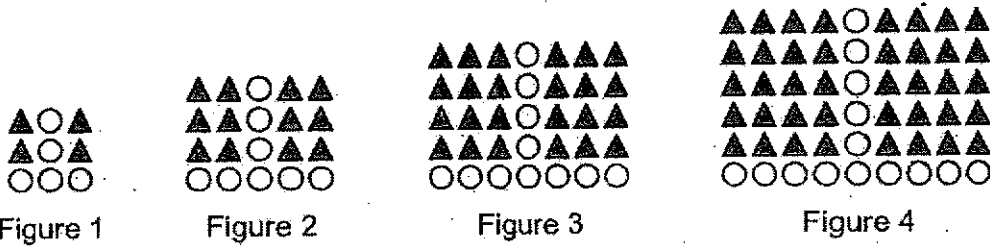

The table below shows the number of circles and triangles used in each figure.

Figure Number	Figure 1	Figure 2	Figure 3	Figure 4	Figure 5
Number of circles	5	8	11	14	
Number of triangles	4	12	24	40	

[1]

- (a) Fill in the table for Figure 5.
- (b) How many circles are there in Figure 39?
- (c) How many triangles are there in Figure 60?

Ans: (b) _____ [2]

(c) _____ [2]



SCHOOL : HENRY PARK PRIMARY SCHOOL
 LEVEL : PRIMARY 5
 SUBJECT : MATH
 TERM : 2021 EOYs

PAPER 1 BOOKLET A

Q 1	Q2	Q3	Q4	Q5	Q6	Q7	Q8	Q9	Q10
4	2	3	4	2	1	1	4	1	4

Q 11	Q12	Q13	Q14	Q15
3	4	2	2	3

PAPER 1 BOOKLET B

Q16)	$\frac{3}{8} - \frac{1}{6} = \frac{9}{24} - \frac{4}{24}$ $= \frac{5}{24}$
Q17)	2.03
Q18)	$16 - 72 \div 8 + (21 - 15) = 16 - 72 \div 8 + 6$ $= 16 - 9 + 6$ $= 9 + 6$ $= 13$
Q19)	1, 2, 4
Q20)	15:45 3 : 9 1 : 3 4 :12
Q21a)	South-East
Q21b)	

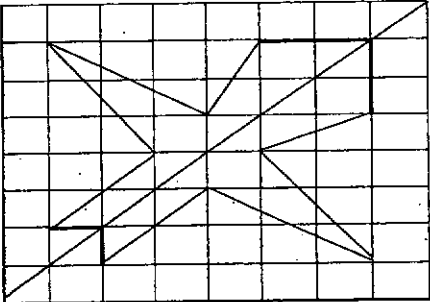
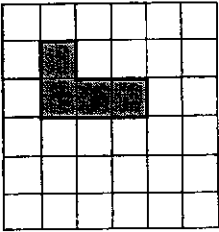
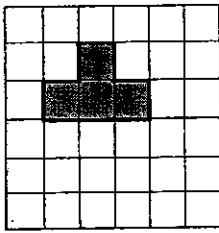
	
Q22)	$1\ell \text{ of petrol} = 56 \div 7$ $= 8$ $144 \div 8 = 18\ell$
Q23)	$5 \div 9 = 0.56$
Q24)	$15 - 3 = 12$ $\frac{1}{2} \times 12 \times 10 = 60\text{cm}^2$
Q25)	<p>Front View</p>  <p>Side View</p> 
Q26)	$360^\circ - 60^\circ - 60^\circ = 240$ $240^\circ - 200^\circ = 40^\circ$
Q27)	$10 \times 6 = 60$ $60 \div 5 = 12$ $12 \times 2 = 24\text{cm}^2$
Q28)	$55^\circ \times 2 = 110$ $180^\circ - 110^\circ = 70^\circ$
Q29)	$5 - 4 = 1$ $9 - 6 = 3$ $6 + 6 + 6 + 3 + 5 + 5 + 4 + 4 = 40$
Q30)	<p>If $\frac{5}{9}$ of the fruits in a basket are apples, $\frac{4}{9}$ of the fruits would be pears.</p>

$\frac{1}{3}$ of the apples $\rightarrow 21 \div 3 = 7$ $\frac{10}{10}$ of the apples $\rightarrow 7 \times 10 = 70$ $\frac{4}{9}$ of the fruits = 70 $\frac{1}{9}$ of the fruits = $70 \div 5$ $= 14$ $\frac{9}{9}$ of the fruits = 14×9 $= 126$
--

PAPER 2

Q1)	$\frac{2}{3} \times \frac{5}{6} = \frac{5}{9}$								
Q2)	$60 - 16 = 44$ $44 \times 60 \times 60 = 158400$ $158400\text{m}\ell = 158.4\ell$								
Q3)	$360^\circ - (130^\circ \times 2) = 100^\circ$ $100^\circ \div 2 = 50^\circ$ $160^\circ - 50^\circ = 110^\circ$ $130^\circ \div 2 = 65^\circ$								
Q4)	$35 - 1 = 34$ $34 \times 5 = 170$ $170 + 1 = 171$								
Q5)	<p>JKL <table border="1" style="display: inline-table; vertical-align: middle;"><tr><td> </td><td> </td><td> </td><td> </td><td> </td><td> </td><td> </td></tr></table></p> <p>K <table border="1" style="display: inline-table; vertical-align: middle;"><tr><td> </td></tr></table></p> <p>$\\$334 - \\$212 = \\$122$ June + 2 Kelly + Lina = $\\$212 + \\334 = $\\$547$ $\\$547 \div 7 = \\78</p>								
Q6)	<p>a) First hour $\rightarrow 3.50 - 1.70 = 1.80$ $1.80 \div 0.90 = 2$ 1 hour + 1 hour = 2 hours</p> <p>b)</p> <p>$\\$0.90 \times 7 = \\6.30 $\\$6.30 + \\$1.70 = \\$8$</p>								

Q7)	<p>a)</p> $425 - 45 = 340$ $340 \div (4 + 1) = 68$ <p>b)</p> $68 \times 4 = 272$ $\frac{272}{425} \times \frac{100}{1} = 64\%$
Q8)	$(8 \times 12) + (9 \times 15) = 231$ $12 + 15 = 27 \text{ marbles}$
Q9)	$360^\circ - (253 + 55)^\circ = 52^\circ$ $(55 + 52)^\circ - 90^\circ = 17^\circ$ $180^\circ - 52^\circ - 40^\circ = 38^\circ$ $90^\circ - 38^\circ = 52^\circ$
Q10)	$200 + 300 + 650 + 550 + 800 = 2500$ $450 \times 7 = 3150$ $3150 - 2500 = 650$ $500 + 150 = 650$ <p>Ans: 500 and 150</p>
Q11)	<p>a)</p> $\frac{3}{5} \rightarrow 2730$ $\frac{1}{5} \rightarrow 2730 \div 3$ $= 910$ $910 \times 2 = \$1820$ <p>b)</p> $(1820 + 2730 + 180) \div 5 = \946
Q12)	$(2 \times 615) + (5 \times 205) = 2255$ <p>Ans: 615 notes</p>
Q13)	<p>a)</p> $\frac{35}{100} \times 1978 = \692.30 <p>b)</p> $\frac{80}{100} \times 65 = 52$ $416 \div 52 = 8$
Q14)	<p>a)</p> $464 - (960 \times 15) = 320$ $320 \div (9.60 + 6.40) = 20$ <p>b)</p> <p>common multiples of \$9.60 and \$6.40</p> <p>9.60, 19.20... (2 salmon)</p> <p>6.40, 12.80, 19.20... (3 tuna)</p>

	Ans: $\frac{2}{5}$
Q15)	$\frac{1}{2} \times 6 \times 8 = 24$ $24 \times 4 = 96$ $2 \times 2 = 4$ $96 + 4 = 100$ $10 \times 10 = 100$ $10 + 10 + 10 + 10 = 40$
Q16)	<p>Amount spent</p> <p>F : G</p> $\frac{2}{5} : \frac{3}{4}$ 8 : 15 $15U - 8U = 7$ $7U = 238$ $1U = 238 \div 7$ = 34 $34 \times 17 = 578$ $703 - 578 = 125$ $34 \times 20 = 680$ $680 - 125 = \$555$
Q17)	<p>a)</p> <p>Number of circles: 17</p> $6 \times 5 = 30$ $30 \times 2 = 60$ <p>Number of triangles: 60</p> <p>b)</p> $5 + 3 + 3 + 3 \dots + 3 = 119$ <p>c)</p> $2 + 59 = 61$ $61 - 1 = 60$ $60 \times 61 \times 2 = 7320$

