



RED SWASTIKA SCHOOL

RED SWASTIKA SCHOOL

2015 SEMESTRAL ASSESSMENT 2

MATHEMATICS PAPER 1

Name : _____ ()

Class : Primary 5 / _____

Date : 20 Oct 2015

BOOKLET A

15 Questions

20 Marks

Duration of Paper 1 (Booklets A & B): 50 minutes

Note:

1. Do not open this Booklet until you are told to do so.
2. Read carefully the instructions given at the beginning of each part of the Booklet.
3. Do not waste time. If a question is difficult for you, go on to the next one.
4. Check your answers thoroughly and make sure you attempt every question.
5. In this booklet, you should have the following:
 - (a) Page 1 to Page 4
 - (b) Questions 1 to 15
6. You are not allowed to use a calculator.

Questions 1 to 10 carry 1 mark each. Questions 11 to 15 carry 2 marks each. For each question, four options are given. One of them is the correct answer. Make your choice (1, 2, 3 or 4). Shade the correct oval (1, 2, 3 or 4) on the Optical Answer Sheet. (20 marks)

1 $4\,379\,700 = 4\text{ millions} + 372\text{ thousands} + \boxed{}$ hundreds

What is the missing number in the box?

- (1) 7
- (2) 70
- (3) 77
- (4) 700

2 Mdm Aminah bought 3 kg of crabs. She cooked $\frac{2}{5}$ of it. How many kilograms of crabs were left?

- (1) $1\frac{1}{5}$ kg
- (2) $1\frac{4}{5}$ kg
- (3) $2\frac{3}{5}$ kg
- (4) $3\frac{2}{5}$ kg

3 3 hundreds, 5 tenths and 6 thousandths is _____.

- (1) 350.006
- (2) 300.650
- (3) 300.506
- (4) 300.056

4 Arrange the following numbers from the largest to the smallest.

8, 8.1, 8.01

- (1) 8, 8.01, 8.1
- (2) 8.1, 8, 8.01
- (3) 8.1, 8.01, 8
- (4) 8.01, 8.1, 8

5 The perimeter of a rectangular piece of greeting card is 72 cm. Its breadth is 15 cm. Find the length of the card.

- (1) 42 cm
- (2) 36 cm
- (3) 29 cm
- (4) 21 cm

6 The area of the triangle is _____ cm^2 .

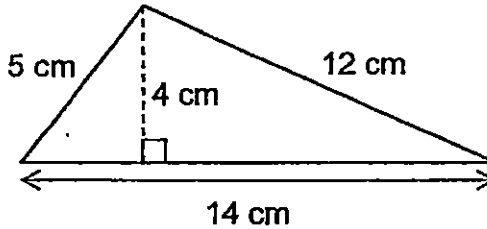

- (1) 10
- (2) 28
- (3) 30
- (4) 35

7 Which of the following shapes can be tessellated?

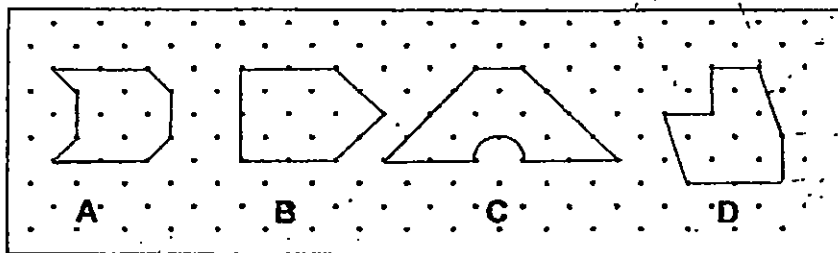

- (1) A and B only
- (2) A and C only
- (3) A and D only
- (4) A, B and D only

8 Mr Rahim bought 11 grapefruits and 22 pears. Find the ratio of the number of grapefruits to the total number of fruits bought.

- (1) 1 : 2
- (2) 1 : 3
- (3) 2 : 3
- (4) 3 : 2

9 In a class of 50 students, 20% of them are left-handed. How many students are right-handed?

- (1) 10
- (2) 20
- (3) 30
- (4) 40

10 Bala rented a bicycle from 16 30 to 18 00. If he was charged \$5 every 30 min, how much would he need to pay?

- (1) \$5
- (2) \$10
- (3) \$15
- (4) \$20

11 The ratio of $\angle x$ to $\angle y$ to $\angle z$ is 2 : 3 : 5. Find $\angle z$.

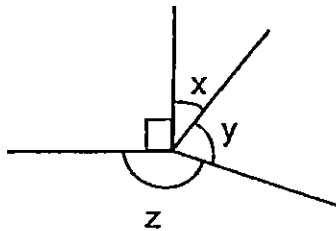

- (1) 27°
- (2) 90°
- (3) 135°
- (4) 165°

12 A shopkeeper had 24 trays of eggs. There were 36 eggs in each tray. He broke 38 eggs and sold 594 of them. How many eggs did he have left?

- (1) 216
- (2) 232
- (3) 350
- (4) 826

13 Alice cut 9.25 m of string from a ball of string. Siti cut a length of 3.6 m longer than Alice from the same ball of string. If the remaining length of string in the ball was twice the total length cut by Alice and Siti, what was the original length of the string in the ball before it was cut?

- (1) 22.1 m
- (2) 38.55 m
- (3) 44.7 m
- (4) 66.3 m

14 What is the maximum number of 2-cm cubes that can fit into a box 10 cm by 8 cm by 7 cm?

- (1) 40
- (2) 50
- (3) 60
- (4) 70

15 The figure below is made up of two triangles. What is the value of $\angle a + \angle b + \angle c + \angle d$?

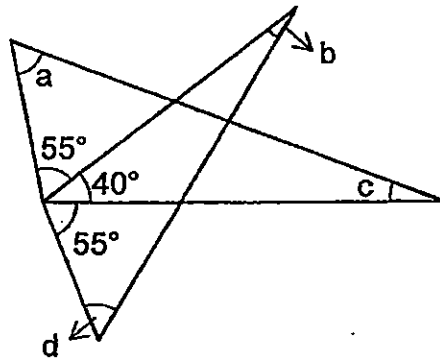

- (1) 150°
- (2) 170°
- (3) 190°
- (4) 210°

Questions 16 to 25 carry 1 mark each. Write your answers in the spaces provided. For questions which require units, give your answers in the units stated. (10 marks)

16 What is the missing number in the box?

$$624 \div 16 = 624 \div 2 \div \boxed{}$$

Ans: _____

17 Find the value of $24 - (11 + 5) \div 4 \times 2$.

Ans: _____

18 Round off the sum of 8.43 and 12.95 to 1 decimal place.

Ans: _____

19 What is the missing number in the box?

$$14.907 = 10 + 4 + \boxed{} + \frac{7}{1000}$$

Ans: _____

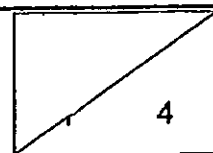

- 20 A movie started at 23 15 and ended at 01 05. How long did the movie last? Express your answer in hours and minutes.

Ans: _____ h _____ min

- 21 Muthu's height is 1.58 m. Yixiong is 15 cm taller than Muthu. What is Yixiong's height in metres?

Ans: _____ m

- 22 Name the letters which have parallel lines.

M A T H

Ans: _____ and _____

- 23 The shaded area of one face of a cube is 49 cm^2 . Find the volume of the cube.

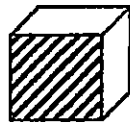

Ans: _____ cm^3

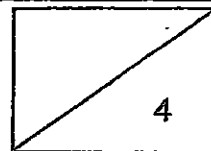

- 24 In the figure below, not drawn to scale, PQRS is a rectangle and the length of QR is twice the length of SR. Find the area of the shaded triangle.

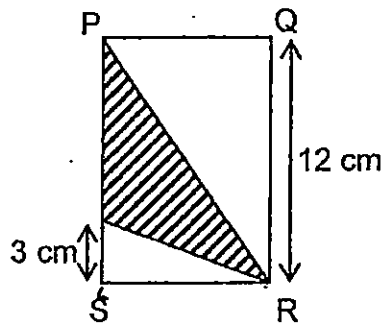

Ans: _____ cm^2

- 25 A tank which has a rectangular base of 10 m by 5 m is half filled with water. If the volume of water is 810 m^3 , what is the height of the tank?

Ans: _____ m

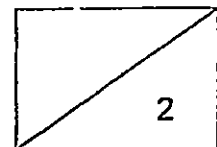

Questions 26 to 30 carry 2 marks each. Show your working clearly in the space provided for each question and write your answers in the spaces provided. For questions which require units, give your answers in the units stated. (10 marks)

26 How many eighths are there in 24?

Ans: _____

27 The prices of admission tickets to Universal Studios Singapore are shown in the table below.

Type	Price
Adult	\$56
Child (aged 12 and below)	\$28

Mr and Mrs Wong took their children, a boy aged 9 and a girl aged 14 to the Universal Studios Singapore. Find the total amount paid for the admission tickets for the whole family.

Ans: \$ _____

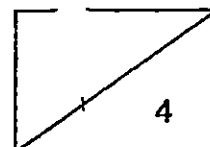

- 28 Cassandra has 54 stamps. Peter has 36 more stamps than Cassandra. What is the ratio of the number of stamps Cassandra has to the number of stamps Peter has? (Express your answer in its simplest form.)

Ans: _____

- 29 In a theatre, there are 25 rows of seats and each row has 8 seats. How many seats are **unoccupied** if only $\frac{3}{5}$ of the theatre is full?

Ans: _____

- 30 A rectangular piece of paper is folded in half. Using the folded edge as a base, three lines, WX, WY and WZ are drawn as shown. The figure formed is then cut out and opened up. What is the area of the cut-out shape?

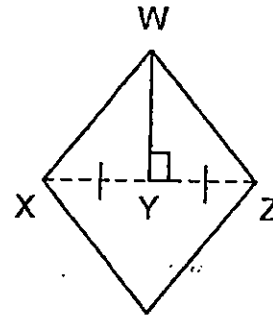
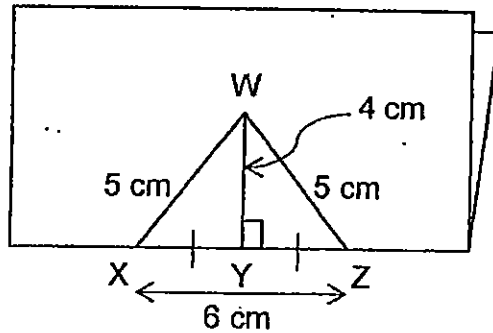

Cut-out figure when it is opened up.

Ans: _____ cm²

END OF PAPER 1

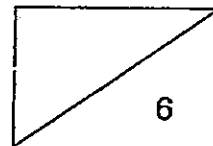



RED SWASTIKA SCHOOL
2015 SEMESTRAL ASSESSMENT 2
MATHEMATICS
PAPER 2

Name : _____ ()

Class : Primary 5 / _____

Date : 30 Oct 2015

18 Questions

60 Marks

Duration of Paper 2: 1 hour 40 minutes

Note:

1. Do not open this Booklet until you are told to do so.
2. Read carefully the instructions given at the beginning of each part of the Booklet.
3. Do not waste time. If a question is difficult for you, go on to the next one.
4. Check your answers thoroughly and make sure you attempt every question.
5. In this paper, you should have the following:
(a) Page 1 to Page 13
(b) Questions 1 to 18
6. You are allowed to use a calculator.

MARKS

	OBTAINED	POSSIBLE
PAPER 1		40
PAPER 2		60
TOTAL		100

Parent's Signature : _____

Questions 1 to 5 carry 2 marks each. Show your working clearly in the space below each question and write your answers in the spaces provided. For questions which require units, give your answers in the units stated. (10 marks)

- 1 The total perimeter of the square and rectangle shown below is 92 cm. Find the area of the square.

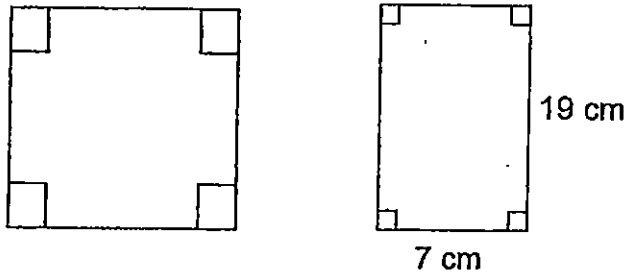

Ans: _____ cm²

- 2 Shade more squares to complete the figure which has the line AB as the line of symmetry.

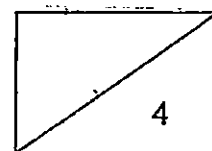
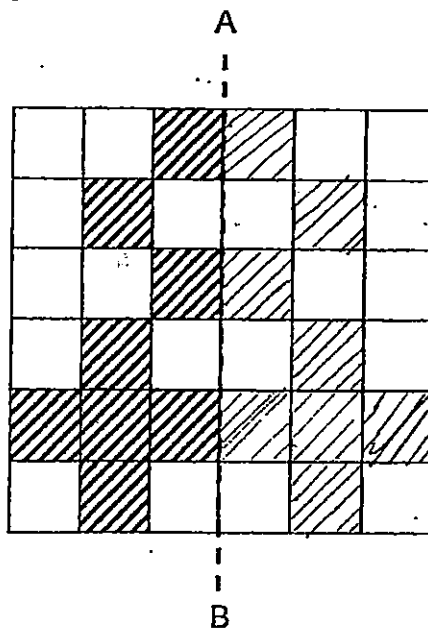

- 3 The bar graph below shows the number of children each family has. Use it to answer Questions 3a and 3b.

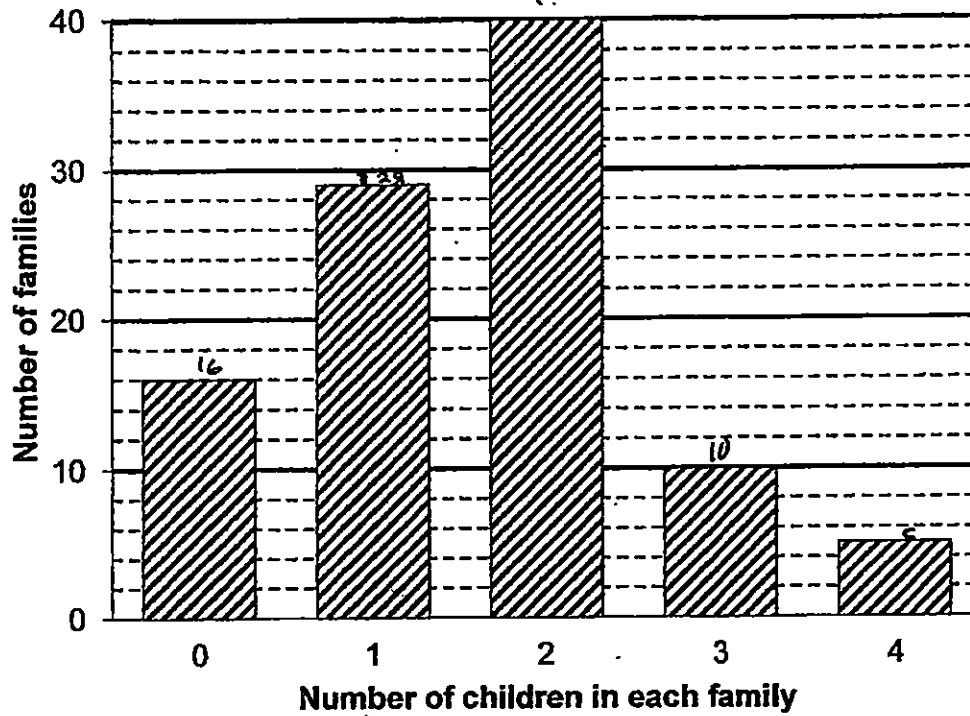

(a) How many families have more than 2 children?

(b) How many children are there in the housing estate?

Ans: (a) _____ [1]

(b) _____ [1]

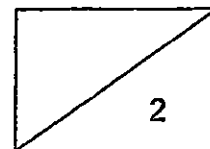

- 4 In a group of 80 students, 56 of them were girls. What percentage of the students were boys?

Ans: _____ %

- 5 There are 24 bottles of milk in a carton. Each bottle of milk has a mass of 0.49 kg. The mass of the empty carton is 0.4 kg. What is the total mass of the carton and the bottles of milk? (Round off your answer to the nearest tenth.)

Ans: _____ kg

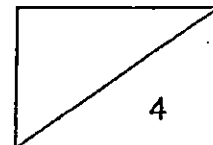

For Questions 6 to 18, show your working clearly in the space below each question and write your answers in the spaces provided. The number of marks available is shown in brackets [] at the end of each question or part-question. (50 marks)

- 6 Mr Lim bought 246 boxes of pencils. Each box contains 9 pencils. He gave away $\frac{2}{9}$ of the pencils and packed the rest of the pencils into packets of 3. How many packets of pencils were there?

Ans: _____ [3]

- 7 When $\frac{2}{5}$ of a metal box was filled with marbles, its mass is 44.4 kg. When it is 0.25 filled with marbles, its mass is 28.2 kg. What is the mass of the empty metal box?

Ans: _____ [3]

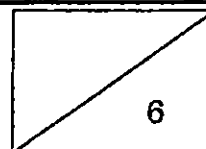

- 8 Mrs Yeo bought 5 dresses. Two of the dresses cost \$108.30 altogether and the other three dresses cost \$52.90 each. Find the average price of the 5 dresses.

Ans: _____ [3]

- 9 In the figure below, not drawn to scale, ABCD is a trapezium and CDE is an isosceles triangle.

(a) Find $\angle CED$.

(b) Find $\angle ADE$.

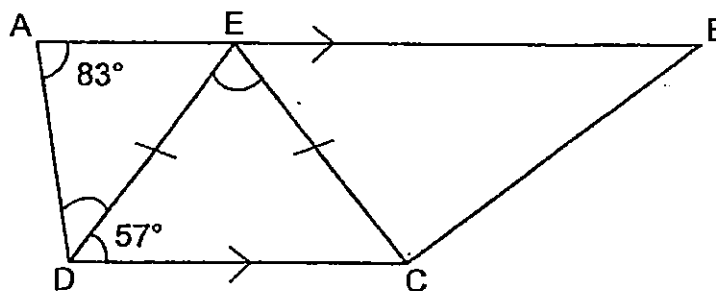

Ans: (a) _____ [1]

(b) _____ [2]

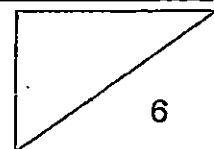

- 10 Jack and Marcus received an equal amount of money. After Jack spent \$70 and Marcus spent thrice as much as Jack, The ratio of Jack's remaining money to Marcus's became 2 : 1. How much money did each boy receive at first?

Ans: _____ [3]

- 11 For every 8 students going for an excursion, there must be one accompanying teacher. 192 students and the required number of teachers are scheduled for an excursion to the zoo. However, on the day of the excursion, 18 students were absent and 5 more teachers followed the group of teachers and students who were present to the zoo. What is the new number of students to each teacher then?

Ans: _____ [3]

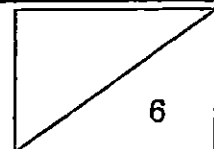

12 A television set cost \$3 600. Mr Lim bought it during a sale at a discount of 25%. On top of that, he has to pay an additional 7% GST on the sale price.

(a) How much GST did he have to pay?

(b) How much did Mr Lim pay altogether?

Ans: (a) _____ [2]

(b) _____ [2]

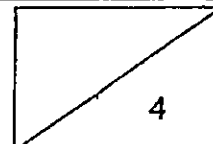

- 13 Hasanah gave $\frac{3}{7}$ of her stickers to her brother and $\frac{3}{5}$ of the remainder to her sister. After giving stickers to her brother and sister, she then gave the rest to her three friends. If each of her friends received 40 stickers, how many stickers did Hasanah have at first?

Ans: _____ [4]

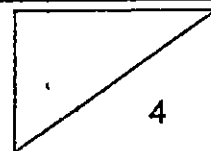

- 14 A sum of money was divided among three sisters, Elsie, Felicia and Heather in the ratio $3 : 2 : 1$ respectively. After Elsie gave \$6 to Felicia and \$3 to Heather, the ratio of the amount of money Elsie had to the amount of money Felicia had to the amount of money Heather had become $2 : 2 : 1$ respectively. What was the sum of money that Felicia and Heather had at the end?

Ans: _____ [4]

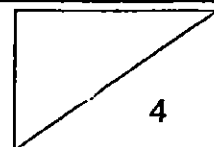

- 15 $\frac{3}{8}$ of the people in a cinema were men. $\frac{2}{5}$ of the remainder were women and the rest were children. Given that there were a total of 120 children, and that there were 30 more boys than girls, what fraction of the people in the cinema were boys? (Express your answer in its simplest form.)

Ans: _____ [5]

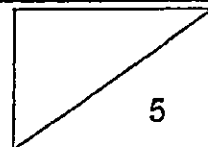

16 A rectangular container measuring 8 m by 0.2 m by 10 m was 60% filled with clay.

- (a) What was the volume of clay?
- (b) When the clay hardened, it was removed from the rectangular container. How many cubes of sides 20 cm could be cut from the hardened clay?

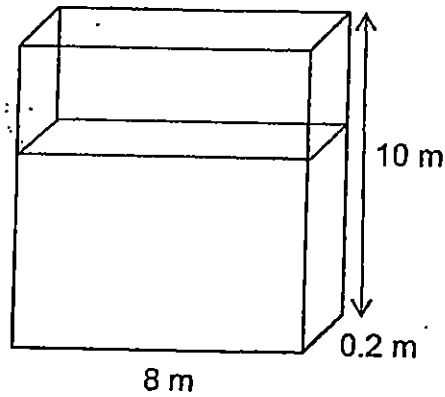

Ans: (a) _____ [2]

(b). _____ [3]

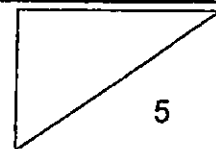

17 Xavier bought 5 t-shirts and 2 pairs of shorts. A t-shirt cost \$21 less than a pair of shorts. He would have spent \$15 less if he had bought 2 t-shirts and 3 pairs of shorts instead.

- (a) Find the cost of a t-shirt.
- (b) How much money did Xavier have?

Ans: (a) _____ [2]

(b) _____ [3]

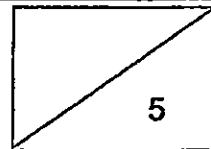

18 Mr Lee bought a dining set for \$1 260 after a discount of 30%.

- (a) What was the price of the dining set before discount?
- (b) Mr Lee then bought a computer table for \$450. The total discount for the dining set and the computer table was \$690. What was the percentage discount given for the computer table?

Ans: (a) _____ [2]

(b) _____ [3]

END OF PAPER 2

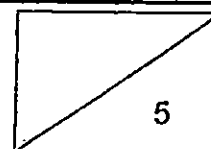



EXAM PAPER 2015
LEVEL : PRIMARY 5
SCHOOL : RED SWASTIKA SCHOOL
SUBJECT : MATHEMATICS
TERM : SA2

Q1	Q2	Q3	Q4	Q5	Q6	Q7	Q8	Q9	Q10
3	4	3	3	4	2	4	2	4	3
Q11	Q12	Q13	Q14	Q15					
3	2	4	3	2					

Q16. $8 \rightarrow 16 \div 2 = 8$

Q17 $16 \rightarrow 24 - 16 \div 4 \times 2 = 24 - 4 \times 2 = 24 - 8 = 16$

Q18. $21.4 \rightarrow 8.43 + 12.95 \approx 21.4$

Q19. $\frac{9}{10} \rightarrow 0.9 = \frac{9}{10}$

Q20. 1hr 50 min

Q21 $1.73\text{m } 15\text{cm} = 0.15\text{m}, 1.58 + 0.15\text{m} = 1.73\text{m}$

Q22. M and H Q23. $343\text{cm}^3 \rightarrow \sqrt[3]{49} = 7, 7 \times 7 \times 7 = 343$

Q24. $27\text{cm}^2 \rightarrow \text{SR} = 12 \div 2 = 6, \frac{1}{2} \times 3 \times 6 = 9, \frac{1}{2} \times 12 \times 6 = 36, 12 \times 6 = 72, 72 - 36 - 9 = 27$

Q25. $32.4\text{m} \rightarrow 810 \times 2 = 1620, 1620 \div 10 \div 5 = 32.4$

Q26. $192 \rightarrow 24 \times 8 = 192$

Q27. $\$196 \rightarrow 56 \times 3 = 168, 168 + 28 = 196$

Q28. $3:5 \rightarrow 54 + 36 = 80, 54:90 = 6:10 = 3:5$

Q29. $80 \rightarrow 25 \times 8 = 200, \frac{2}{5} \times 200 = 80$

Q30. $24\text{cm}^2 \rightarrow \frac{1}{2} \times 4 \times 6 = 12, 12 \times 2 = 24$

Q1. $100\text{cm}^2 \rightarrow 92 - 19 - 19 - 7 = 40, 40 \div 4 = 10, 10 \times 10 = 100$

Q2. SEE PICTURE

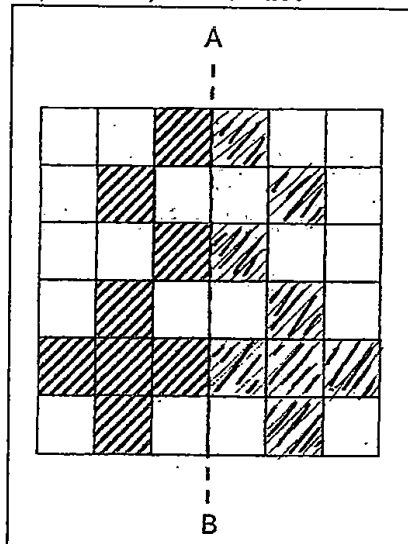

Q3a. $15 \rightarrow 10+5=15$

Q3b. $159 \rightarrow (0 \times 16) + (1 \times 29) + (2 \times 40) + (3 \times 10) + (4 \times 5) = 0+29+80+30+20=159$

Q4. $30\% \rightarrow 80 - 56 = 24, \frac{24}{80} = \frac{3}{10} = 30\%$

Q5. $12.2\text{kg } 24 \times 0.49 = 11.76, 11.76 + 0.4 = 12.16, 12.16 \approx 12.2$

Q6. $574 \rightarrow 246 \times 9 = 2214, 1 - \frac{2}{9} = \frac{7}{9}, \frac{7}{9} \times 2214 = 1722, 1722 \div 3 = 574$

Q7. 1.2kg

$0.25 = \frac{1}{4}$

$\frac{2}{5} - \frac{1}{4} = \frac{3}{20}$

3 marble $\rightarrow 44.4 - 28.2 = 16.2$

1 marble $\rightarrow 16.2 \div 3 = 5.4$

$5.4 \times 20 = 108$

$\frac{2}{5} \times 108 = 43.2$

$44.4 - 43.2 = 1.2$

Q8. $\$53.40 \rightarrow 52.90 \times 3 = 158.70, 108.30 + 158.70 = 267, 267 \div 5 = 53.40$

Q9a. $66^\circ \rightarrow \angle CED = 180 - 57 - 57 - 56 = 66$

Q9b. $40^\circ \rightarrow 180 - 83 = 97, 97 - 57 = 40$

Q10. $\$350 \rightarrow 70 \times 3 = 210, 1u \ 210 - 70 = 140, 140 + 210 = 350$

Q11. $6 \rightarrow 192 \div 8 = 24, 192 - 18 = 174, 24 \div 5 = 29, 174 \div 29 = 6$

Q12a. $\$189 \rightarrow 100 - 25 = 75, \frac{75}{100} \times 3600 = 2700, 2700 \div 100 = 27, 27 \times 7 = 189$

Q12b. $\$2889 \rightarrow 2700 + 189 = 2889$

Q13. $525 \rightarrow 40 \times 3 = 120, 1 - \frac{3}{7} = \frac{4}{7}, 1 - \frac{3}{5} = \frac{2}{5}, \frac{2}{5} \times \frac{4}{7} = \frac{8}{35}, 120 \div 8 = 15, 15 \times 35 = 525$

Q14. $\$54$

Total unchanged

Before \rightarrow E: F: Total, $3 : 2 : 1 : 6 = 15 : 10 : 5 : 30$

After \rightarrow E:F:H:Total, $2 : 2 : 1 : 5, 12 : 12 : 6 : 30$

$2u \rightarrow \$6, 1u \rightarrow \$6 \div 2 = \$3, 12 + 6 = 18, 18u \rightarrow \$3 \times 18 = \$54$

$$\text{Q15. } \frac{15}{64}$$

$$1 - \frac{2}{8} = \frac{5}{8}$$

$$\frac{2}{5} \times \frac{5}{8} = \frac{1}{4}$$

$$\text{Children} \rightarrow 1 - \frac{3}{8} - \frac{1}{4} = \frac{3}{8}$$

$$120 - 30 = 90, 90 \div 2 = 45$$

$$\text{Boys} \rightarrow 45 + 30 = 75, 120 \div 3 = 40, 40 \times 8 = 320, \frac{75}{320} = \frac{15}{64}$$

$$\text{Q16a. } 9.6\text{m}^3 \rightarrow \frac{60}{100} \times 8 \times 0.2 \times 10 = 9.6\text{m}^3$$

$$\text{Q16b. } 1200$$

$$\frac{60}{100} \times 10 = 6, 8\text{m} = 800\text{cm}, 0.2\text{m} = 20\text{cm}, 6\text{m} = 600\text{cm}, 800 \div 2 = 40, 20 \div 2 = 1,$$

$$600 \div 20 = 30, 40 \times 1 \times 30 = 1200$$

$$\text{Q17a } \$18$$

$$\text{Q17b. } \$168 \rightarrow 54 \div 3 = 18, 18 \times 5 = 90, 90 + 78 = 168$$

$$\text{Q18a. } \$1800 \rightarrow 100 - 30 = 70, 1260 \div 70 = 18, 18 \times 100 = 1800$$

$$\text{Q18b. } 25\% \rightarrow 18 \times 30 = 540, \$690 - 540 = 150, 450 + 150 = 600, \frac{150}{600} = \frac{1}{4} = 25\%$$

THE END

100 100 100