

# METHODIST GIRLS' SCHOOL

Founded in 1887



## MID-YEAR EXAMINATION 2014 PRIMARY 4 SCIENCE

### BOOKLET A

Total Time for Booklets A and B: 1 hour 45 minutes

#### INSTRUCTIONS TO CANDIDATES

Do not turn over this page until you are told to do so.

Follow all instructions carefully.

Answer all questions.

Shade your answers in the Optical Answer Sheet (OAS) provided.

Name: \_\_\_\_\_ (    )

Class: Primary 4 \_\_\_\_\_

Date: 12 May 2014

This booklet consists of 20 printed pages including this page.

For each question from 1 to 25, four options are given. One of them is the correct answer. Make your choice (1, 2, 3 or 4). Shade the correct oval (1, 2, 3 or 4) on the optical answer sheet. [50 marks]

- 1 Jenny uses the chart to classify the physical characteristics of four animals.

Animal	Has hair	Has 6 legs	Lays eggs	Gives birth to its young alive
A	√		√	
B	√			√
C		√	√	
D				√

Which one of the animals A, B, C or D is most likely an insect?

- (1) A  
 (2) B  
 (3) C  
 (4) D
- 2 Look at the pictures below. Which one of the following is not a fruit?

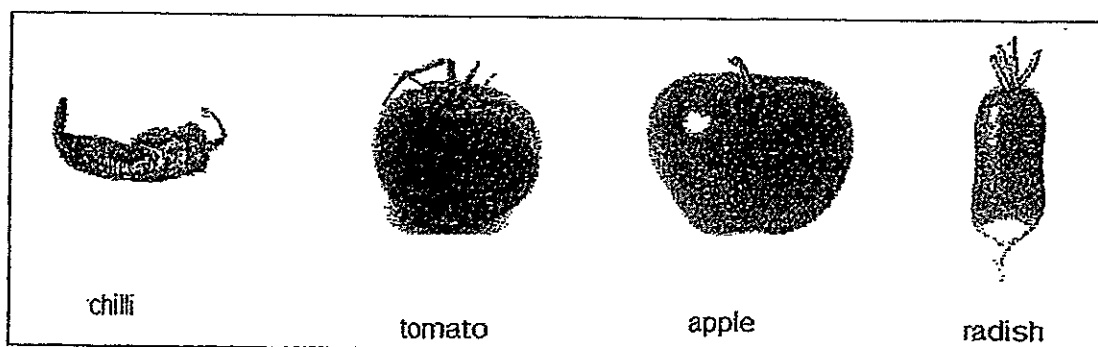

- (1) chilli  
 (2) tomato  
 (3) apple  
 (4) radish

- 3 Ahmad uses the chart below to help him classify things.

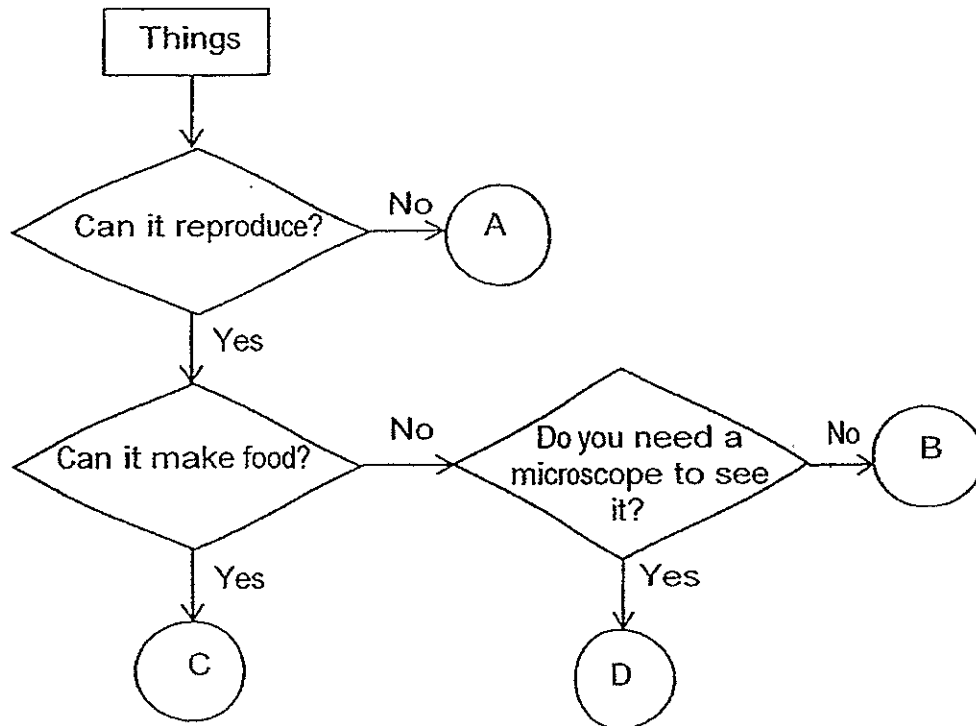

Using the flow chart, where should Ahmad place the ruler and the sparrow.

	Ruler	Sparrow
(1)	A	B
(2)	A	D
(3)	C	D
(4)	C	B

- 4 Study the life cycle of Animal X and Animal Y below.

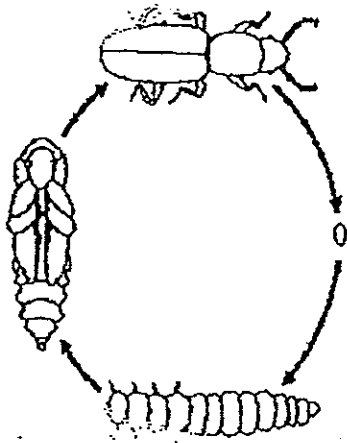

Animal X

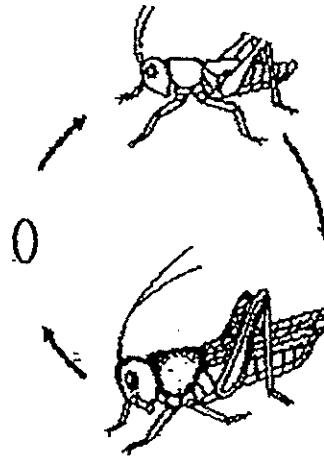

Animal Y

Which one of the following statements is true about the life cycle shown above?

- (1) Animal X gives birth to its young alive but Animal Y does not.
- (2) Animal X has an egg stage in its life cycle but Animal Y does not.
- (3) Animal X has a larval stage in its life cycle but Animal Y does not.
- (4) Animal X has a young that looks like the adult while Animal Y does not.

5 Study the flow chart below.

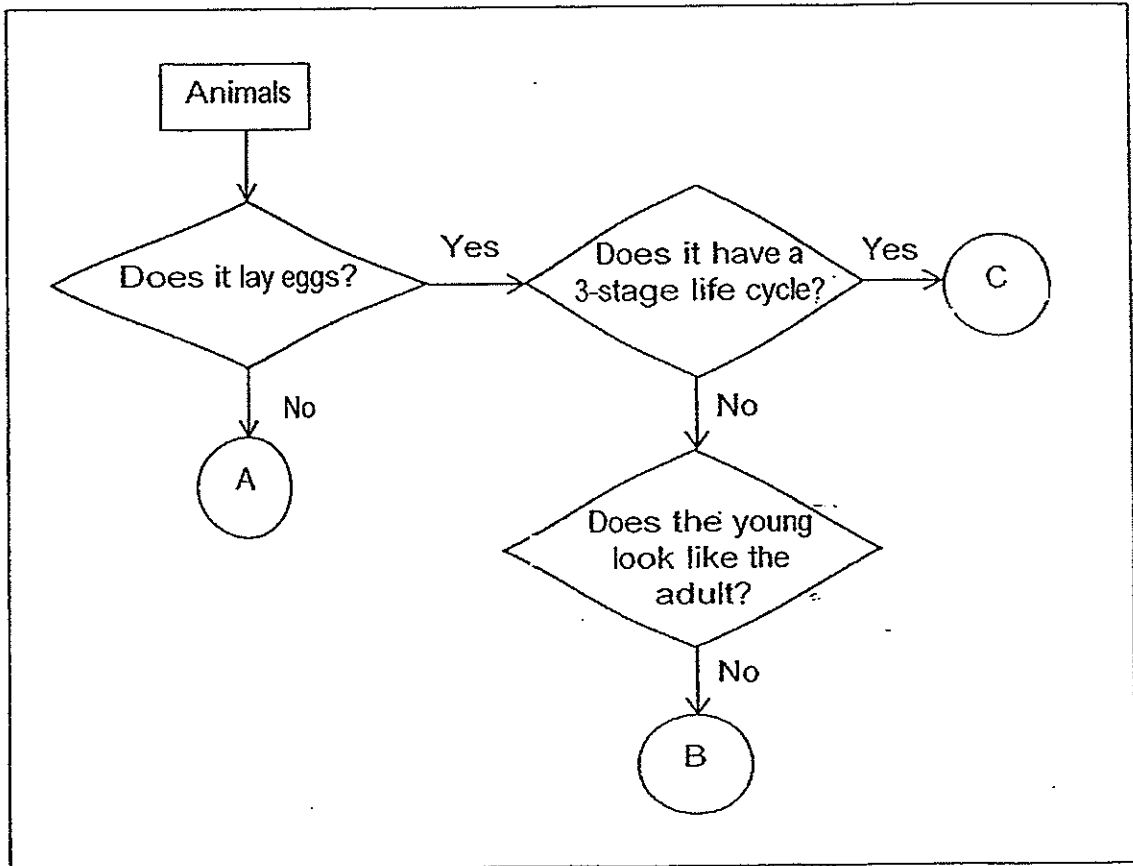

Based on the information given in the flowchart, which one of the following correctly represents animals A, B and C?

	A	B	C
(1)	tiger	moth	cockroach
(2)	tiger	cockroach	moth
(3)	duck	cockroach	moth
(4)	duck	moth	cockroach

6. Jill placed a seed into a container of soil as shown below. She watered the soil daily.

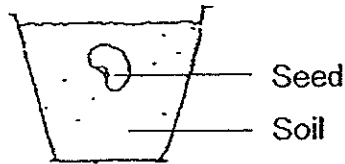

Which one of the following diagrams shows what Jill would observe after some time?

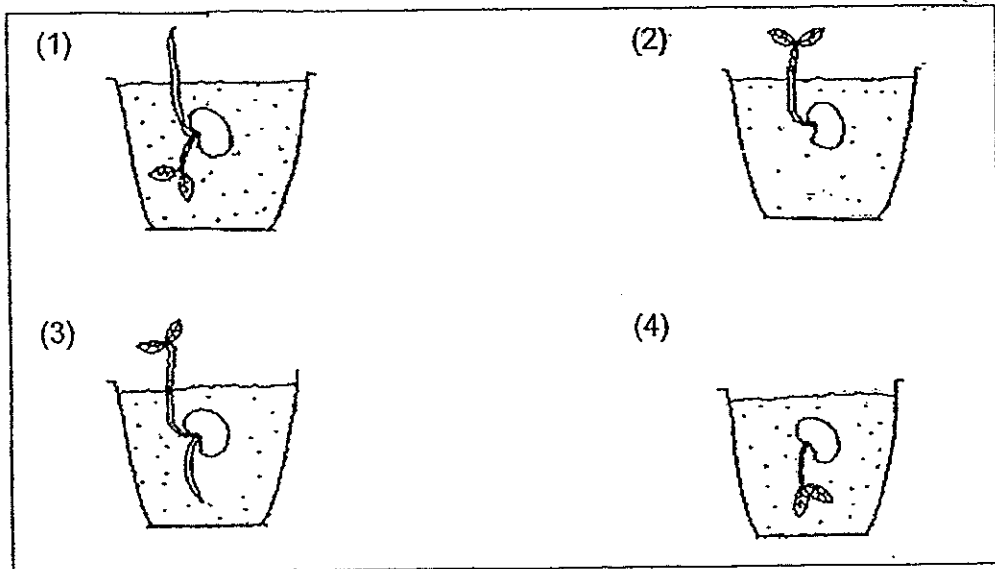

7. Study the graph below carefully.

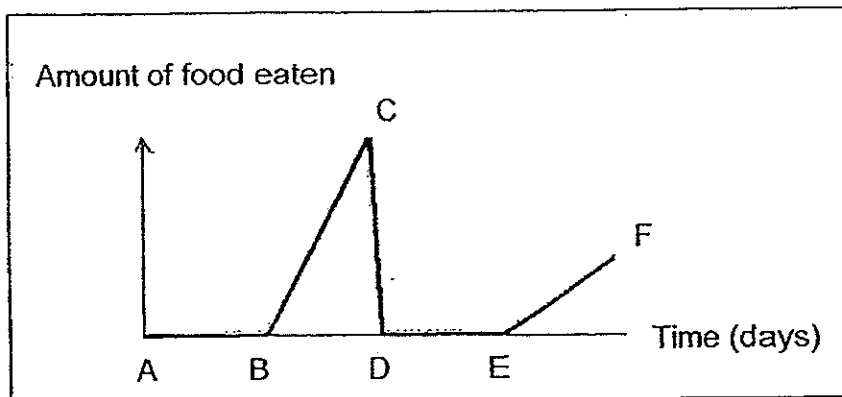

The line "BC" shows the \_\_\_\_\_ stage of a mosquito.

- (1) egg
- (2) larval
- (3) pupal
- (4) adult

8. The diagram below shows the life cycle of an animal. Which one of the following does not have the same kind of life cycle as shown below.

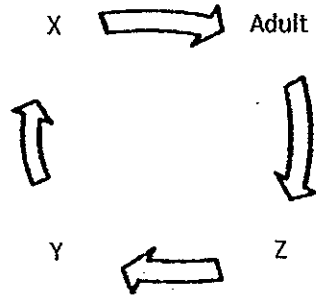

- (1) mosquito  
 (2) moth  
 (3) grasshopper  
 (4) mealworm beetle
9. Which one of the following graphs correctly shows the relationship between the mass of the seed leaves and the height of the seedlings?

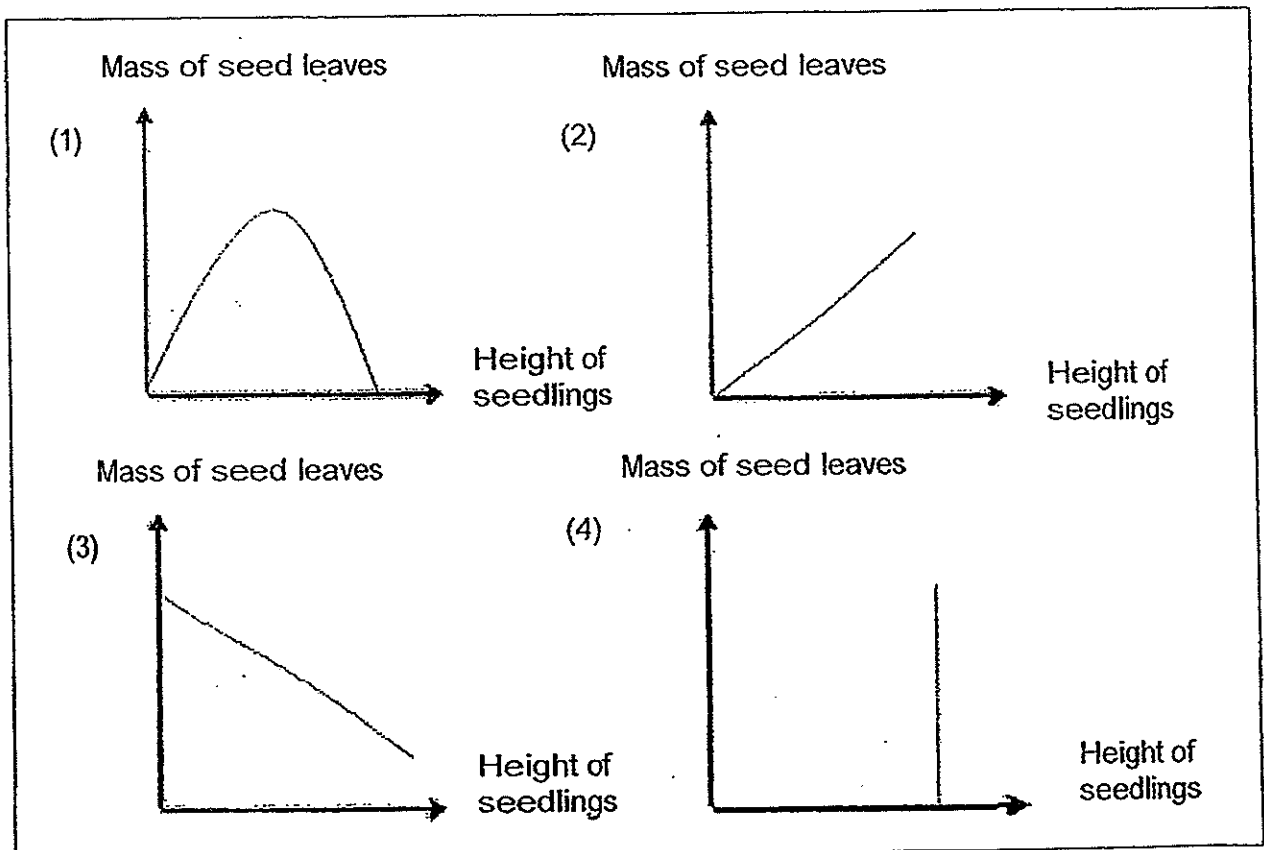

10. Study the life cycles of the mosquito and the dragonfly as shown below.  
Which of the following are correct?

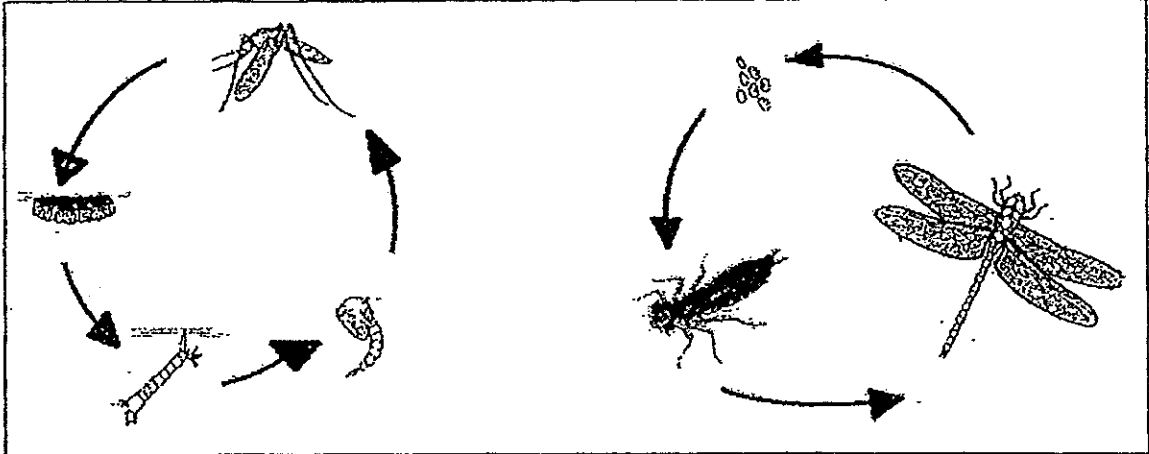

- A: The young of the dragonfly and the young of the mosquito live in water.  
 B: The life cycle of the mosquito has an egg stage but the dragonfly does not.  
 C: The dragonfly has a three-stage life cycle whereas the mosquito has a four-stage life cycle.  
 D: The young of the dragonfly resembles the adult but the young of the mosquito does not.



- (1) A and B only  
 (2) C and D only  
 (3) A and C only  
 (4) B and D only



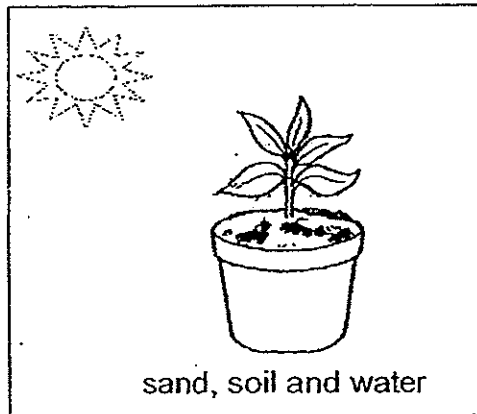



11. An experiment was conducted to find out if adding sand to soil helps a plant to grow better. Two set-ups were required. One of the set-ups is shown below.



To ensure a fair test, which one of the following should be the other set-up?

(1)    
sand and water

(2)    
soil and water

(3)    
sand

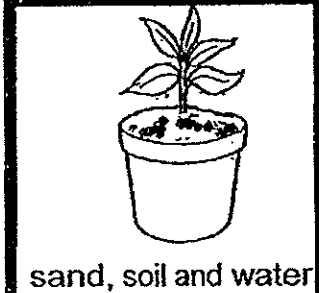
(4)    
sand, soil and water

inside a cupboard

12. Joe wanted to find out the conditions needed for seeds to germinate. He put four seeds in similar dishes and placed the same amount of cotton wool in the dishes. He then placed the dishes at different locations subjected to different conditions.

Set-up A

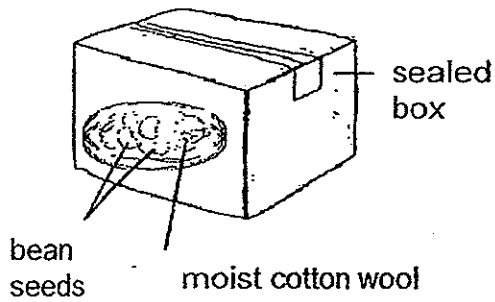

Set-up B

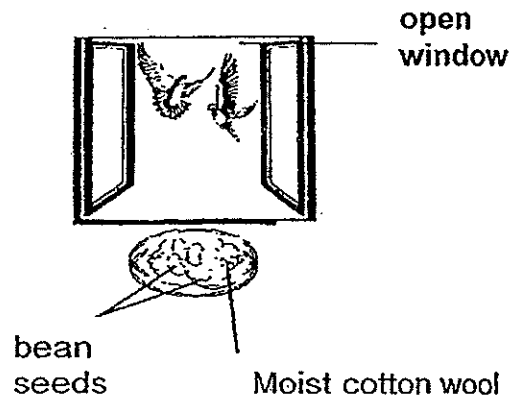

Set-up C

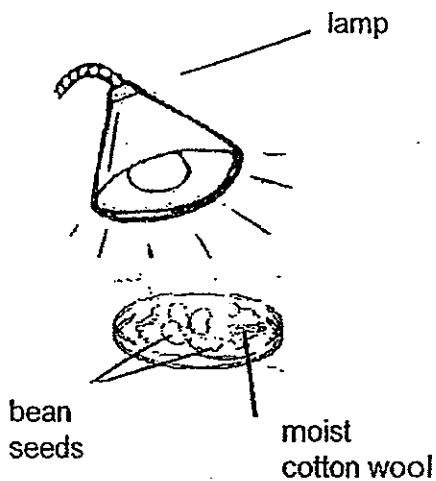

Set-up D

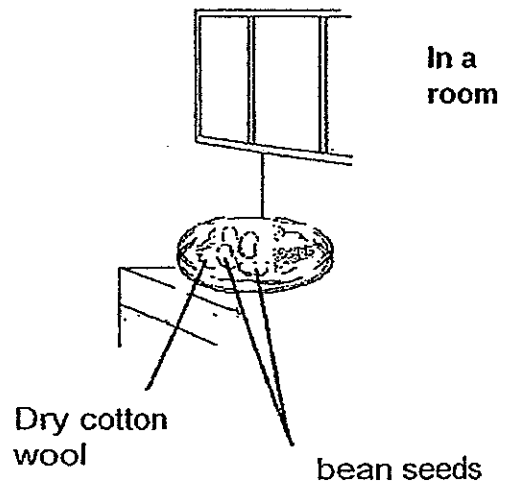

In which of the set-ups would seeds germinate?

- (1) A and B only
- (2) A and C only
- (3) A, B and C only
- (4) B, C and D only

- 13 Tina conducted an experiment to study the hardness of three different materials A, B and C. She used the sharp ends of a plastic rod and a wooden rod to scratch each of these materials. She recorded her observations in the table below.

Rod used to scratch material	Scratch marks observed on material		
	A	B	C
plastic	No	Yes	Yes
wood	No	No	Yes

Which one of the following statements is correct?

- (1) A and B are harder than plastic.
  - (2) B and C are harder than plastic.
  - (3) A and B are harder than wood.
  - (4) B and C are harder than wood.
- 14 Lisa had two identical syringes. Each syringe was covered with black paper and completely filled with air or water.

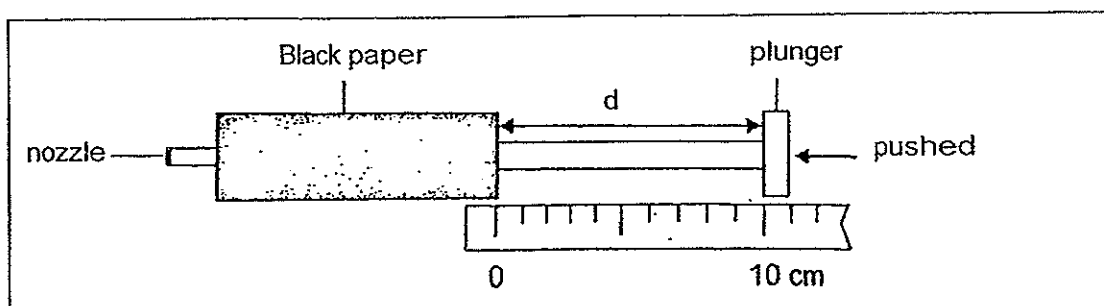

She covered each nozzle tightly with her finger and pushed the plunger in as hard as she could. She then measured the distance  $d$ . Which one of the following shows the correct values of  $d$ ?

	$d$ (cm)	
	Syringe with air	Syringe with water
(1)	0	10
(2)	10	0
(3)	5	10
(4)	10	5

15 Study the flow chart about the characteristics of objects given below.

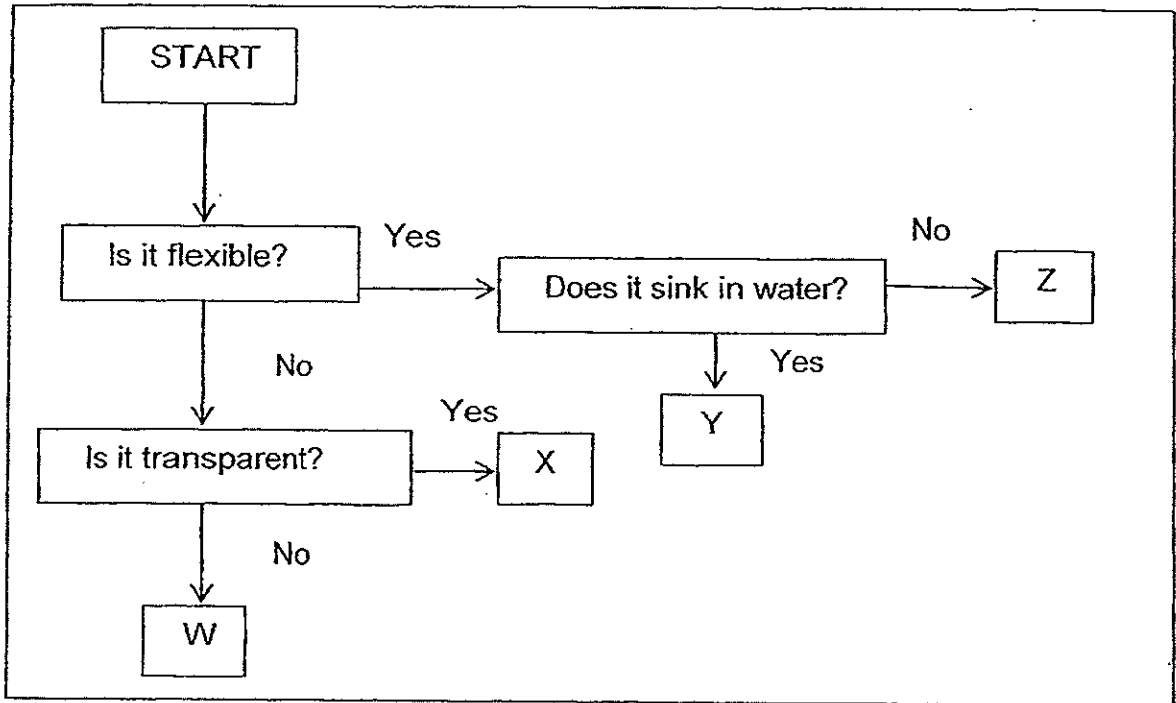

What characteristics does Object X have?

- A: It is transparent.
- B: It is flexible.
- C: It is not flexible.
- D: It sinks in water

- (1) A only
- (2) A and B only
- (3) A and C only
- (4) A, C and D only

- 16 Diagram 1 shows a ring magnet being lowered onto a tray of iron nails. Diagram 2 shows the bottom view of the magnet.

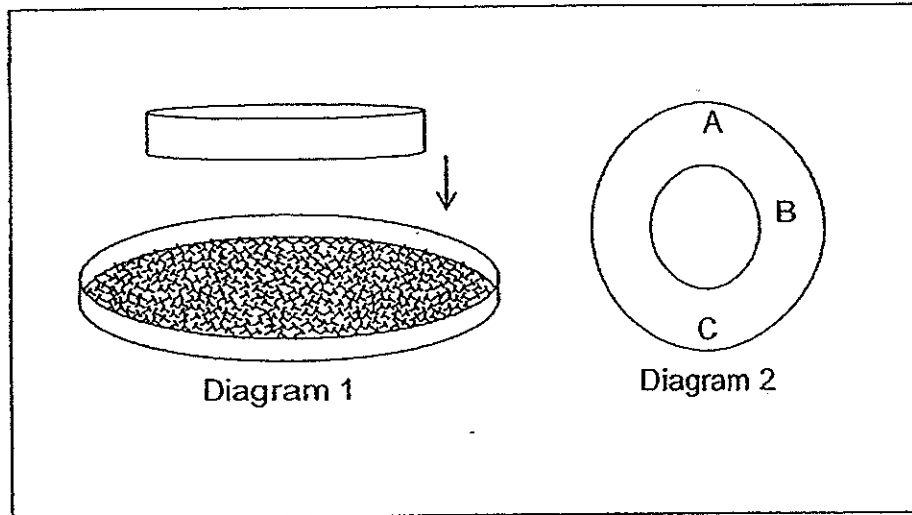

Which one of the following most likely shows the number of nails attracted to the bottom of the magnet at A, B and C after it was taken out from the tray of iron nails?

	A	B	C
(1)	4	10	8
(2)	10	6	10
(3)	8	6	4
(4)	8	8	8

- 17 Shu En designed a toy see-saw using magnets. The toy would move continuously when she tilted one end of the aluminium rod to bring the magnets nearer.

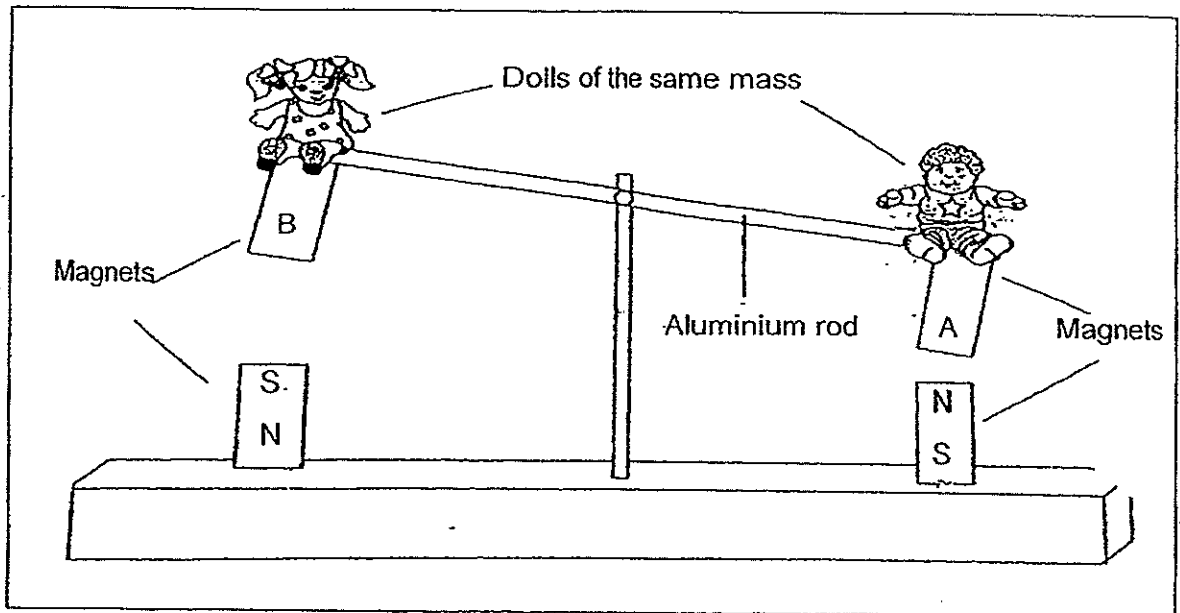

Which of the following statements are true of her design?

- A: A is the north pole of the magnet.  
 B: B is the south pole of the magnet,  
 C: The continuous movement is caused by attraction of unlike poles.  
 D: The continuous movement is caused by repulsion of like poles.
- (1) A and B only  
 (2) A and D only  
 (3) A, B and C only  
 (4) A, B and D only

- 18 Four identical containers holding different types of matter are shown below.

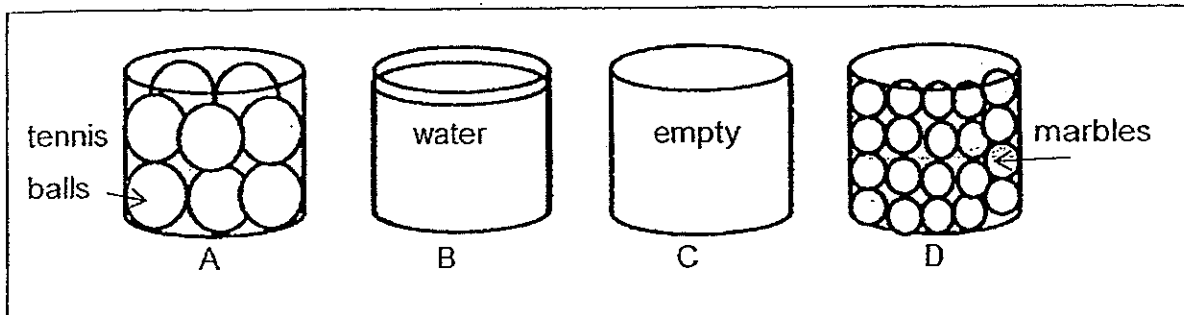

A jar of water is poured into each container at the same time and at the same speed.

Arrange the containers in order, starting with the one that will overflow first.

	Overflow first	→			Overflow last
(1)	B	A	D	C	
(2)	B	D	A	C	
(3)	B	C	A	D	
(4)	B	D	C	A	

- 19 Siti placed an ice cube into a mug of hot chocolate as shown below.  
What happened after five minutes?

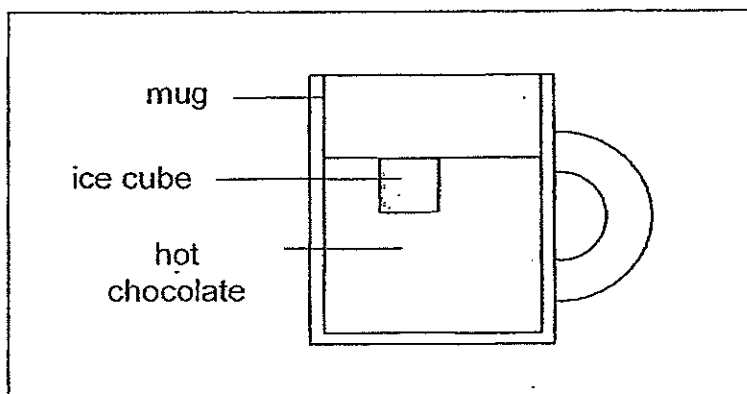

- (1) The ice cube lost heat to the mug.
- (2) The mug lost heat to the hot chocolate.
- (3) The ice cube gained heat from the hot chocolate.
- (4) The hot chocolate gained heat from the ice cube.

20 Study the flow chart about A, B, C and D as shown.

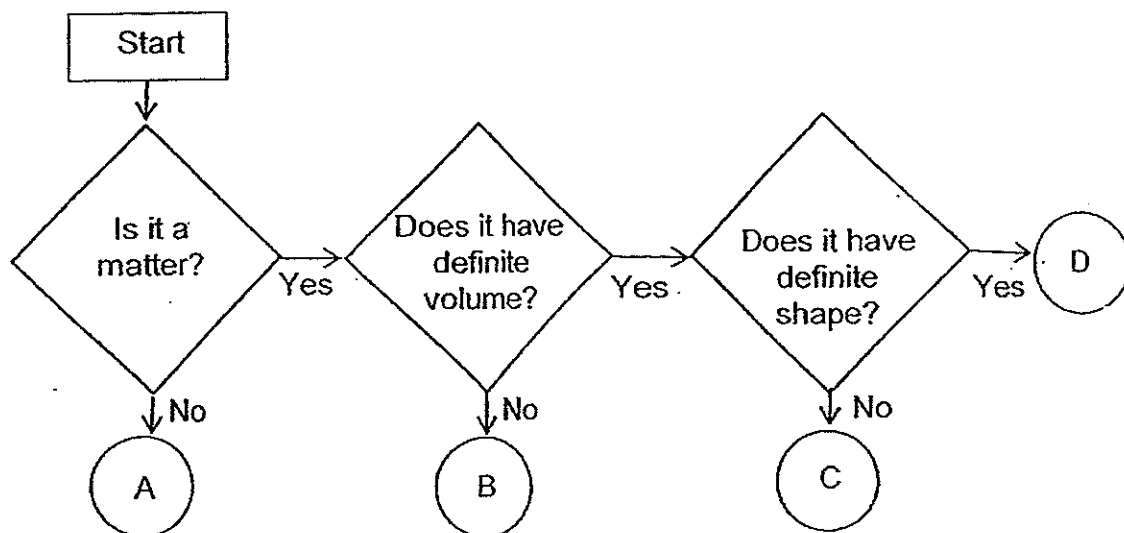

Which one of the following correctly shows what A, B, C and D are?

	A	B	C	D
(1)	oxygen	light	stone	honey
(2)	shadow	air	honey	stone
(3)	heat	milk	air	book
(4)	air	oil	shadow	bottle

21 Edmund and her black dog were in a dimly lit room. Which one of the following statements correctly explains why he could only see the dog's eyes clearly.

- (1) Edmund's eyes were sources of light.
- (2) The dog's eyes were sources of light.
- (3) Light was reflected from Edmund's eyes to the dog's eyes.
- (4) Light was reflected from the dog's eyes to Edmund's eyes.



- 22 Tim set up the following experiment to measure the amount of light passing through three materials, A, B and C using a light sensor fixed at one end of a wooden tube. A light source was attached at the other end of the tube.

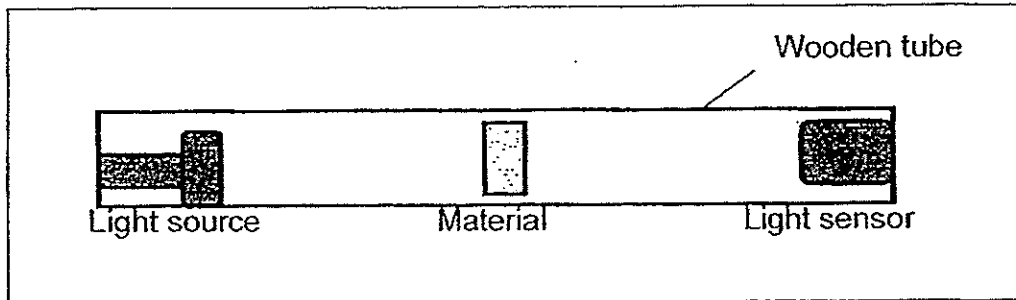

He recorded the results in the table below.

Material	Amount of light (units) measured by light sensor
A	155
B	273
C	90

Which one of the following shows correctly the arrangement of materials according to the amount of light passing through it?

	Allows least light to pass through		Allows most light to pass through
(1)	B	A	C
(2)	B	C	A
(3)	C	A	B
(4)	C	B	A



23 Tracy had the following items.

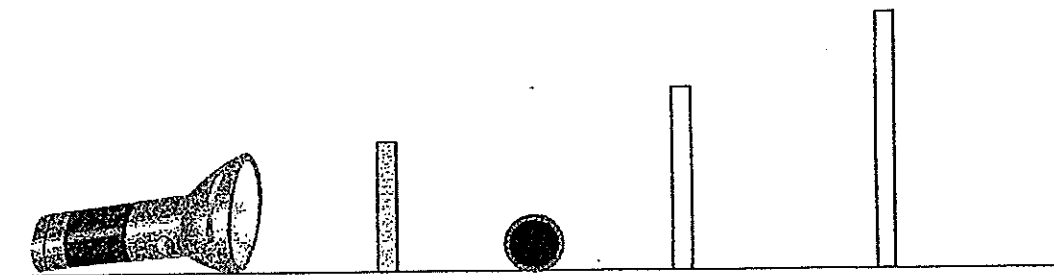
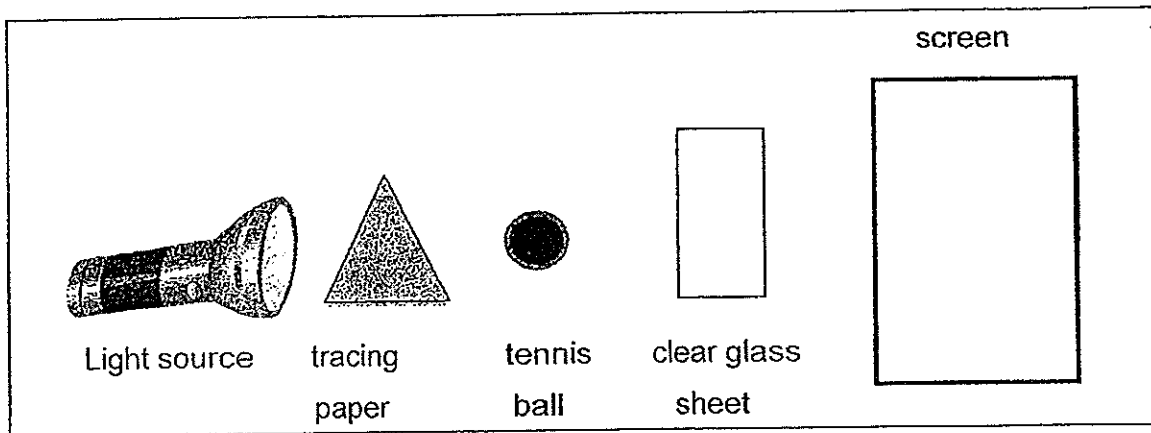

After arranging the items as shown above, what shadow could she see on the screen when the torch was switched on?

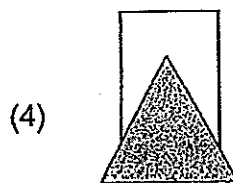
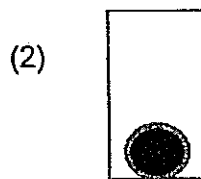
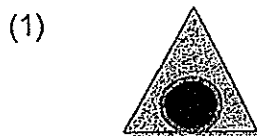

- 24 Su Ching had some ice cubes, a beaker and a Bunsen burner. The table below showed what happened to the ice cubes every 10 minutes.

First 10 minutes	Ice cubes were heated in a beaker until all the ice melted.
Next 10 minutes	The water was heated continuously to boiling point.
Next 10 minutes	The water was left boiling.
Last 10 minutes	The burner was turned off. The water was left in the beaker.

Which graph correctly shows what happened to the ice cube?

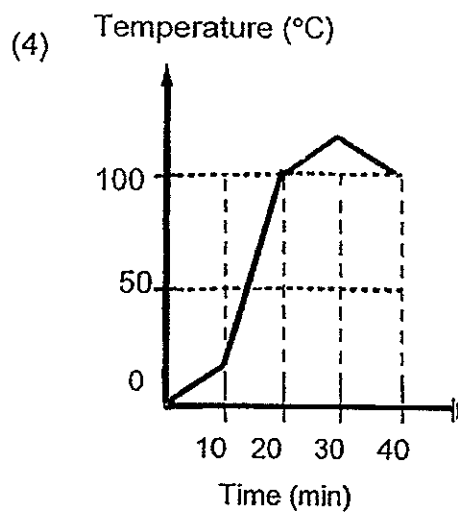
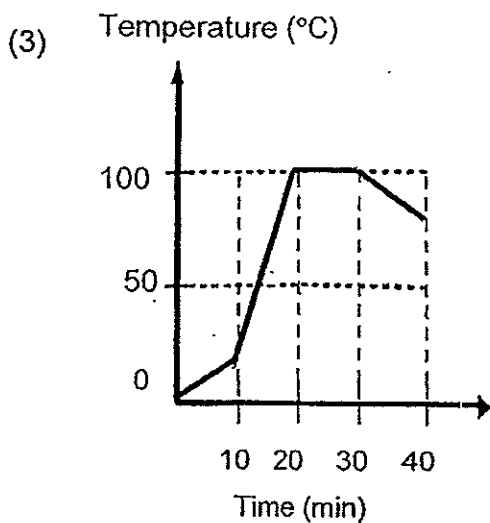
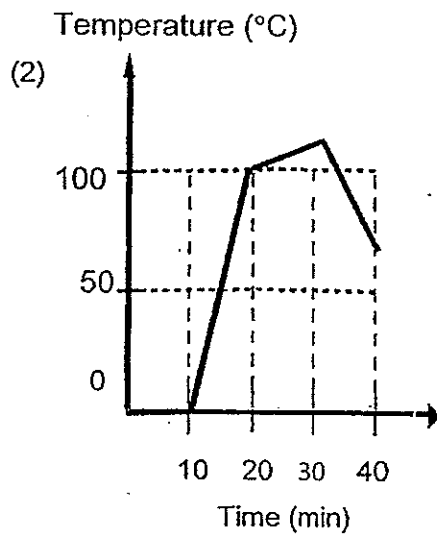
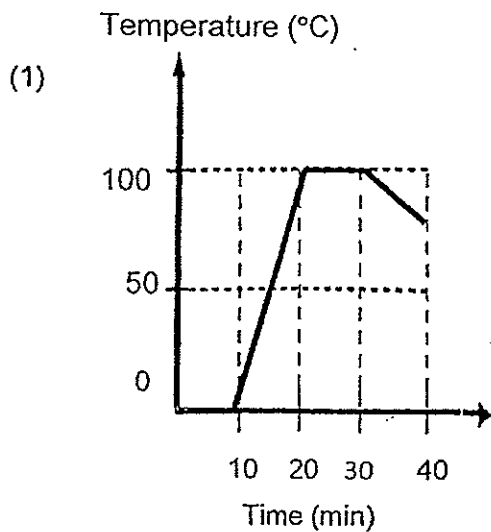

- 25 Mr Tan had four rods of the same thickness and length. They were made of different materials, W, X, Y and Z. He wanted to use the set-ups shown below to find out how well the materials could conduct heat.

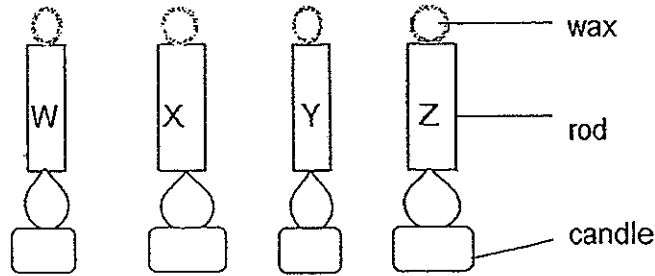

The time taken for the drop of wax on top of each rod to melt completely was recorded in the table shown below.

Rod	Time taken for the drop of wax to melt (seconds)
W	45
X	40
Y	50
Z	60

Based on Mr Tan's experiment, which of the following statement/s is/are correct?

- A: Rod Y conducted heat faster than rod W.  
 B: Rod Z needed most time to conduct heat.  
 C: Rod X is the best conductor of heat.
- (1) B only  
 (2) C only  
 (3) B and C only  
 (4) A, B and C only

END OF BOOKLET A



# METHODIST GIRLS' SCHOOL

Founded in 1887



## MID-YEAR EXAMINATION 2014 PRIMARY 4 SCIENCE

### BOOKLET B

Total Time for Booklets A and B: 1 hour 45 minutes

#### INSTRUCTIONS TO CANDIDATES

Do not turn over this page until you are told to do so.

Follow all instructions carefully.

Answer all questions.

Write your answers in this booklet.

Name: \_\_\_\_\_ (    )

Class: Primary 4. \_\_\_\_\_

Date: 12 May 2014

<b>Booklet A</b>	<b>/ 50</b>
<b>Booklet B</b>	<b>/ 40</b>
<b>TOTAL</b>	<b>/ 90</b>

This booklet consists of 14 printed pages including this page.





For questions 26 to 38, write your answers in the space provided.

[40m]

- 26 In the following statements write "T" for statements that are true and "F" for statements that are false [2m]

		T or F
(a)	A penguin flies and swims about.	
(b)	Yeast needs food, air and water to live.	
(c)	A shark breathes through gills and swims.	
(d)	Some fungi have chlorophyll and are able to make food.	

- 27 Ali placed a grasshopper, a potted plant and a dish of water in a glass-bottle. He sealed the bottle tightly with a rubber cap and then placed it in a dark cupboard.

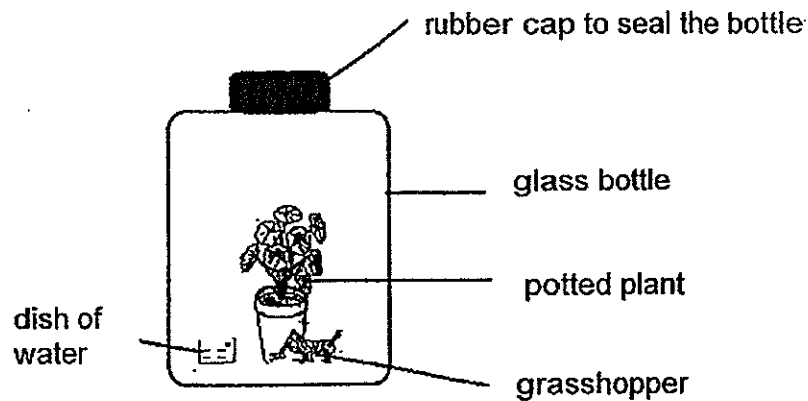

- (a) What would happen to the grasshopper after two weeks? [1m]
- 
- (b) Explain your answer in (a). [1m]
- 
- (c) What can be done to prevent what you described in (a) from happening? [1m]
- 

(Go on to the next page)

28 Study the table below and answer the questions that follow.

Characteristic of plant	Plant A	Plant B	Plant C
Has edible fruit	√	x	√
Has poisonous parts	x	√	√
Has woody stem	√	√	√

Mano made the following comment:

"Plant C is wrongly classified. How can a plant be poisonous and edible at the same time?"

- (a) Do you think Mano's statement is correct or wrong? Give a reason for your answer. [1m]

---

- (b) State two differences between Plant A and Plant B. [1m]

---

- (c) Put ticks(√) in the appropriate boxes to show the characteristics of the hibiscus plant, balsam plant and the durian tree in the table below. [2m]

Characteristics of plant	Hibiscus plant	Balsam plant	Durian tree
Has edible fruit			
Has flowers			

(Go on to the next page)

- 29 Ah Beng plants a young chilli plant in a pot containing an adult balsam plant. He waters them every day.

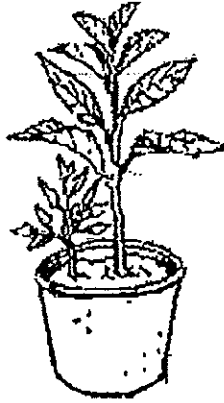

The table below shows the growth of the chilli plant for six weeks.

Week	1	2	3	4	5	6
Height of chilli plant (cm)	1	2	3	4	4	4

- (a) Based on the table above what can you say about the growth of the chilli plant from Week 1 to Week 6? [1m]

---

---

- (b) Based on the above experiment, give a reason for your observation in (a). [1m]

---

---

(Go on to the next page)

30 Study the classification chart below.

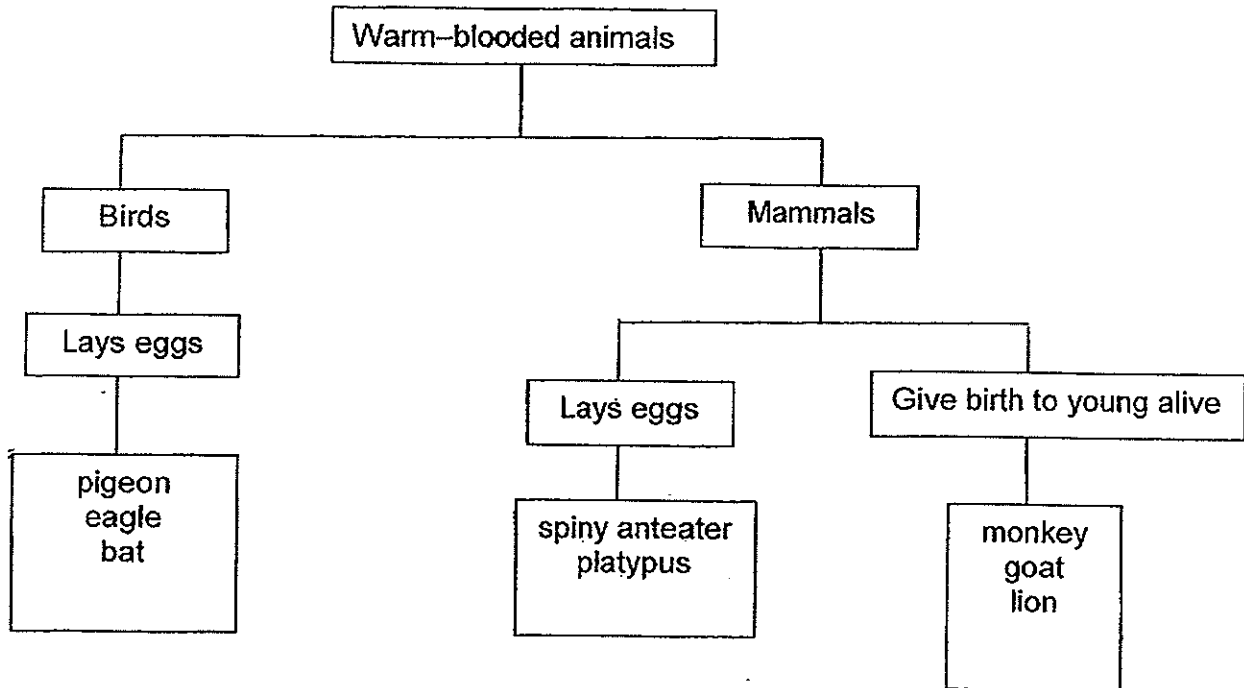

Give your answers based on the classification chart above.

- (a) List the characteristics of the spiny anteater. [1m]

---



---

- (b) One organism is wrongly classified. Which organism is wrongly classified? [1m]

---

- (c) Mark an "X" in the classification table to show where the organism in (b) should be classified.

[1m]

(Go on to the next page)

31 Living things can be classified using the classification chart shown below.

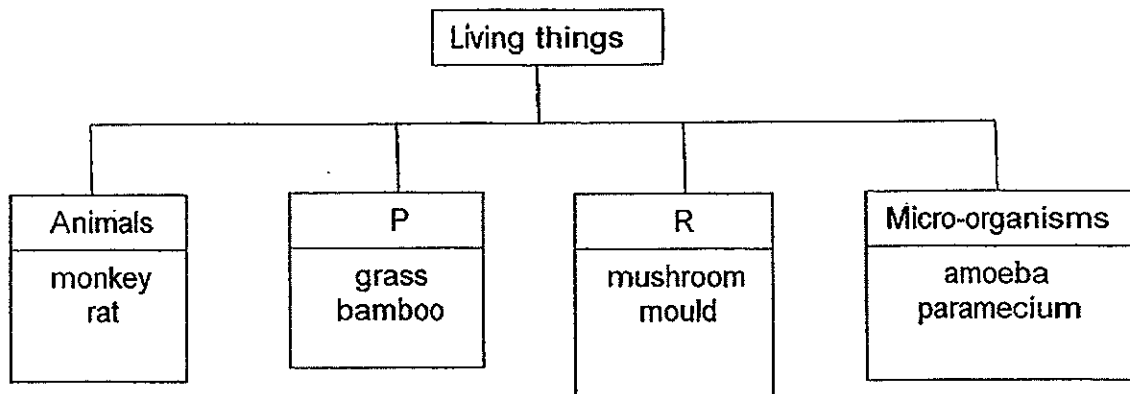

(a) Give a suitable heading for [1m]

(i) P : \_\_\_\_\_

(ii) R: \_\_\_\_\_

(b) How is the method of obtaining food by the organisms in Group R different from the method used by those in Group P? [1m]

---



---

(Go on to the next page)

32 Study the table below.

Plant	Type of plant	Seed	Leaf	Where the plant can be found
A	non-flowering plant		entire edge	land
B	flowering plant	a few	entire edge	land
C	flowering plant	many	lobed edge	water
D	flowering plant	many	lobed edge	land
E	flowering plant	a few	toothed edge	water

Using the information given in the table above, classify the five plants by placing the letters B to E in the boxes in the classification diagram below. A is done for you. [2m]

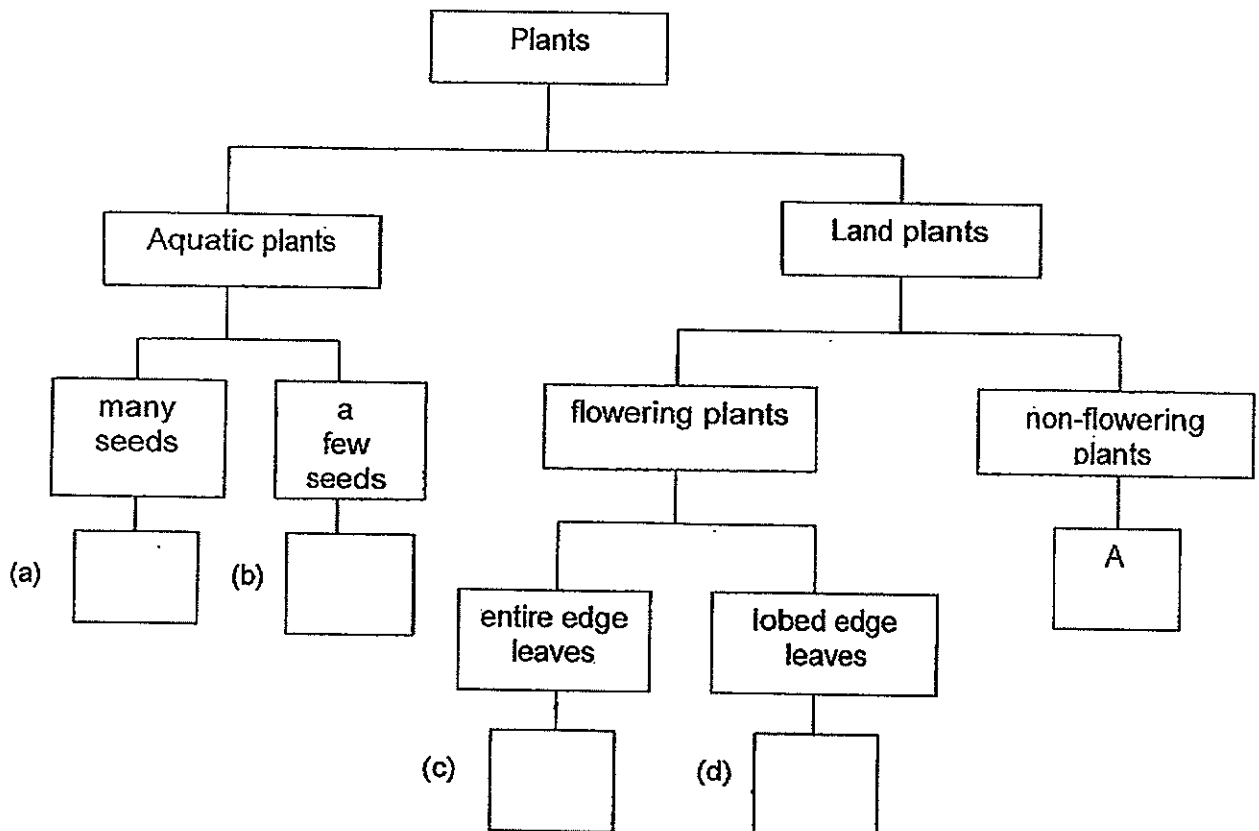

(Go on to the next page)

- 33 The statements A to H describe the events that lead to the maturation of a plant. They are not in the correct order. [2m]

A	The root grows first.
B	The seedling obtains the food it needs from the seed leaves.
C	A seed needs air, water and warmth before it can germinate.
D	The part that comes out next is the shoot.
E	It grows downwards because of gravity.
F	The seedling develops its leaves and starts making food.
G	More leaves will develop as the plant grows.
H	The seed leaves will wither, die and fall off when it is no longer needed.

Complete the diagram below to show the correct order.

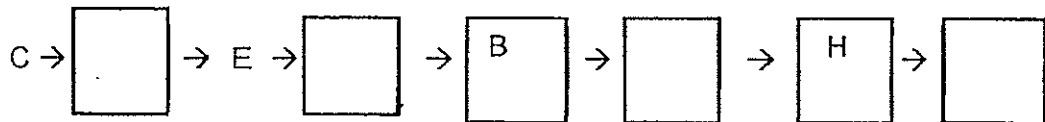

(Go on to the next page)

- 34 A steel bar AB was magnetized using the 'stroke' method as shown in the diagram below.

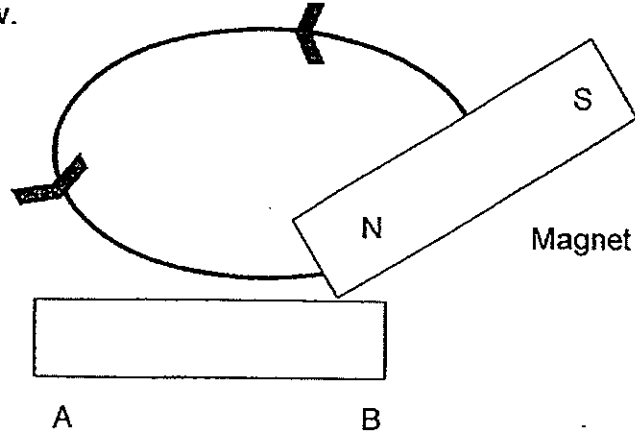

- (a) State what the magnetic poles of the steel bar AB would be at A and B. [1m]
- (i) At A: \_\_\_\_\_ pole
- (ii) At B: \_\_\_\_\_ pole
- (b) Susan wants to magnetise an aluminium bar CD using the North pole of a magnet. However, no matter how many times she strokes the bar, it is not able to pick up any steel paper clips.

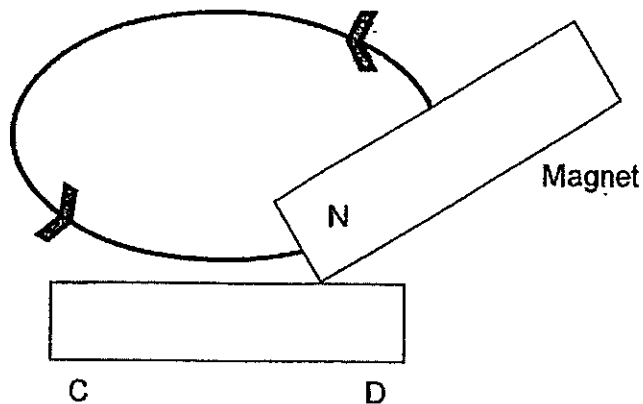

- (i) Give a reason why that happened. [1m]
- 
- (ii) Before Susan magnetizes another bar, what material should she ensure the bar is made of? Name one material. [1m]
- 

(Go on to the next page)



- 35 (a) The diagram below shows a transparent container filled with water. There is an air-tight stopper at the opening at A. The water levels at A and D are given.

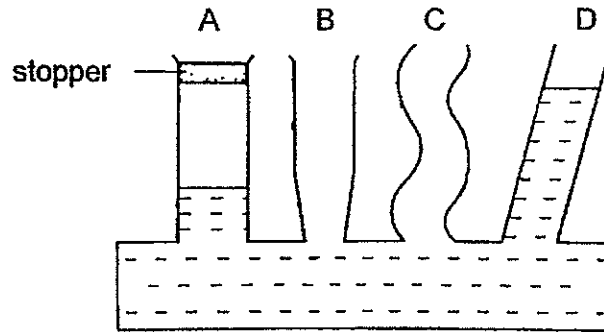

- (i) Use a ruler and pencil to draw in the water level at B and C. [1m]
- (ii) Explain why the water levels at A and D are different. [1m]
- \_\_\_\_\_
- \_\_\_\_\_
- (iii) What could be done to make the water levels at A, B, C and D the same? [1m]
- \_\_\_\_\_
- (b) Name 2 properties of water that can be seen from the diagram. [2m]

- (i) \_\_\_\_\_
- (ii) \_\_\_\_\_

(Go on to the next page)

- 36 Dawn conducted an experiment using a torch, an object and a screen. The height of the shadow of the object on the screen is recorded and plotted on a graph as shown below.

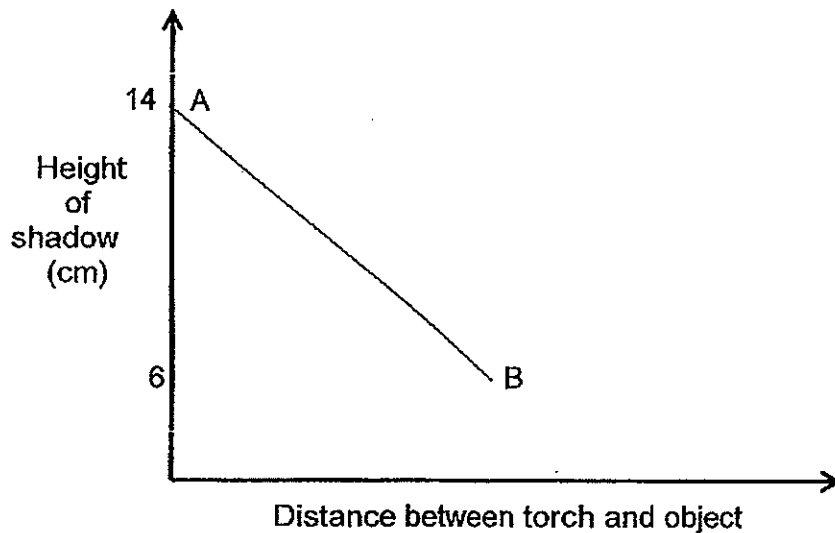
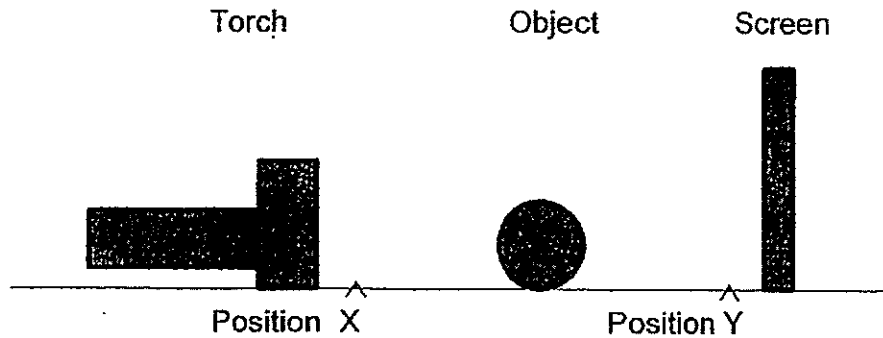

- (a) How is the shadow of the object formed? [1m]
- 
- (b) Is the object placed at position X or Y when the height of shadow is 14cm? [1m]
- 
- (c) Besides moving the object, what could Dawn do to get the height of shadow to change from 6cm back to 14cm? [1m]
- 

(Go on to the next page)

- 37 Peter conducted an experiment using set-ups A and B as shown. He wrapped a glass beaker with material X and another glass beaker with material Y. Both beakers are filled with hot water.

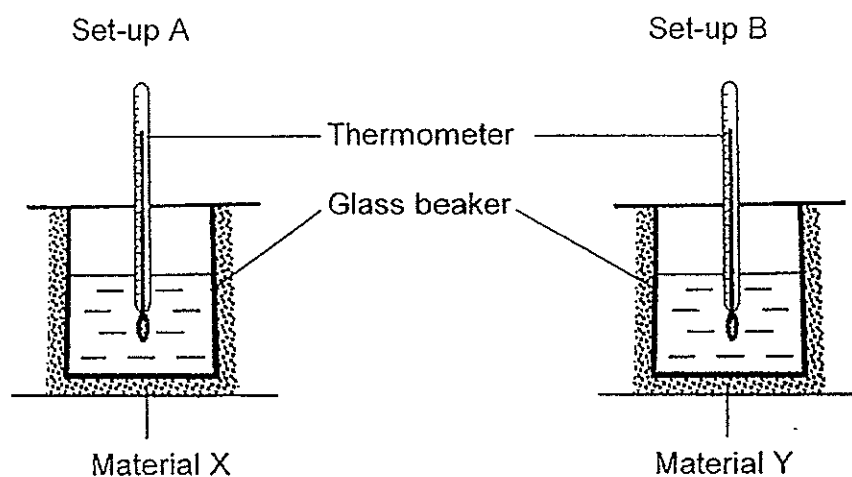

The temperature of the water in set-ups A and B are measured at different times and the results are shown in the graph below.

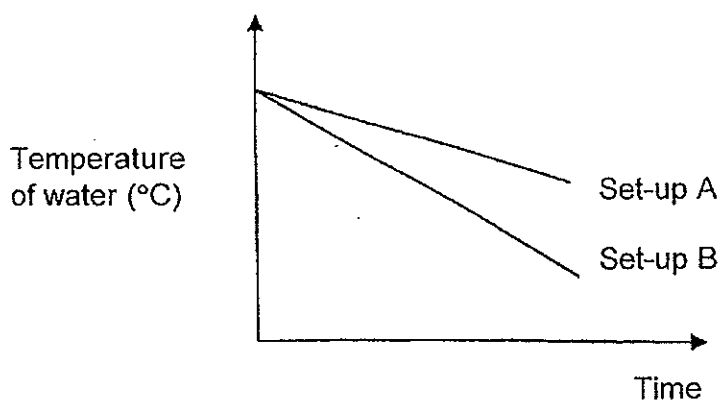

- (a) Based on the graph, what is the relationship between the temperature of water and time? [1m]

---



---

(Go on to the next page)

- (b) Which material, X or Y, is better at keeping a drink warm for a longer time? Why? [2m]

---

---

- (c) Name an example of the material you have chosen for (b). [1m]

---

- (d) List 2 conditions that Peter has to keep constant in order for the experiment to be a fair test. [2m]

(i) \_\_\_\_\_

(ii) \_\_\_\_\_

- 38 Rosnah heated 100ml of tap water over a burner and took the temperature of the water every 4 minutes for 20 minutes. She then plotted the graph below.

Temperature ( $^{\circ}\text{C}$ )

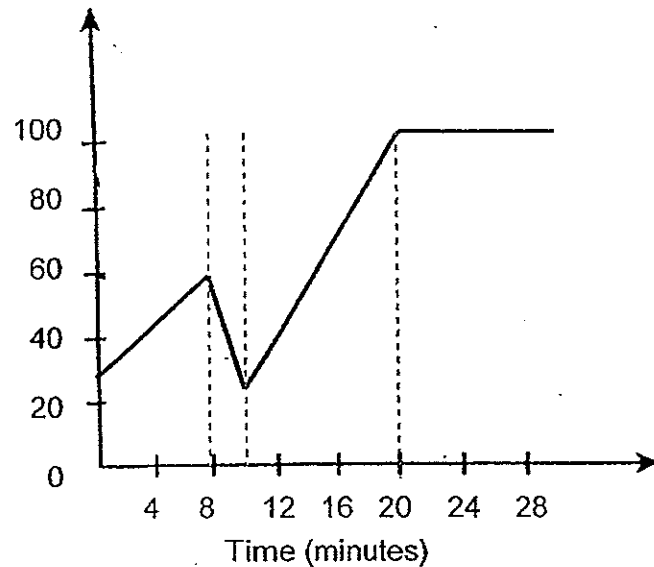

- (a) Explain why the temperature of the water changed in the first 8 minutes when it was heated? [1m]
- 
- (b) Without turning off the burner, what could Rosnah have done at the 8<sup>th</sup> minute that caused a sharp drop in the temperature of the water as shown in the graph? [1m]
- 
- (c) Would the amount of heat at 100 $^{\circ}\text{C}$  be the same if the amount of water is increased from 100ml to 200ml from the start? Explain your answer. [1m]
- 

End of Paper



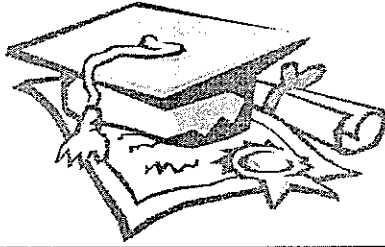

# ANSWER SHEET

**EXAM PAPER 2014**

**SCHOOL : MGS**  
**SUBJECT : PRIMARY 4 SCIENCE**

**TERM : SA1**

Q1	Q2	Q3	Q4	Q5	Q6	Q7	Q8	Q9	Q10	Q11	Q12	Q13	Q14	Q15	Q16	Q17
3	4	1	3	1	3	2	3	3	3	2	3	3	3	3	4	4
Q18	Q19	Q20	Q21	Q22	Q23	Q24	Q25									
2	3	2	4	3	1	1	3									

26. a) F  
b) T  
c) T  
d) F

27. a) It would die.  
b) The grasshopper did not have enough air, living things need air to survive. Therefore the grasshopper died.  
c) Loosen the cap

28. a) Mano is wrong. Although they may have some poisonous parts, the fruits are not and are edible.  
b) Plant A has edible fruits but Plant B does not. Plant B has poisonous parts but Plant A does not.  
c) Has edible fruit: Durian tree  
Has flowers: Hibiscus plant, Balsam plant, Durian tree

29. a) The plant grew taller until week 4 and then remained at the same height after that.  
b) The taller adult balsam plant blocked the shorter chilli plant from getting sunlight to enable it to make food and grow.

30. a) Its is warm-blooded, it is a mammal and lays eggs.  
b) The bat  
c) classified under 'give birth to young alive'

31. a) i) Plants  
ii) Fungi  
b) Group R feeds on their host whereas Group P can make their own food.

32. a) C  
b) E  
c) B  
d) D

33. A D F G

34. a) i) North  
ii) South  
b) i) Aluminium is a non-magnetic material. Therefore it will not become a magnet no matter how many times you stroke it.  
ii) Magnetic material. Iron.

35. a) i) B: \_\_\_\_\_  
C: \_\_\_\_\_  
ii) Due to the stopper, there is air that occupies space in A. However in D, because there is no stopper, there is no air that occupies space.  
iii) Remove the stopper in A  
b) i) water has no definite shape  
ii) Water level is always parallel to the ground

36. a) The shadow of the object is formed when light is blocked by the object.  
b) Position X  
c) Move the torch closer to the object.

37. a) The longer the water is left out, the colder it becomes.  
b) Material X. The temperature of the water drops slower over the same duration when the beaker is wrapped with Material X than when it is wrapped with Material Y.  
c) Wool  
d) i) The amount of water  
ii) The amount of time

38. a) When the water is heated, it gains heat and thus the temperature will rise.  
b) Ice water is added to the water.  
c) No. There is more heat in 200ml of water as more heat is needed to heat a greater amount of water to 100°C.