

NANYANG PRIMARY SCHOOL

PRIMARY 4 SCIENCE

SEMESTRAL ASSESSMENT 1
2010

BOOKLET A

Date: 11 May 2010

Duration: 1 h 45 min

Name: _____ ()

Class: Primary 4 ()

Marks Scored:

| | | |
|-------------|--|-----|
| Booklet A: | | 60 |
| Booklet B : | | 40 |
| Total : | | 100 |

Parent's signature: _____

**DO NOT OPEN THIS BOOKLET UNTIL YOU ARE TOLD TO DO SO.
FOLLOW ALL INSTRUCTIONS CAREFULLY.**

Booklet A consists of 21 printed pages including this cover page.

Section A (30 x 2 marks = 60 marks)

For each question from 1 to 30, four options are given. One of them is the correct answer. Make your choice (1, 2, 3 or 4).

Shade the correct oval (1, 2, 3 or 4) on the Optical Answer Sheet provided.

1. Shawna filled a 5 ml syringe with a gas, K. She pressed the nozzle of the syringe against the wall and pushed hard on plunger Z as shown in the diagram below.

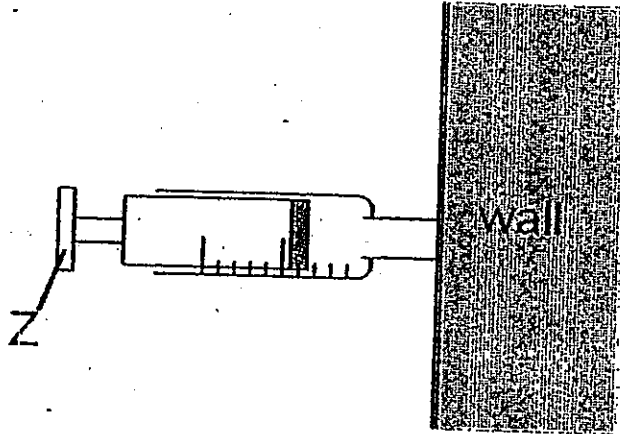

She observed that the volume of gas became 3 ml.

Assuming that no gas escaped from the syringe, which of the following could be Shawna's conclusions?

- A Gas K has shape.
- B Gas K has mass.
- C Gas K can be compressed.
- D Gas K has no definite volume.

(1) C and D only

(2) A, B and C only

(3) B, C and D only

(4) A, B, C and D

2. Four rectangular blocks W, X, Y and Z were of the same size but made of different materials. They were hung on String A and String B on a lever balance, two at a time, as shown below.

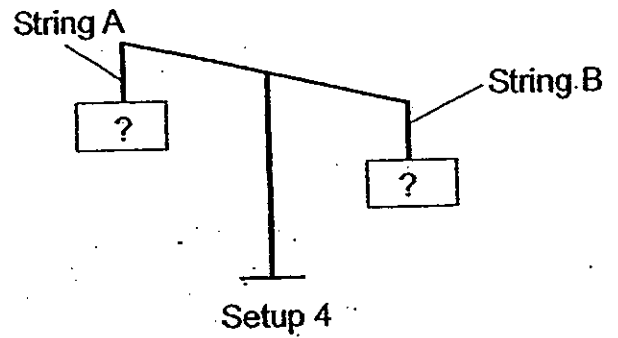
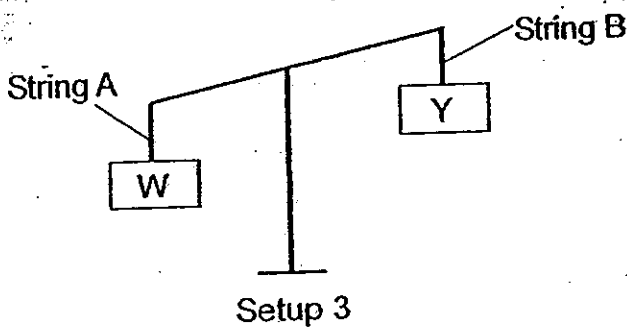
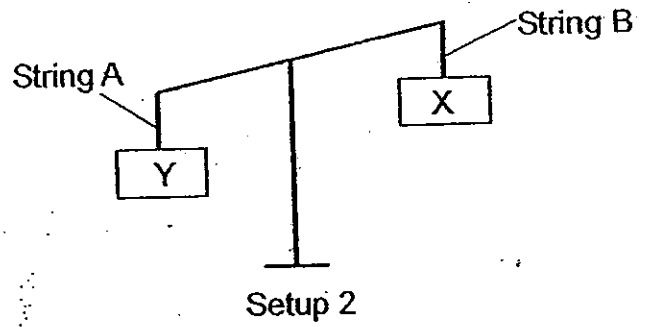
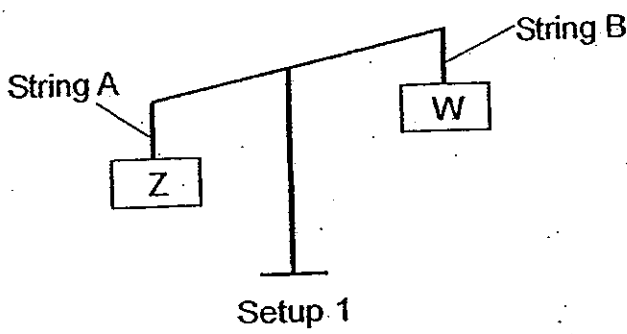

Which of the following rectangular blocks W, X, Y or Z were hung on String A and String B in Setup 4?

| | String A | String B |
|-----|----------|----------|
| (1) | W | X |
| (2) | X | Z |
| (3) | Z | Y |
| (4) | Z | X |

3. Rajit wanted to find out the volume of a stone which he had dropped into a cylinder of water containing a marble as shown below.

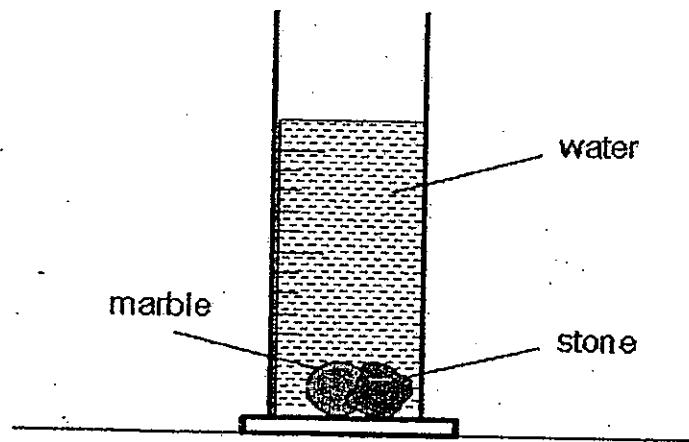

Rajit had taken down the following measurements, A, B, C and D.

- Measurement A: Volume of water only
Measurement B: Volume of marble only
Measurement C: Total volume of water and marble only
Measurement D: Total volume of water, marble and stone

Which of the above measurements are needed for Rajit to calculate the volume of the stone?

- (1) D only
(2) A and B only
(3) B and C only
(4) C and D only

4. Li Ling had to conduct some investigations to answer some questions she had. She found some materials in the Science Laboratory as shown below.

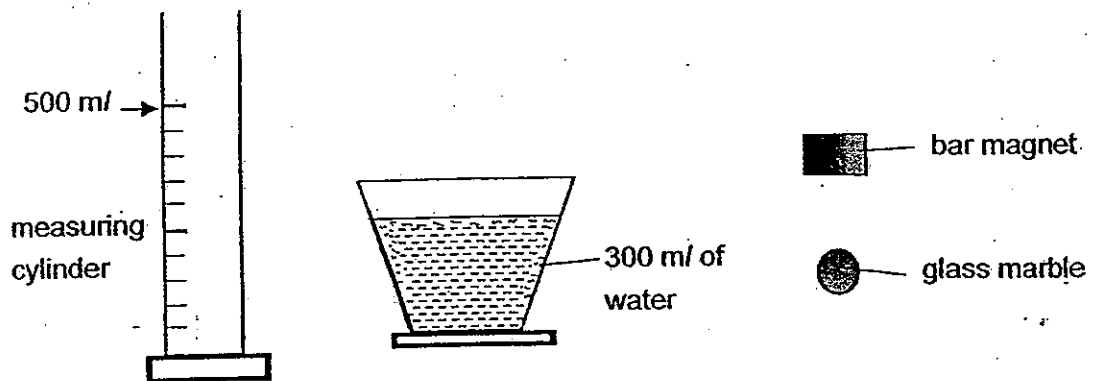

Li Ling could only use the materials shown above for her investigations. Which of the following question(s) would Li Ling not be able to answer?

- A Is the volume of the bar magnet 100 cm^3 ?
- B Does the glass marble float or sink in water?
- C Is the bar magnet taking up more space than the glass marble?
- D Does the glass marble have a greater mass than the bar magnet?

- (1) D only
- (3) C and D only

- (2) A and C only
- (4) A, B and C only

5. Angeline filled three identical balloons A, B and C separately with a solid, a liquid and a gas. She then used a weighing balance to compare the mass of the balloons. Her results are shown below.

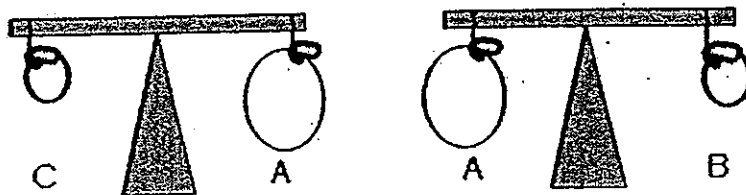

Based only on her results, which of the following statements is correct?

- (1) Balloon A is filled with a solid.
- (2) Balloon C is filled with a liquid.
- (3) Balloon C and B have the same volume.
- (4) Balloon C contains matter of the same mass as that in balloon B.

6. The diagram below shows a decorative item consisting of a plastic toy fish hung from end P and three similar metal rods hung from end Q.

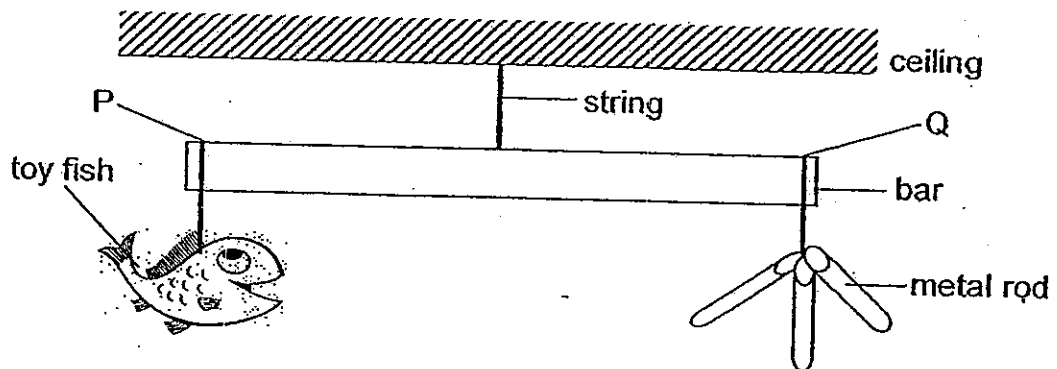

If the bar was balanced on both sides, which of the following statements is /are **wrong**?

- A If one metal rod was removed, end P would be lower than end Q .
- B The plastic toy fish had a greater mass than one metal rod.
- C The plastic toy fish had the same volume as the three metal rods.
- D If another identical metal rod was added to both end P and end Q, the bar would still be balanced.

(1) B only
(3) A and D only

(2) C only
(4) C and D only

7. At room temperature, which one of the following options consists of only liquid ?

- (1) apple juice, milk, salt
- (2) sugar, ice, ice cream
- (3) smoke, perfume, coffee
- (4) cooking oil, water, shampoo

8. Which of the following statements about matter and non matter are true ?

- A All matter can be seen.
- B Matter occupies space but non- matter does not.
- C Non-matter does not have mass while matter has mass.
- D Living things are non matter while non- living things are matter.

- (1) A and B only
- (2) B and C only
- (3) C and D only
- (4) A, B, C and D

9. Farah carried out four different experiments, A, B, C and D. The diagrams below show the results of her experiments.

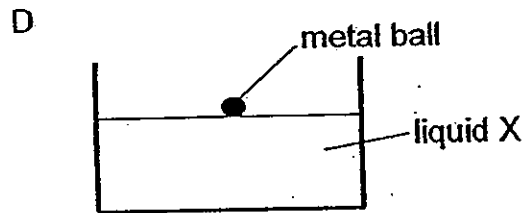
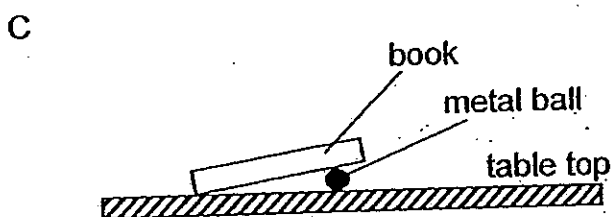
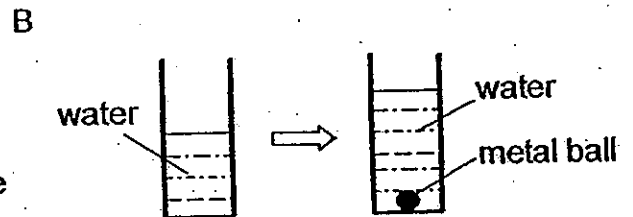
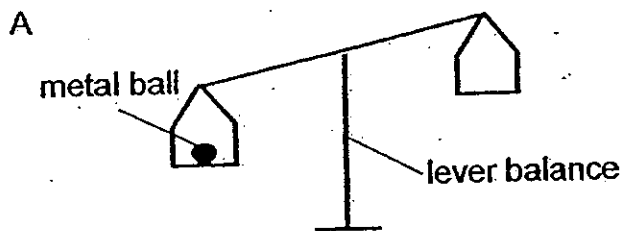

Which of the experiments A, B C or D allowed Farah to conclude that the small metal ball is a matter?

- (1) A only
- (2) B and D only
- (3) A, B and C only
- (4) A, B, C and D

10. The diagram below shows a glass vessel.

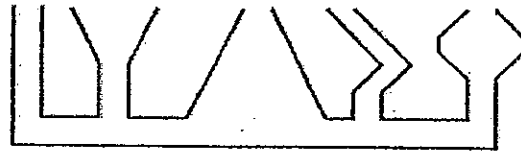

Which of the following correctly shows the water level when the glass vessel is filled with some water ?

(1)

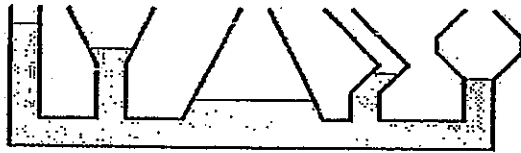

(2)

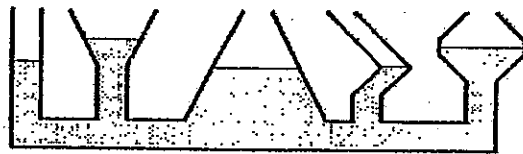

(3)

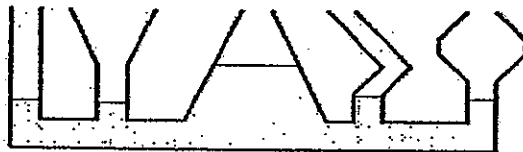

(4)



11. The diagram below shows a pair of spectacles.



Subha carried out some tests on a few materials, K, L, M or N to find out which was most suitable for making the frame of a spectacle.

Test A: Bending the materials

Test B: Stretching the materials

Test C: Shining light through the materials

Test D: Finding out if the materials could float on water

Which of the following test(s) is/ are necessary?

(1) A only

(2) B and D only

(3) A, B and C only

(4) B, C and D only

12. Hermione set up an experiment as shown below.

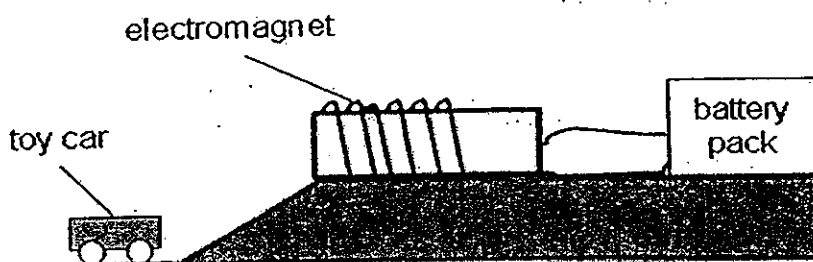

When the switch was turned on, the steel toy car was attracted up the ramp towards the electromagnet. What changes could she make so that the time taken for the car to reach the electromagnet would decrease?

(1) Use a heavier toy car.

(2) Use the other end of the electromagnet.

(3) Increase the number of batteries in the battery pack.

(4) Decrease the number of coils around the electromagnet.

13. Shuli wanted to compare the strengths of different magnets, X, Y and Z, using steel paperclips. Her observations are shown below.

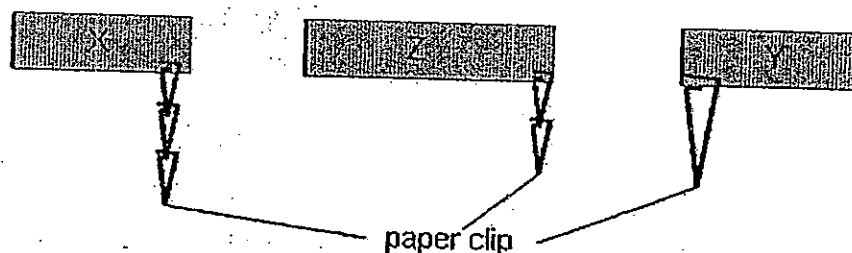

Her classmates made the following statements to explain why her experiment was not a fair one.

- | | |
|-----------|--|
| Ai Ling | "It is not a fair test because the sizes of the magnets are different." |
| Bao Jiao | "The number of paperclips is different!" |
| Charles | "It is not fair as the paperclips are attracted to different ends of the magnets." |
| Dong Zhuo | "The experiment is not fair because the size of the paperclips is not the same." |

Which of their statements is /are **incorrect**?

- (1) Charles only
 - (2) Bao Jiao and Charles only
 - (3) Ai Ling, Bao Jiao and Charles only
 - (4) Bao Jiao, Charles and Dong Zhuo only
14. Ali wanted to use the stroking method to make a magnet from a nail. However after stroking the nail with a magnet, Ali found that his nail was not magnetized.

Which of the following is/are possible reason(s) why his nail was not magnetized ?

- A The nail was not made of a magnetic material.
 - B Ali made too few strokes on the nail with the magnet.
 - C Ali only used one end of the magnet to stroke the nail.
- (1) A only
 - (2) C only
 - (3) A and B only
 - (4) A, B and C.

15. The diagram below shows three bar magnets attracted to each other.

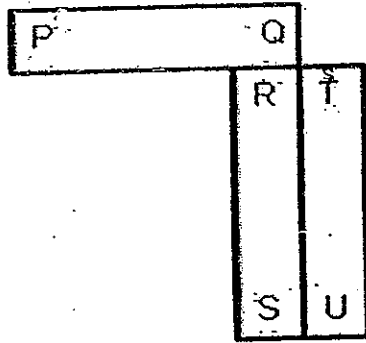

Which one of the following arrangement is a possible arrangement of the magnets when they are placed together?

(1)



(2)



(3)



(4)

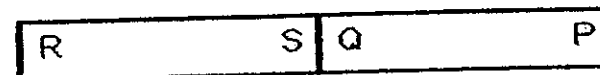

16. Philip set up the experiment shown below. He wanted to find out how the strength of a magnet affects the distance a pin could be placed for the magnet to still be able to attract it.

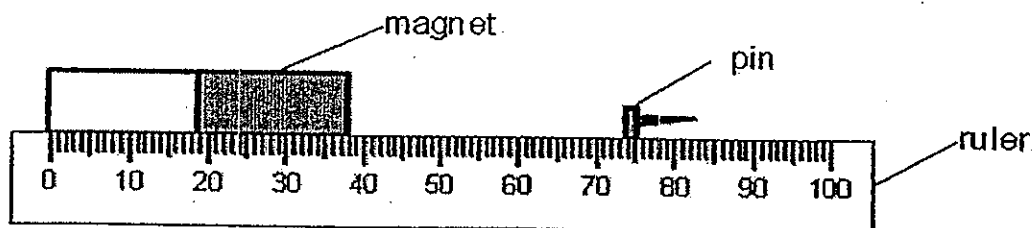

Which of the following could be a hypothesis of his experiment ?

- (1) The lighter the pin, the further the distance the magnet could attract it.
- (2) The greater the strength of the magnet, the further the distance the magnet could attract the pin.
- (3) The longer the magnet, the greater the strength of the magnet.
- (4) The bigger the magnet, the further the distance the magnet could attract the pin.

17. Study the flow chart below.

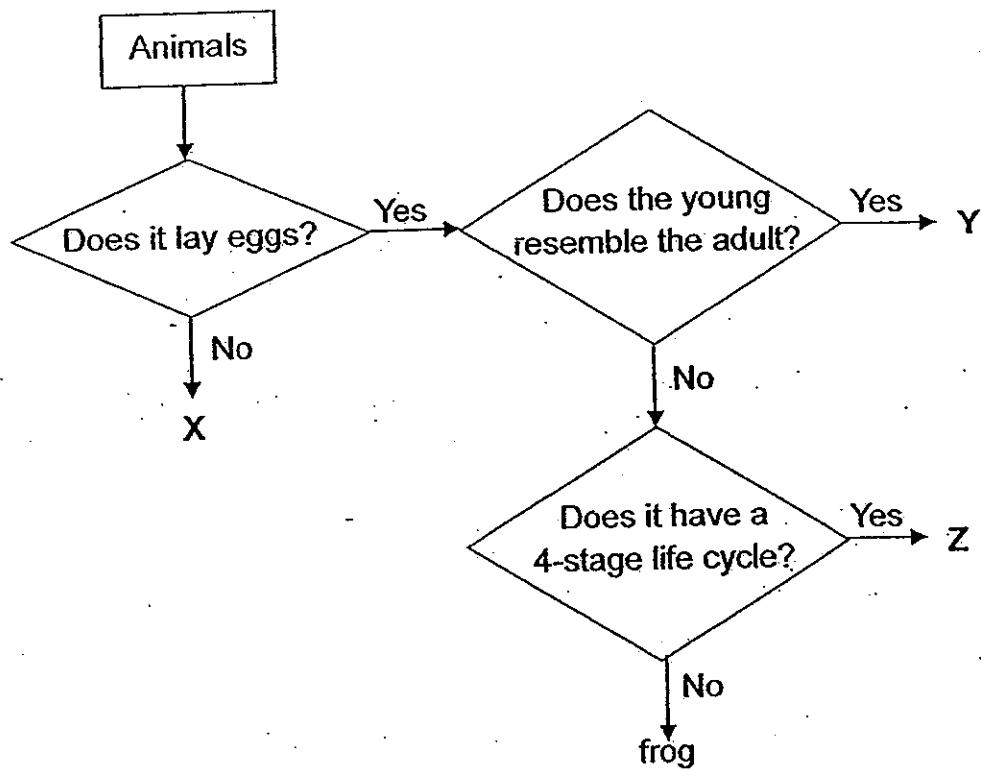

Based on the information given in the flow chart, which of the following animals represent X, Y and Z?

| | X | Y | Z |
|-----|----------|-------------|-----------------|
| (1) | Molly | Grasshopper | Cockroach |
| (2) | Platypus | Cockroach | Butterfly |
| (3) | Bat | Duck | Mosquito |
| (4) | Lion | Mosquito | Mealworm beetle |

Study the life cycle of organism P as shown below and answer questions 18 and 19.

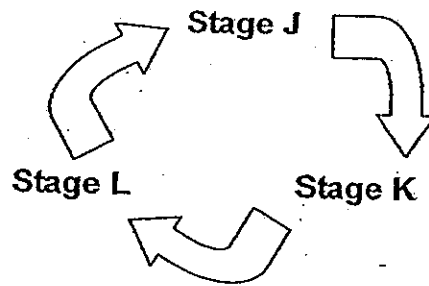

18. Which one of the following living things does not have a life cycle of similar number of stages as organism P ?
- (1) Grasshopper
 - (2) Angsana tree
 - (3) Spiny anteater
 - (4) Mealworm beetle
19. If stage K is the seed stage of a durian tree, at which stage(s) do/does the plant need sunlight to grow well?
- (1) Stage J only
 - (2) Stage K only
 - (3) Stage J and L only
 - (4) Stage J, K and L

20. Study the classification below.

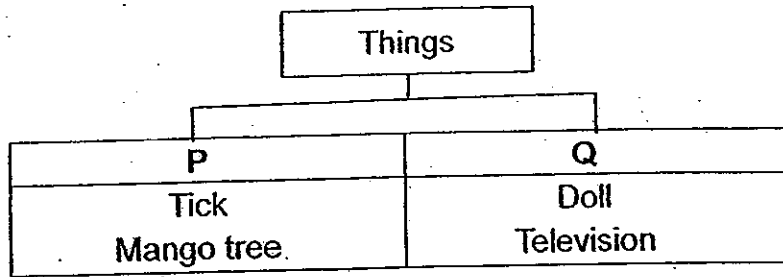

Which of the following headings best represent headings P and Q?

| | Heading P | Heading Q |
|-----|-------------------------------------|--|
| (1) | Can move freely from place to place | Cannot move freely from place to place |
| (2) | Can make their own food | Cannot make their own food |
| (3) | Can respond to changes | Cannot respond to changes |
| (4) | Can produce sounds | Cannot produce sounds |

21. Nora was asked by her Science teacher to classify the following animals into three groups.

- Bat ● Tadpole ● Swordtail ● Silverfish ● Cockroach nymph

Which of the following characteristics could Nora use to classify the animals into three groups?

- A: Number of legs
- B: Number of wings
- C: Type of movement

- | | |
|------------------|---------------------|
| (1) A only | (2) A and C only |
| (3) B and C only | (4) A, B and C only |

22. Sumin collected some data about organisms P and Q and recorded it in a table. A tick (✓) means that the organism has the characteristic stated.

| Characteristic | P | Q |
|---|---|---|
| Its young has wings | | ✓ |
| Has 3- stage life cycle | | ✓ |
| Has 4- stage life cycle | ✓ | |
| Spends at least one stage of its life cycle in water. | ✓ | |

Based on the information above, which of the following statements accurately describe organism(s) P and/or Q?

- A: Q can fly.
- B: P and Q are insects
- C: P and Q feed on other animals.
- D: An example of P is the mosquito.

(1) D only

(2) B and D only

(3) A, B and C only

(4) A, B, C and D

23. Study the classification chart below.

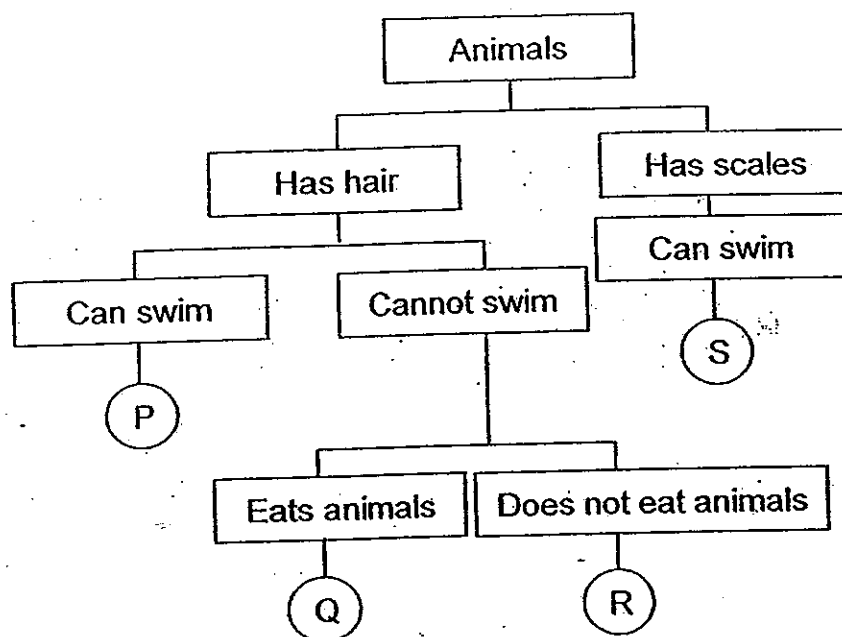

Victoria went to the zoo and drew the classification chart above based on her observations on Animals P, Q, R and S. Which of the following statement(s) is/are true?

- A Animals Q and R can fly.
- B Animals Q and R live on land.
- C Animals P, Q and R are mammals.
- D Animals P and S can stay under water all the time.

- (1) D only
- (2) A and B only
- (3) B and C only
- (4) A, C and D only

24. Jimmy saw an organism W in his bedroom. Which of the following observations would be helpful to him to find out if W is an insect?

- A The number of legs it has.
- B The number of wings it has.
- C The number of eyes it has.
- D The number of parts its body is divided into.

- (1) A and D only
- (2) B and C only
- (2) C and D only
- (4) A, B and C only

25. The diagram below shows the head of a fish with the gill cover removed. S, T and U are parts of the fish.

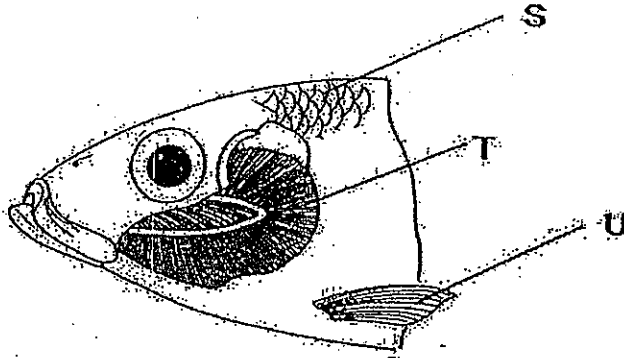

Which of the following correctly states the functions of S, T and U ?

| | S | T | U |
|-----|---------------------------|------------------------|----------------------|
| (1) | Senses the surrounding | Takes in food | Helps it to hide |
| (2) | Protects the body | Takes in dissolved air | Helps it to swim |
| (3) | Helps it swim | Helps it take in water | Protects the body |
| (4) | Helps it hide from danger | Helps it to float | Helps it to lay eggs |

26. Ethan carried out an experiment using 20 mealworms and four pieces of bread of the same size as shown below. The mealworms were placed in the centre of a tray which was divided into four equal parts of dark and bright areas.

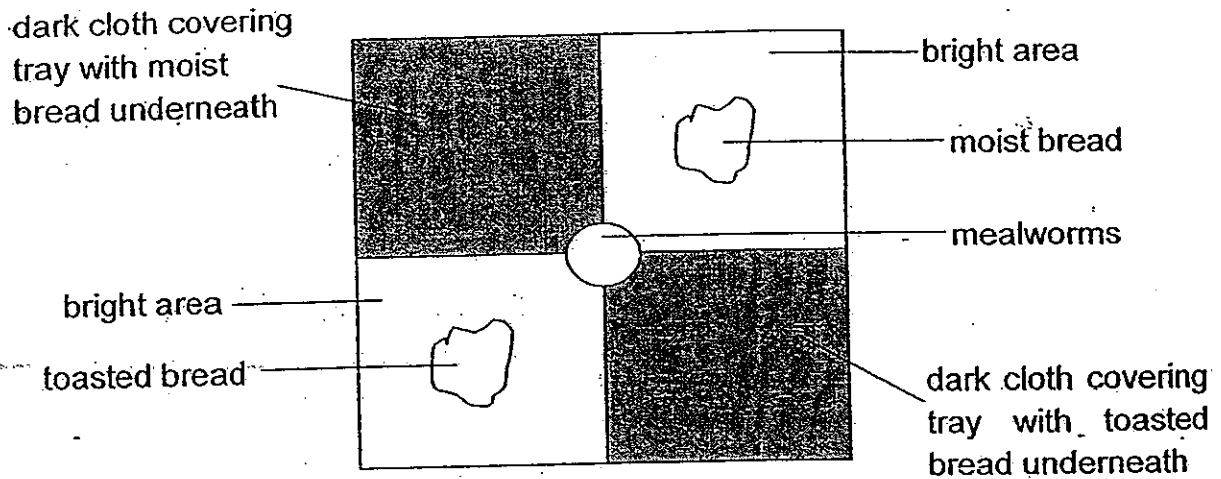

After 1 hour, Ethan recorded the number of mealworms found in the different parts of the tray as shown in the table below.

| | Dark area with moist bread | Dark area with toasted bread | Bright area with moist bread | Bright area with toasted bread |
|---------------------|----------------------------|------------------------------|------------------------------|--------------------------------|
| Number of mealworms | 14 | 2 | 4 | 0 |

Which of the following conclusions can Ethan make from his experiment?

- A Mealworms need water.
- B Mealworms will eventually die.
- C Mealworms can move about freely.
- D Mealworms can sense the surrounding.

- (1) B only
- (3) B and D only

- (2) A and D only
- (4) A, C and D only

27. Study the classification table below.

| Animal with feathers | | Animals without feathers | |
|----------------------|------------|--------------------------|------------|
| Can fly | Cannot fly | Can fly | Cannot fly |
| W | X | Y | Z |

Which one of the following statements about animals W, X, Y or Z is true?

- (1) Animal W is a bat.
- (2) Animals Y and Z cannot swim.
- (3) Animal Y can only be an insect.
- (4) Animals W and X have a pair of wings.

28. The diagram below shows a cactus which is a plant that grows in the desert.

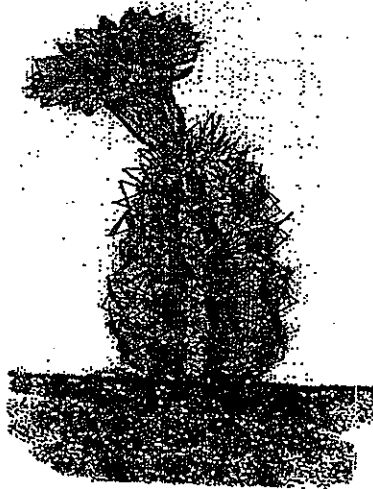

Which of the following statements is/are true about the cactus?

- A It is a type of fern.
 - B It can make its own food.
 - C It does not need water as it lives in the desert.
- (1) B only
 - (2) C only
 - (3) A and C only
 - (4) A, B and C.

29. Which one of the following statements is true about moss and fern ?

- (1) They both only grow on trees.
- (2) They both reproduce from spores.
- (3) They both do not make their own food.
- (4) They both have stem, roots and leaves.

30. Which of the following is/are the reason(s) why a mango tree produce flowers ? -

- A To grow into an adult plant
- B To produce food for animals
- C To respond to changes in its surrounding
- D To reproduce to ensure the continuity of its kind

- (1) B only
- (2) D only
- (3) A, B and D only
- (4) A, B, C and D

NANYANG PRIMARY SCHOOL

PRIMARY 4 SCIENCE

**SEMESTRAL ASSESSMENT 1
2010**

BOOKLET B

Date : 11 May 2010

Duration : 1 h 45 min

Name : _____ ()

Class: Primary 4 ()

Marks Scored:

| | | |
|--------------------|--|------------|
| Booklet A: | | 60 |
| Booklet B : | | 40 |
| Total : | | 100 |

Parent's signature: _____

**DO NOT OPEN THIS BOOKLET UNTIL YOU ARE TOLD TO DO SO.
FOLLOW ALL INSTRUCTIONS CAREFULLY.**

Booklet B consists of 13 printed pages including this cover page.

Section B (40 marks)

Write your answers to questions 31 to 44 in the spaces provided.
Marks will be deducted for misspelt key words.

31. Junhua carried out an experiment as shown below. He pushed a transparent plastic cup over a floating piece of wooden block until the plastic cup touched the bottom of the tank.

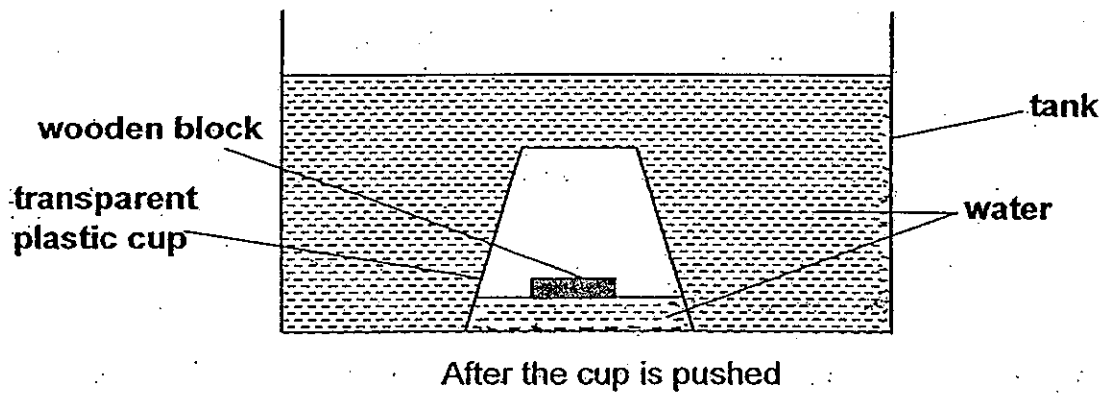
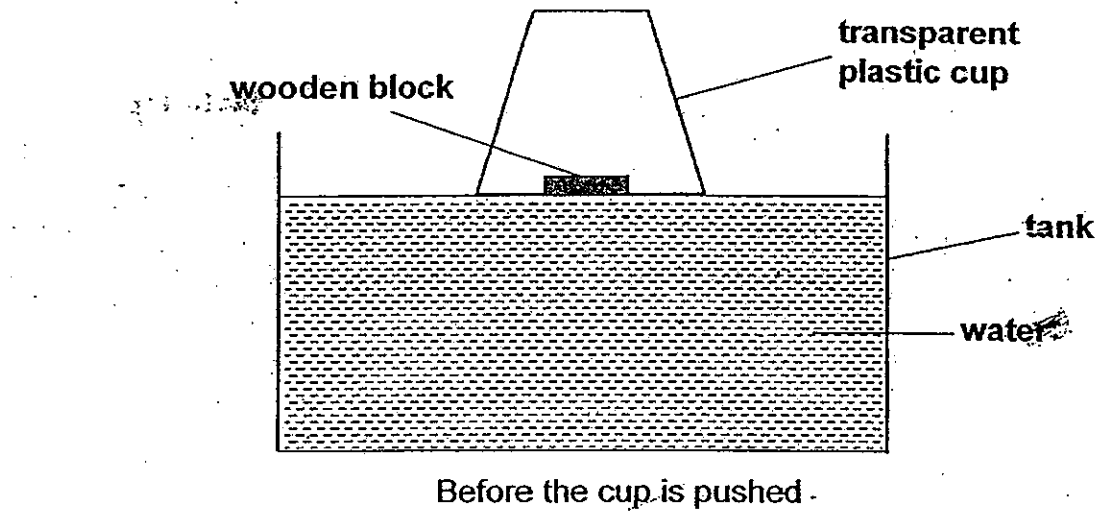

Junhua then repeated the experiment by cutting a hole at the base of the plastic cup. In the diagram below, draw the water levels and position of the wooden block when Junhua pushed the plastic cup to the bottom of the tank. [2]

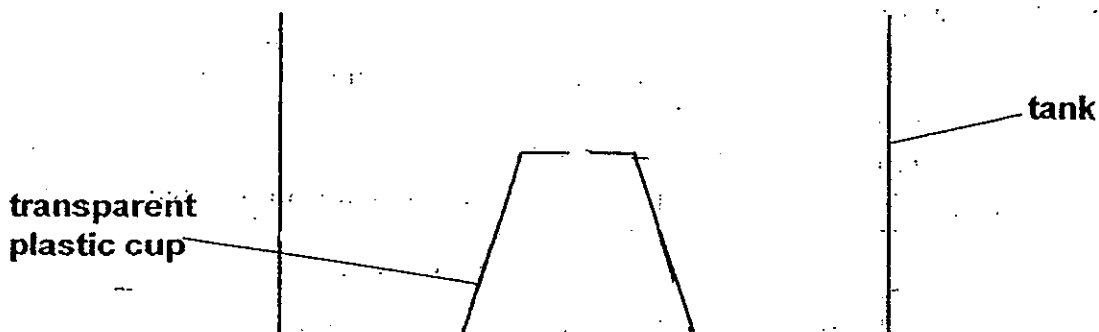

32. Kai Jie wanted to compare the mass of three similar Objects Y and three similar Objects Z using a lever balance. Before the start of his experiment, he made sure that Pan P and Pan Q were balanced. Distance d was the distance between the bottom of the pans and the table top.

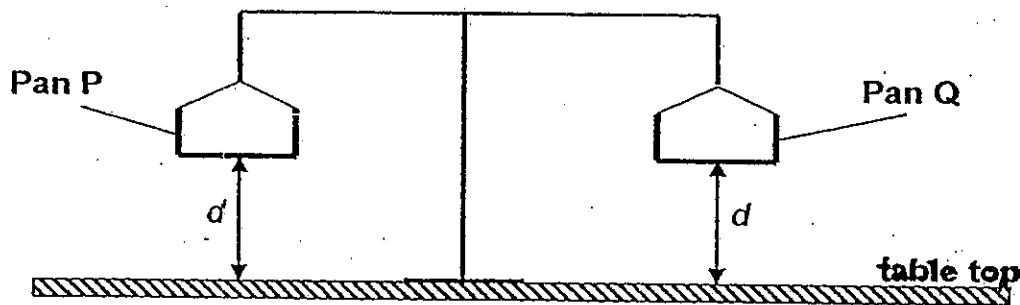

Kai Jie then placed one Object Y on Pan P and one Object Z on Pan Q. He measured and recorded Distance d for both pans. He repeated the steps until all three Object Y were placed on Pan P and three Object Z were placed on the Pan Q. The following shows the graph that Kai Jie plotted after the experiment.

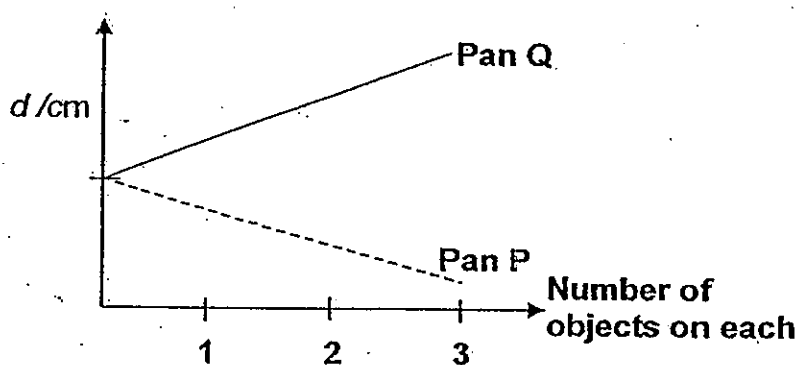

- (a) Based on the graph, compare the mass of one Object Y and the mass of one Object Z. [1]

- (b) State the relationship between the number of objects on Pan Q and distance d . [1]

- (c) Kai Jie realised that he could not compare the mass of more than three objects on each pan. Explain why this is so. [1]

33. Muthu poured 50 ml of water into each of two containers of different sizes, J and K. The two containers were then placed on a scale and they balanced each other as shown below.

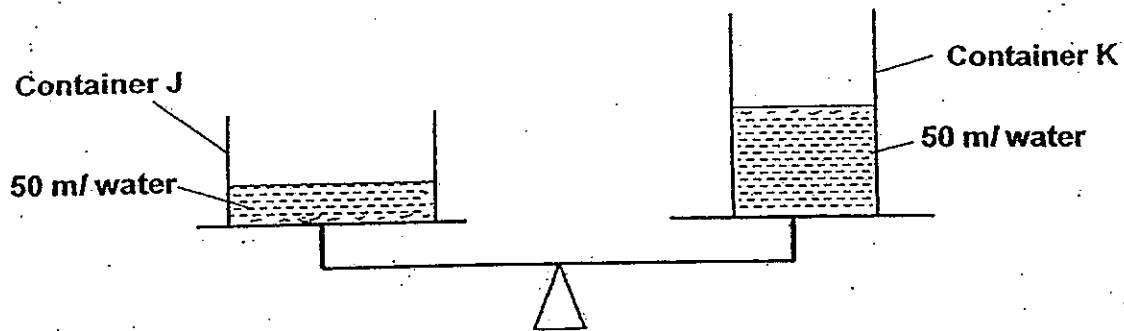

For each of the following statements below, put a tick [✓] in the correct box to indicate if the statements are True, False or Not possible to tell. [4]

| | | True | False | Not possible to tell |
|-----|---|------|-------|----------------------|
| (a) | The water in each of the containers has the same mass. | | | |
| (b) | Containers J and K can hold the same amount of water when filled to the brim. | | | |
| (c) | Container J and Container K were made of different materials. | | | |
| (d) | Muthu can conclude from this experiment that liquid has a definite shape. | | | |

34. Study the flowchart below which is used to classify material A, B, C and D.

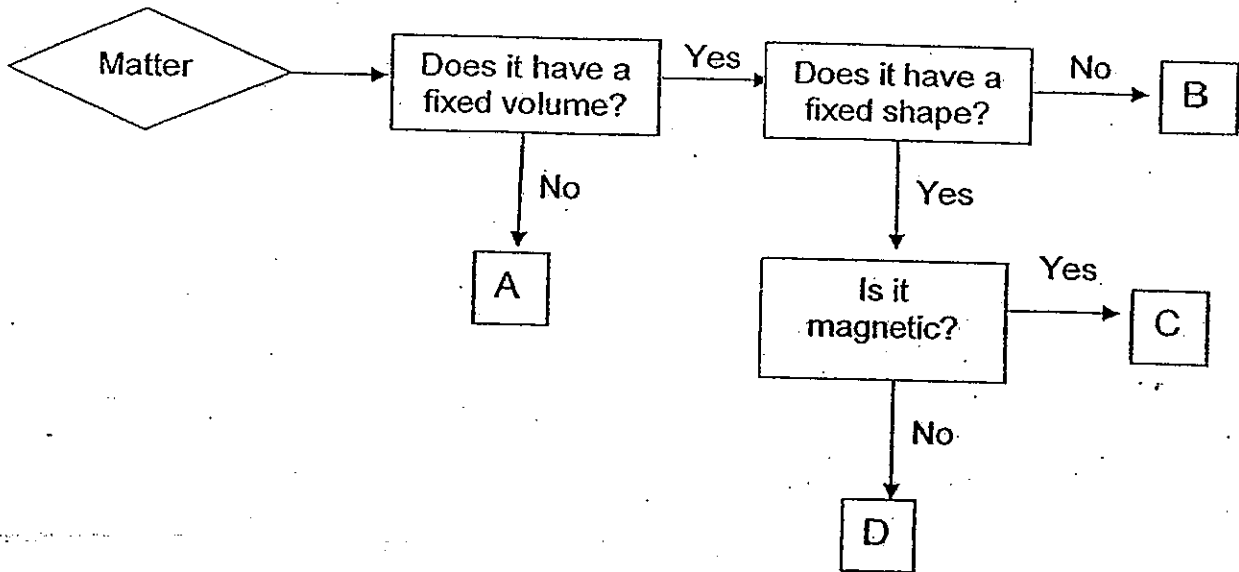

(a) Based on the information given in the flowchart, which material A, B, C or D represents water? [1]

(b) Based on the information given in the flowchart, list the properties of C. [1]

Study the experimental set up below. Only Bar 2 and Bar 3 can swing freely.

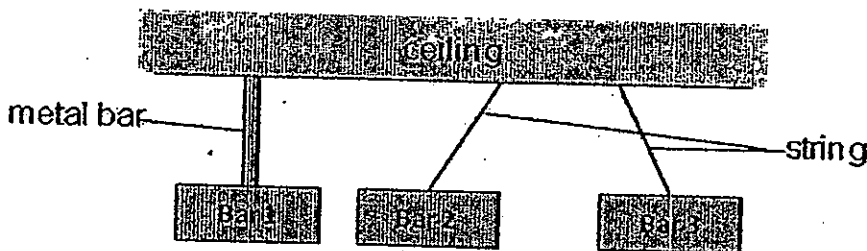

(c) Based on the diagram and the flowchart above, which material, A, B, C or D is Bar 2 mostly likely to be made of? [1]

Material _____

35. Shane carried out several investigations using the container shown below.

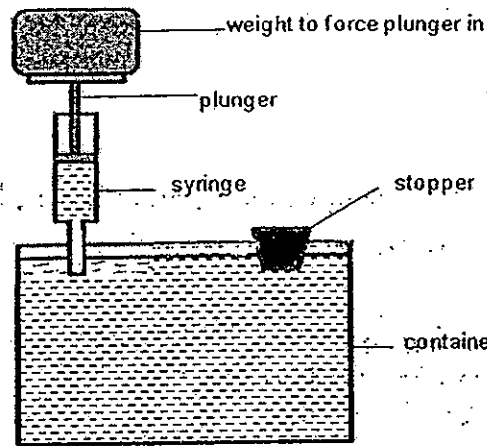

He filled the container with water and used the stopper to seal the container. Then he attached a syringe with water to the container. He placed a 1-kg weight on the plunger and observed the amount of water that could be forced into the container. He repeated the experiment twice using different weight.

Next he poured all the water away and dried the container. He sealed the container with the stopper and repeated his experiment.

He recorded his results in the tables below.

Table 1 : Container with water in it

| Weight used to force plunger in /kg | Amount of water forced into container / ml |
|-------------------------------------|--|
| 1 | 0 |
| 2 | 0 |
| 3 | 0 |

Table 2 : Container with air in it

| Weight used to force plunger in /kg | Amount of water forced into container / ml |
|-------------------------------------|--|
| 1 | 0 |
| 2 | 0.5 |
| 3 | 0.5 |

(a) Based on his result, what can Shane conclude about the property of liquid and gas? [2]

Shane poured hot wax to fill the container and left it to cool to form a solid. He repeated his experiment again.

- (b) How much water would he be able to force into the container? Explain your answer. [1]

36. Betty has three pieces of fabrics P, Q and R. They were made of different material but of similar size and thickness. She covered a glass beaker with a piece of the fabric as shown below.

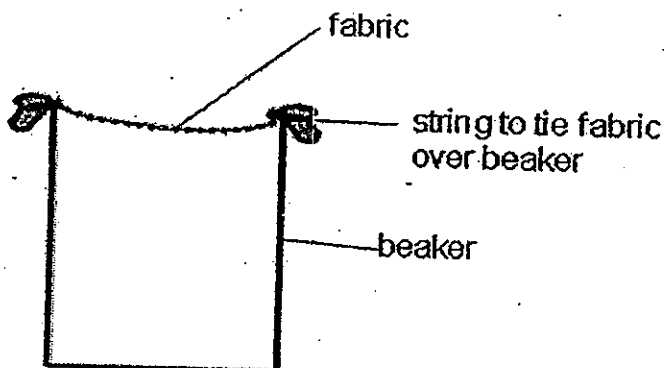

She poured 20 ml of water onto the fabric and waited for the water to flow through it until no more water dripped from the fabric into the beaker. She measured the volume of water collected and also weighed the fabric to find out its weight when it was wet. Betty repeated the experiment on the other two pieces of fabric and recorded her results in the table below.

| Fabric | Amount of water collected in beaker /ml | Weight of dry fabric /g | Weight of wet fabric /g |
|--------|---|-------------------------|-------------------------|
| P | 0 | 4 | 4.1 |
| Q | 19 | 5 | 6.0 |
| R | 10 | 6 | 16.0 |

- (a) Which fabric P, Q or R is the best for making a raincoat? Explain your choice. [1]

- (b) Which fabric P, Q or R is best for making cloth for drying wet dishes? Explain your choice. [1]

37. Billy wanted to show that there is air in garden soil. He had a pot of garden soil and a tank of water.

(a) How could Billy use the tank of water and the pot of garden soil to show that there was air in garden soil? [1]

(b) What did he observe that showed that there was air in the garden soil? [1]

(c) Give one reason why it is important that there is air in soil. [1]

38. The diagram below shows two set-ups, A and B.

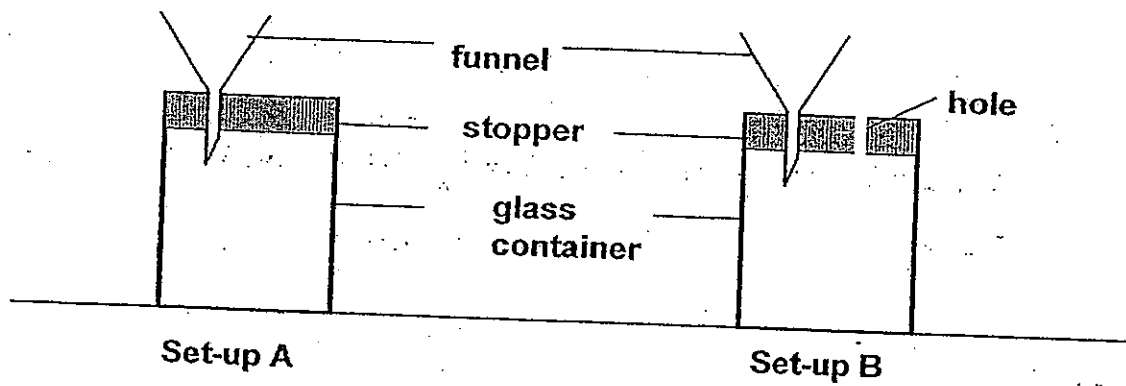

It was found that when water was poured into the funnel, the water flowed into container in Set-up B faster than in Set-up A.

(a) Explain why water could flow easily from the funnel into the container in Set-up B.

[1]

Kim found that it was difficult to pour milk out of a can if only one hole was made.

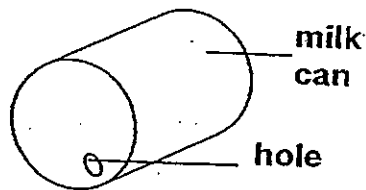

(b) Which one of the cans shown below would allow milk to be poured out of it the fastest?

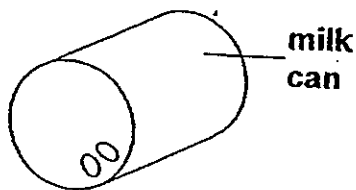

E

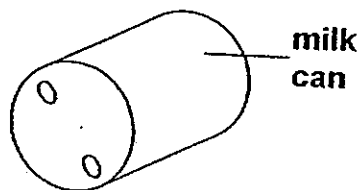

F

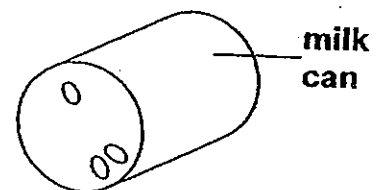

G

Can _____ allows milk to flow out the fastest.

[1]

(c) Explain your choice in (b).

[2]

39. The diagram below shows 3 discs A, B and C. Discs A and C are magnets.

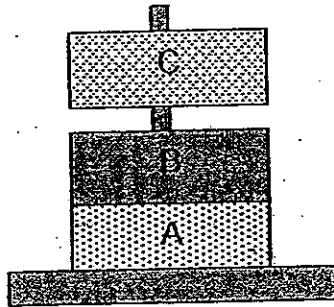

(a) Explain why disc C could float above disc B if B is made of a non-magnetic material.

[2]

(b) Explain why disc C could float above disc B if B is a magnet.

[1]

- 40 Mei Ting received 10 eggs of Insect R from her Science teacher and she was told that the young of Insect R lives in water while the adult lives on land. She placed the eggs in a tank of water and made sure the conditions were just right for the eggs to hatch. Mei Ting noticed that not all the young that hatched from the eggs developed at same rate. After 2 weeks, none of the organisms at each stage died. Mei Ting counted the number of young at each stage in water and plotted the graph below.

Number of organisms in each stage after 2 weeks

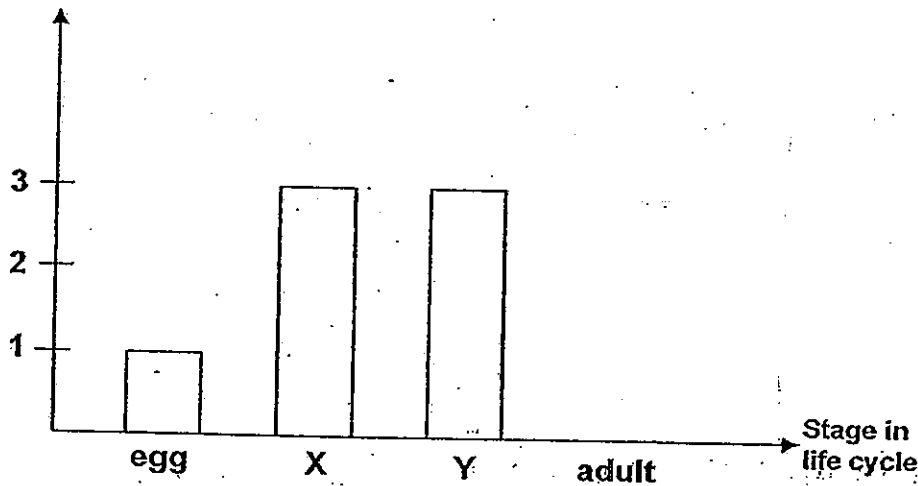

- (a) In the graph above, draw the bar that represents the number of adult Insect R. [1]
- (b) Write down the stages that could be represented by X and Y. [1]

Stage X: _____

Stage Y: _____

- (c) In the box below, draw the life cycle of Insect R using the correct words for each stage. [1]

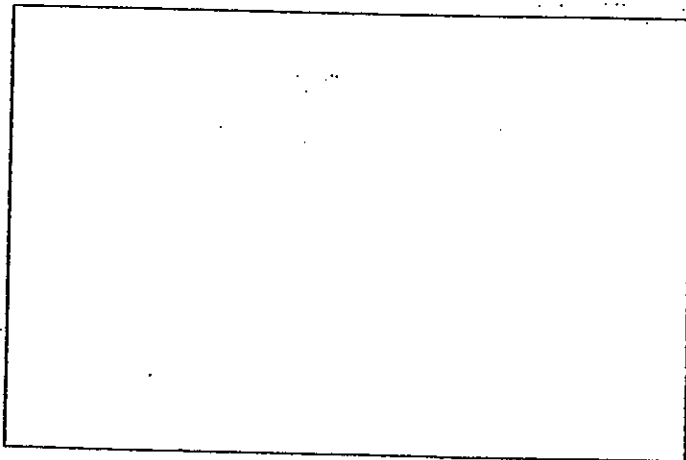

- (d) Explain why one egg in the water did not hatch after 2 weeks. [1]

41. The box below contains the names of several organisms

| | | |
|-------------------|----------|-------------|
| Rice | Mushroom | Moss |
| Lotus | | |
| Dragon scale fern | | Rubber tree |

- (a) Draw a circle around the names of non-flowering plants in the box above. [1]

- (b) How does/do the plant(s) that you have circled in part (a) reproduce? [1]

- (c) In the box below, draw the life cycle of a fern. [1]

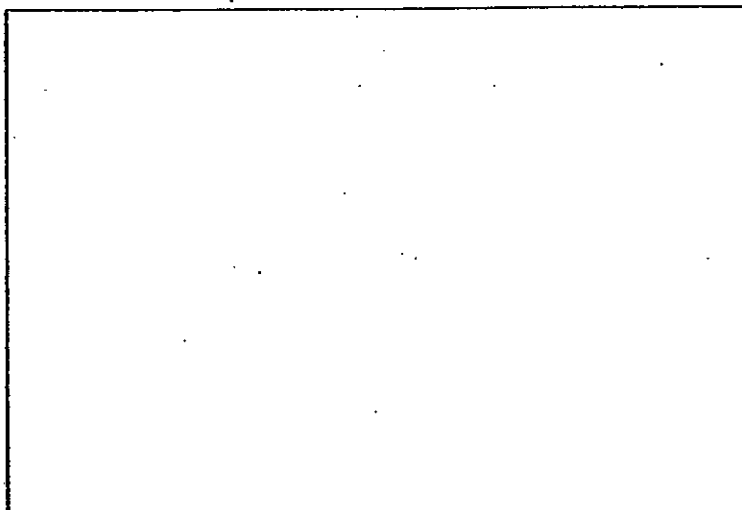

42. (a) Name the part of a plant that anchors the plant into the soil. [1]

(b) Explain why animals have to feed on other organisms. [1]

43 State one similarity and one difference between a frog and a cockroach nymph. (Do not compare their size and physical appearance.) [2]

Similarity: _____

Difference: _____

44. The following diagrams show an adult and one other stage in the life cycle of an insect R.



adult

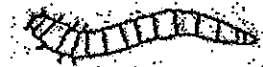

(a) Based on the picture above, is the life cycle of insect R similar to a cockroach ? [1]

(b) Explain your answer in part (a). [1]

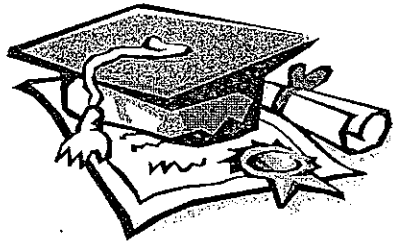

ANSWER SHEET

EXAM PAPER 2010

**SCHOOL : NANYANG PRIMARY
SUBJECT : PRIMARY 4 SCIENCE**

TERM : SA1

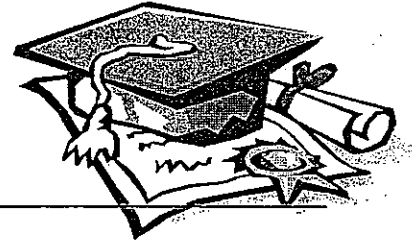

| | | | | | | | | | | | | | | | | |
|----|----|----|----|----|----|----|----|----|-----|-----|-----|-----|-----|-----|-----|-----|
| Q1 | Q2 | Q3 | Q4 | Q5 | Q6 | Q7 | Q8 | Q9 | Q10 | Q11 | Q12 | Q13 | Q14 | Q15 | Q16 | Q17 |
| 1 | 2 | 4 | 1 | 4 | 2 | 4 | 2 | 3 | 4 | 1 | 3 | 2 | 3 | 3 | 2 | 3 |

| | | | | | | | | | | | | |
|-----|-----|-----|-----|-----|-----|-----|-----|-----|-----|-----|-----|-----|
| Q18 | Q19 | Q20 | Q21 | Q22 | Q23 | Q24 | Q25 | Q26 | Q27 | Q28 | Q29 | Q30 |
| 4 | 3 | 3 | 2 | 1 | 3 | 1 | 2 | 4 | 4 | 1 | 2 | 2 |

31)

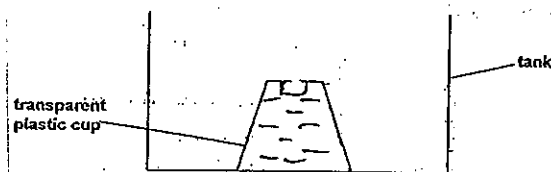

- 32)a)The mass of object Y is greater than the mass of object Z.
 b)The more number of object o Pan Q, the longer distance d is.
 c)When there are four or more object Y on Pan P ,Pan P would have rested on the table top.

33)a)T b)Not c)Not d)F

- 34)a)B
 b)C has a fixed volume a fixed shape and it is magnetic.
 c)C.

- 35)a)Gas has no definite volume but liquid has and gas can be compressed but liquid cannot.
 b)0ml. Solid cannot be compressed, therefore, liquid cannot be forced inside the container.

- 36)a)P. It does not allow water to pass through it and it does not get wet.
 b)R. It allows the most water to pass through it.

- 37)a)Put the pot of oil into the water.
 b)Air bubbles can be seen escaping from the soil.
 c)So roots plants can survive as they need air.

38)a) There is a hole in Set-up B to allow water to flow in to occupy the space left by the air that flows out.

b) G.

c) There are two holes (at the bottom) to allow the milk to flow out faster and a hole (at the top) for air to flow in to occupy space left by milk.

39)a) Magnetism could pass through non-magnetic material and like poles of C and A are facing each other, thus repelling each other.

b) The like poles of C and B are facing each other and thus repelling each other.

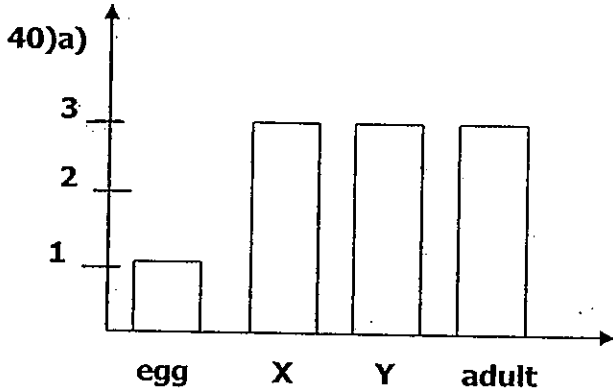

b) X: larva Y: pupa

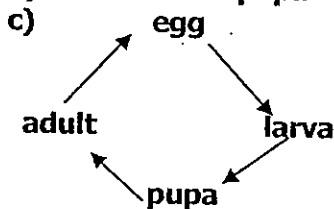

d) The egg was not fertilised./were damaged.

41)a) Moss, Dragon scale fern

b) They reproduce by spores.

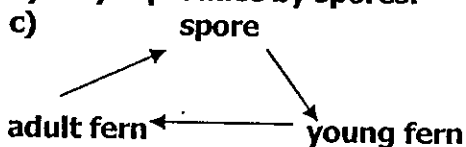

42)a) Roots.

b) They cannot make their own food.

43) Similarity: Both have a three-stage life cycle.

Difference: The young of the frog does not resemble the adult but the cockroach nymph resembles the adult.

44)a) No.

b) The young of R does not look like its adult.