



**NAN HUA PRIMARY SCHOOL
SEMESTRAL ASSESSMENT 1 – 2010
PRIMARY 4**

- SCIENCE

BOOKLET A

30 Multiple Choice Questions (60 marks)

Total Time for Booklets A and B : 1 hour 45 minutes

INSTRUCTIONS TO CANDIDATES

1. Write your name and index number in the space provided.
2. Do not turn over the page until you are told to do so.
3. Follow all instructions carefully.
4. Answer all questions.
5. Shade your answers in the Optical Answer Sheet (OAS) provided.

Marks Obtained

Booklet A	/ 60
Booklet B	/ 40
Total	/100

Name: _____ () Class: P 4 _____

Date : 12 May 2010

Parent's Signature: _____

Section A: (30 x 2 marks = 60 marks)

For each question from 1 to 20, four options are given. One of them is the correct answer. Make your choice (1, 2, 3 or 4). Shade the correct oval (1, 2, 3 or 4) on the Optical Answer Sheet.

1. A source of light is anything that _____
- 1) reflects light
 - 2) refracts light
 - 3) absorbs light
 - 4) gives off light of its own

2. Refer to the set-up below.

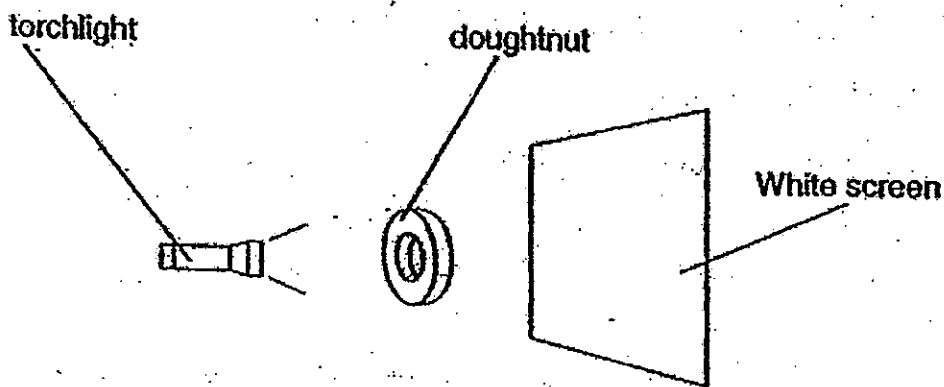

What is the shadow formed on the screen?

1)



2)



3)

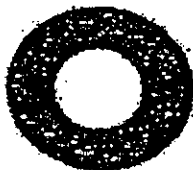

4)

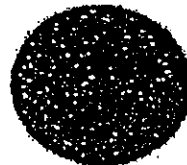

3. Which one of the following spoons is the best conductor of heat?

- 1) Wood
- 2) Metal
- 3) Plastic
- 4) Porcelain

4. The diagram below shows a spoon at 75°C being put into a beaker of water at 30°C . Which of the following changes do you think will happen to the water after the spoon is put into it?

- A: The water level will rise.
- B: The water will lose heat to the spoon.
- C: The volume of the water will increase.
- D: The temperature of the water will fall below 30°C

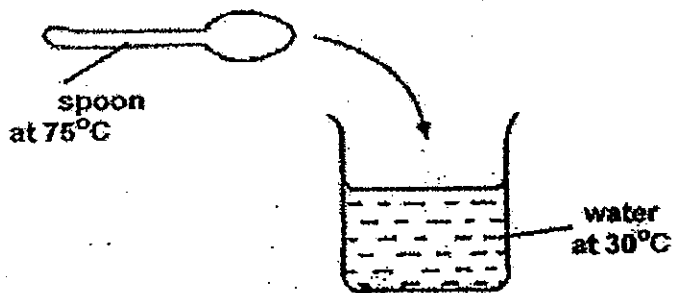

- 1) A only
- 2) A and B only
- 3) B and C only
- 4) A, B and D only

5. The data below shows the temperature of tap water in a flask as it was heated for 20 minutes.

Time (mins)	0	4	8	12	16	20
Temperature of water($^{\circ}\text{C}$)	20	40	60	80	100	?

Which of the following is most likely to be the temperature of the water after 20 minutes?

- 1) 80°C
- 2) 100°C
- 3) 120°C
- 4) 140°C

6. Which of the following factors affect the size and shape of shadows?

- A: The size of the screen.
- B: The position of the light source.
- C: The brightness of the light from the torchlight.
- D: The distance between the light source and the object.

- 1) A and C only
- 2) B and D only
- 3) A, B and C only
- 4) B, C and D only

7. Charmaine carried out an experiment to find out whether copper or steel conducts heat better. She filled some containers with hot water.

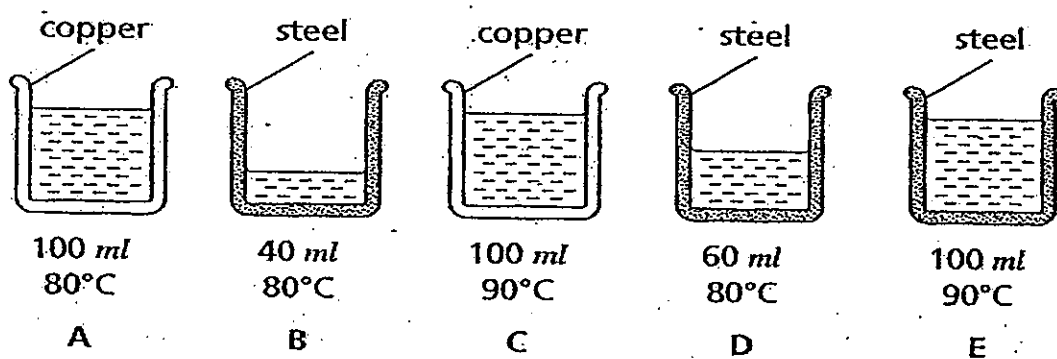

Which pair of the above set-ups should she use to conduct a fair test?

- 1) A and D only
- 2) B and D only
- 3) C and E only
- 4) A and E only

8. The diagram below shows a sharp bend along a narrow road known as Cherry Lane.

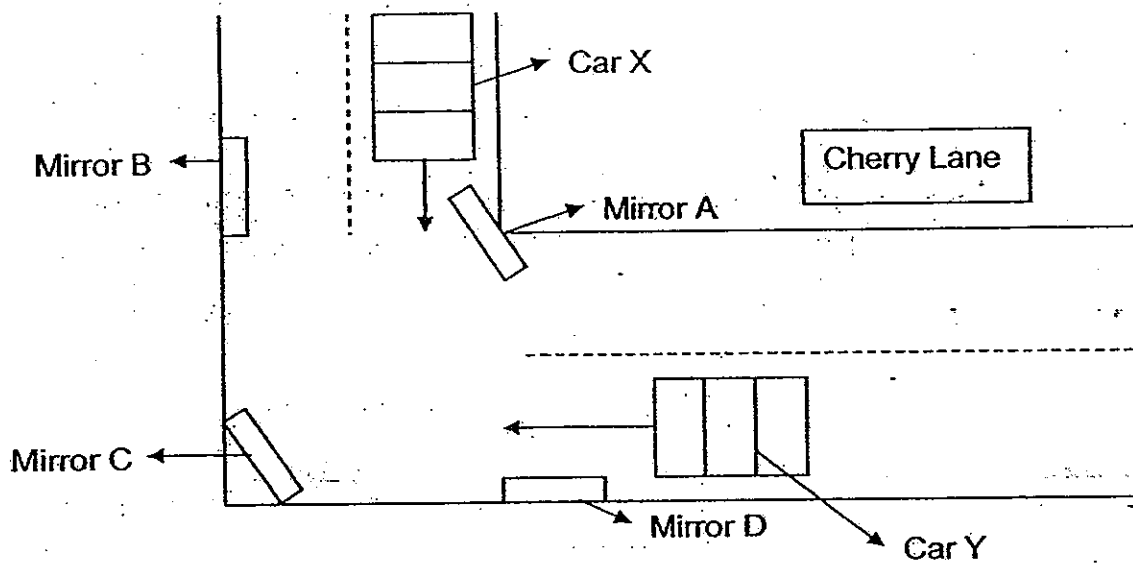

Where would you place a mirror so as to avoid an accident between two on-coming cars, X and Y?

- 1) Position A
- 2) Position B
- 3) Position C
- 4) Position D

9. Styrofoam boxes are used to pack food because _____.

- A: they are light and cheap
 B: they conduct heat to the food quickly
 C: when hot food is put in these boxes, the food will lose heat more slowly
 D: when cold food is put in these boxes, heat from outside will take a longer time to get in

- 1) A, B and C only
- 2) A, C and D only
- 3) B, C and D only
- 4) A, B and D only

10. Look at the diagrams below.

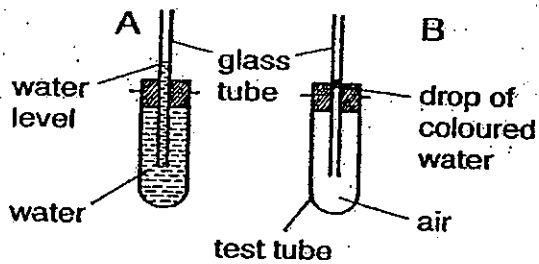

Diagram 1

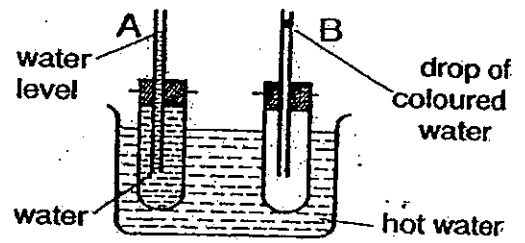

Diagram 2

Diagram 1 shows the set-ups of A and B.

Diagram 2 shows the same set-up of test tubes A and B placed in a basin of hot water.

Test tubes A and B were left in the basin of hot water for fifteen minutes. It was observed that the drop of coloured water in test tube B moved higher up than the water level in the glass tube of test tube A.

Which of the following statements is the best explanation for this observation?

- 1) Air is heavier than water.
- 2) Water cannot conduct heat.
- 3) Water has more energy than air when heated.
- 4) Air expands more quickly than water when heated.

11. A glass of boiling hot water was left in a room to cool. Which one of the following graphs best shows the temperature of the hot water over a period of time?

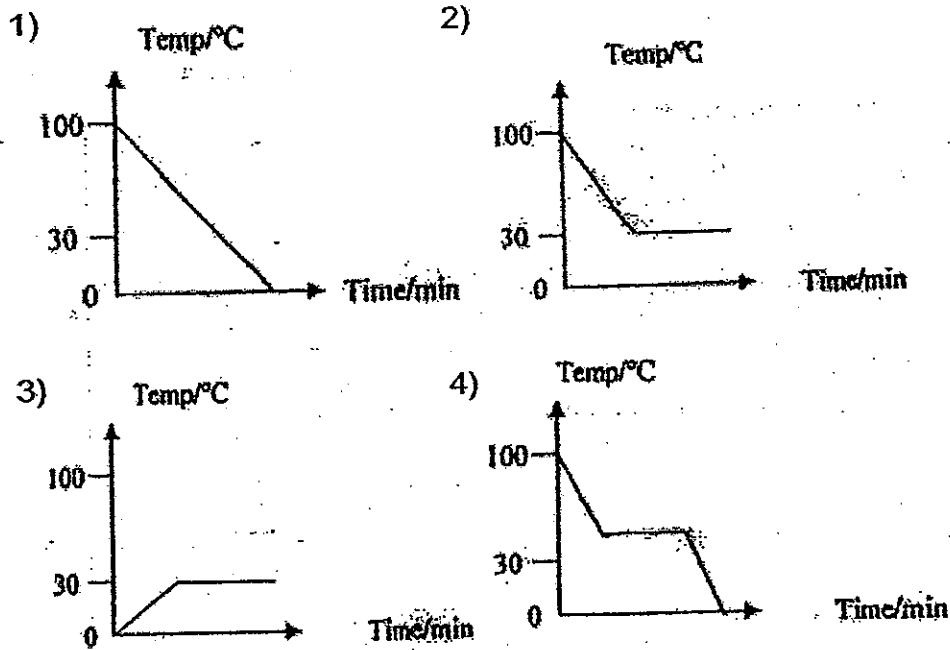

12. Willy's teacher gave him 3 containers as shown below. He was asked to conduct an experiment to find out which container can keep the water hottest after 10 minutes.



plastic container



styrofoam container

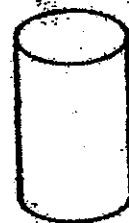

ceramic container

Which of the following apparatus is not needed for Willy to conduct the experiment?

- 1) Stopwatch
- 2) Glass container
- 3) Boiling water
- 4) Laboratory thermometer

13. A ruler is balanced on two bottles, each covered with a deflated balloon, as shown. Water at room temperature is added to the basin containing bottle A while boiling water is added to the basin containing bottle B. A flame burning continuously was also placed under the basin containing bottle B. Which one of the following would you expect to happen?

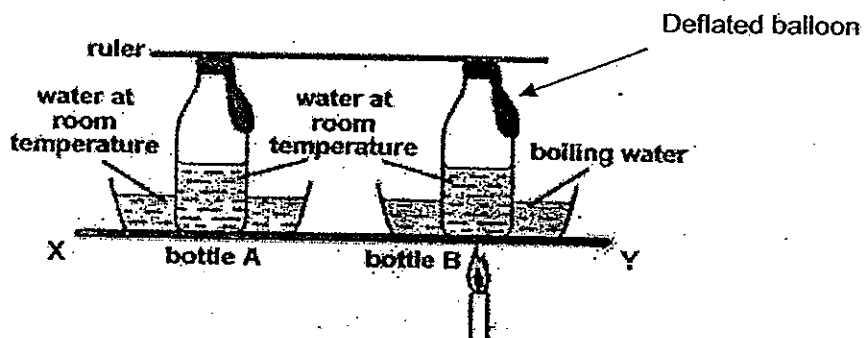

The ruler will _____.

- 1) remain balanced.
 - 2) break into two pieces.
 - 3) become unbalanced and slide towards Point X on the table.
 - 4) become unbalanced and slide towards Point Y on the table.
14. Why do people keep themselves warm by wearing woollen clothing in winter?
- A) Woollen clothing absorbs heat from the surroundings.
 - B) Woollen clothing does not allow heat to pass through them easily.
 - C) Woollen clothing does not insulate the body against the cold.
 - D) Woollen material traps air and this layer of air slows down the loss of body heat.
- 1) B only
 - 2) C only
 - 3) A and C only
 - 4) B and D only

15. A factory makes 8 types of materials. Each material is given a special code. The materials are classified in the table below.

Does not allow light to pass through	Allows light to pass through
A B C D	E F G H

A designer chose 4 materials from this table to build a wall inside a playroom. He asked five children to stand behind the walls, as shown in the diagram below.

Which one of the following statements is true?

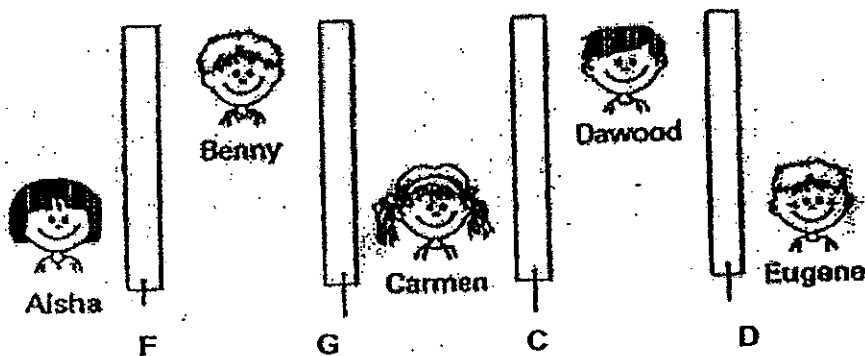

- 1) Carmen can see Aisha.
- 2) Aisha cannot see Benny.
- 3) Eugene can see Dawood.
- 4) Benny cannot see Carmen.

16. The flowchart below shows the properties of different materials, A, B, C and D:

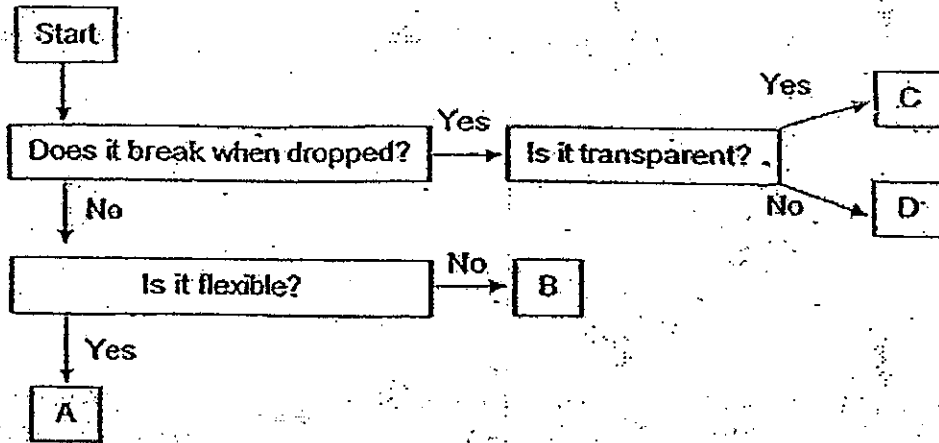

Which materials A, B, C or D are suitable for making the objects shown in the table below?

	A	B	C	D
1)	Cotton socks	Wine glass	Clay pot	Plastic spoon
2)	Plastic spoon	Clay pot	Cotton socks	Wine glass
3)	Cotton socks	Plastic spoon	Wine glass	Clay pot
4)	Clay pot	Wine glass	Plastic spoon	Cotton socks

17. Study the diagram below carefully.

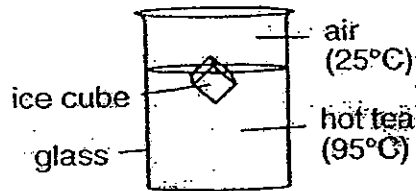

Which of the following statements are true?

- A) The ice cube will lose heat to the hot tea.
- B) The air will gain heat from the hot tea and ice cube.
- C) The temperature of the hot tea will be less than 95°C after 1 minute.
- D) The hot tea will lose heat to the ice cube, glass and the surrounding air.

- 1) A and B only
- 2) C and D only
- 3) B and C only
- 4) B and D only

18.

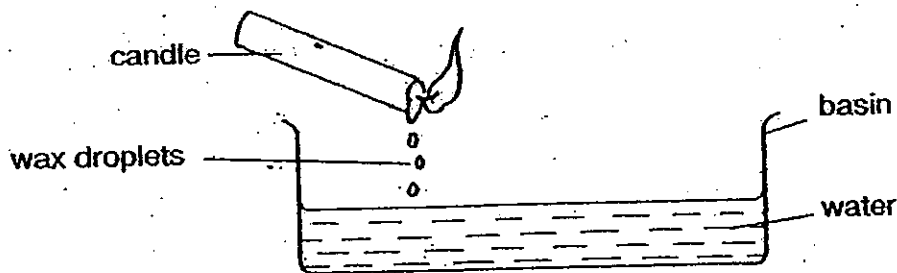

In the experiment above, which of the following will happen when wax droplets fall onto the water surface?

- A) The wax droplets solidify.
- B) The water level decreases.
- C) The wax droplets gain heat and the water loses heat.
- D) The wax droplets lose heat and the water gains heat.

- 1) A and B only
- 2) B and C only
- 3) A and D only
- 4) B, C and D only

19. Which of the following statement(s) about heat is/are FALSE?

- A) Most metals contract when heated.
- B) Heat can be produced when things burn.
- C) Our main source of heat is from electricity.
- D) Heat travels from a warm place to a cool place.

- 1) A only
- 2) C only
- 3) A and C only
- 4) B and D only

20. Study the table below carefully. Which one of the following is grouped correctly?

	Living Things	Non-Living Things	Once Alive
1)	Goat	Mirror	Plastic stool
2)	Duck	Plastic table	Straw hat
3)	Boulder	A ten-cent coin	Bamboo stick
4)	Glass	Leather shoes	Book

21. Clarice carried out an experiment to find out whether different amount of sunlight affect the rate at which plants photosynthesize. Which two set-ups below must she use to ensure a fair test?

Set-up	Type of plant	Amount of water	Location of plant
A	Balsam	40ml	Garden
B	String bean	40ml	Garden
C	String bean	40ml	Room
D	Balsam	70ml	Room

- 1) A and B
- 2) A and C
- 3) B and C
- 4) B and D

22. Jane conducted a scratch test on four different objects – W, X, Y and Z. She obtained the following results:

- A: X can scratch Y
- B: Z can scratch X.
- C: W can scratch Z.

Based on Jane's results, which conclusion is **INCORRECT**?

- 1) Y is the softest material.
- 2) Z is the hardest material.
- 3) Z is harder than X and Y.
- 4) X is harder than Y but softer than Z.

23. In an experiment, Animal X was placed in a tank with some water, leaves and flies. After 3 days, the amount of leaves and the number of flies left in the tank were recorded in the table below.

Day	Amount of Leaves	Number of Flies
1	70g	6
2	40g	6
3	10g	6

Animal X is most probably a/an _____.

- 1) frog
- 2) lizard
- 3) housefly
- 4) caterpillar

24. Mary placed two things, A and B, into two containers. She also placed the same type and amount of food in each jar. She then made some observations of A and B as shown below.

A	B
Moves around Feeds on the food given Grows bigger after 8 days	Does not move The food was not eaten at all No growth after 8 days

Which one of the following most possibly is A and B respectively?

	A	B
1)	Pebble	Ruler
2)	Cockroach	Twig
3)	Chick	Caterpillar
4)	Snail	Bird

25. Which set of the following statements shows the similarity and difference between the living things in the diagram below?



	Similarity	Difference
1)	Both A and B have roots.	A has leaves while B does not.
2)	Both A and B reproduce by seeds.	A contains chlorophyll while B does not.
3)	Both A and B reproduce by spores	A can make its own food while B cannot.
4)	Both A and B are living things.	A can respond to changes while B cannot.

26. Study the classification diagram below.

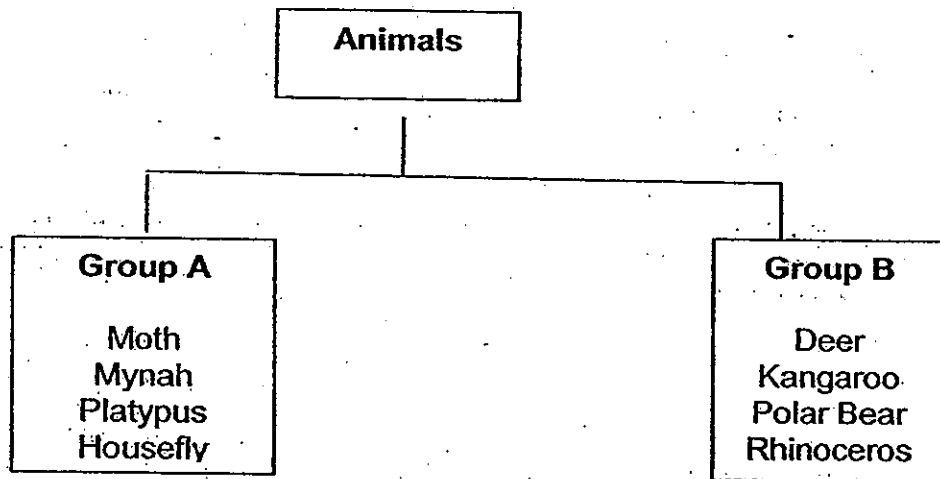

Which of the following are correct headings for Group A and Group B?

	Group A	Group B
1)	Insects	Mammals
2)	Herbivores	Carnivores
3)	Animals that lay eggs	Animals that give birth to live young
4)	Animals that live on land	Animals that live on land and in water

27. The properties of materials P and Q are listed in the table below.

Properties	P	Q
It can be stretched.	√	√
It is a natural product.	x	√
It allows light to pass through.	√	x
It can be made into many kinds of things.	√	√

Which of the following materials are P and Q likely to be?

	P	Q
1)	Plastic	Rubber
2)	Plastic	Wood
3)	Rubber	Plastic
4)	Wood	Plastic

28. The table below shows some of the things grouped according to the materials they are made of.

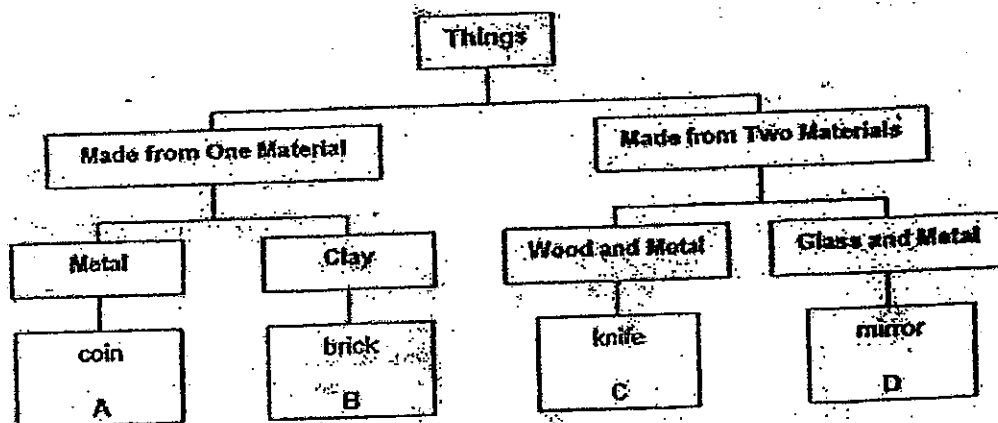

Which of the following best represents a nail and a light bulb?

	Nail	Light Bulb
1)	A	C
2)	A	D
3)	B	C
4)	B	D

29. Julie had two types of materials, X and Y, each of the same size. She wanted to find out which material would absorb the most amount of water. The table below shows the set-ups she had done.

Set-up	Material	Amount of water added to material
A	Y	100ml
B	X	50ml
C	Y	30ml
D	X	100ml

Which 2 set-ups should Julie choose in order for her test to be a fair test?

- 1) A and B
 - 2) A and C
 - 3) A and D
 - 4) B and C
30. A beaker containing 200ml of tap water was heated. After some time, an extra 100ml of tap water was added to the beaker. The beaker of water was left to boil. Which one of the following graphs describes the changes in temperature for the whole process?

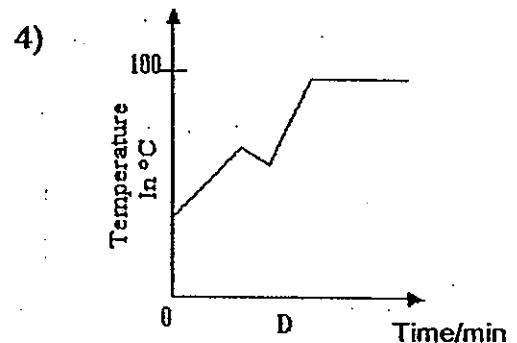
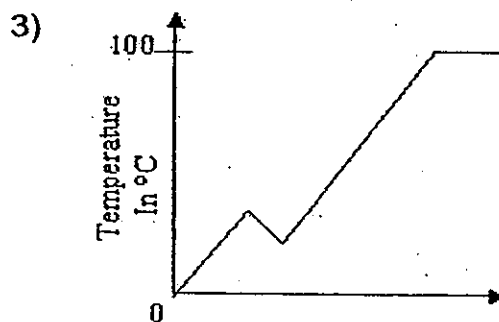
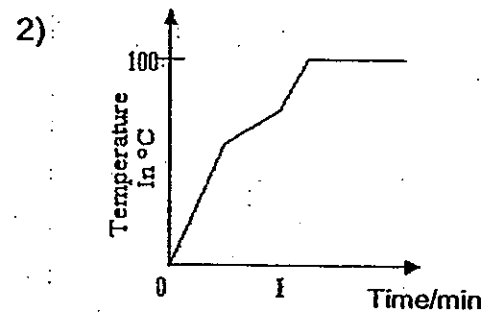
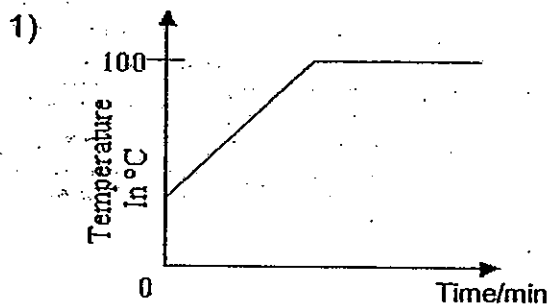



NAN HUA PRIMARY SCHOOL
SEMESTRAL ASSESSMENT 1 – 2010
PRIMARY 4

SCIENCE

BOOKLET B

14 Open-ended questions (40 marks)

Total Time for Booklets A and B : 1 hour 45 minutes

INSTRUCTIONS TO CANDIDATES

1. Write your name and index number in the space provided.
2. Do not turn over the page until you are told to do so.
3. Follow all instructions carefully.
4. Answer all questions.
5. Write your answers in this booklet.

Marks Obtained

Section B

	/40
--	-----

Name: _____ () Class: P 4 _____

Date : 12 May 2010

Parent's Signature: _____

Section B: (40marks)

Write your answers to question 31 to 44

The number of marks available is shown in brackets [] at the end of each question or part question.

31. What does object X produce when it is turned on?

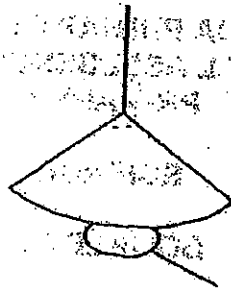

Object X

What does object X produce when it is turned on?

- a) _____
- b) _____

[2]

Score	2
-------	---

32. Three types of plants were placed into 3 identical containers filled with 200ml of water. A layer of oil was poured into each container to prevent the water loss through evaporation into the air.

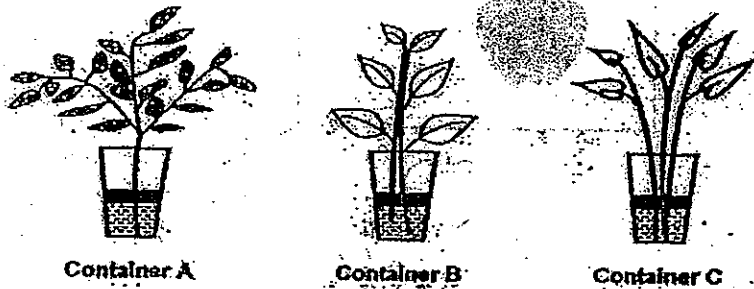

The volume of water in each container was recorded on the 7th day in the table below.

Container	Day 1: Volume of water (ml)	Day 7: Volume of water (ml)
A	200	180
B	200	175
C	200	200

a) Which of the containers (A, B or C) contained a plastic plant?

Container _____ [1]

b) Explain why there was less water in Containers A and B on Day 7. [1]

c) Suggest 2 other conditions needed by the plant to grow well. [1]

Score	3
-------	---

33. Study the diagram below. A light source is shone onto an apple and a shadow is formed on a smooth wall. However, the shadow formed is not clear.

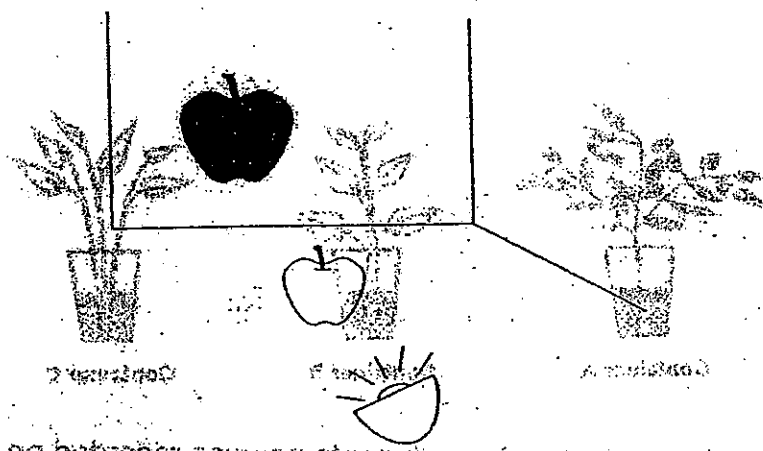

a) Give a possible explanation why the shadow is not clear. [1]

(1) 10/10

b) How can a sharper shadow be formed? [1]

34. Write down the materials that these objects are made of. [4]

	OBJECTS	MATERIALS
(1)	Key	
(2)	Towel	
(3)	Balloon	
(4)	Magazines	

Score	6
-------	---

35 Look at the diagram below
 Two beakers of water, A and B were heated at different times using different burners.

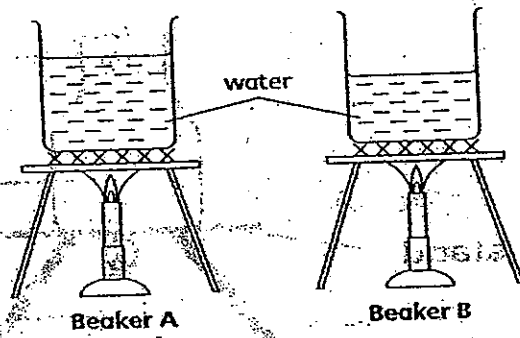

The graph below shows the changes in the temperature of the water in beakers A and B.

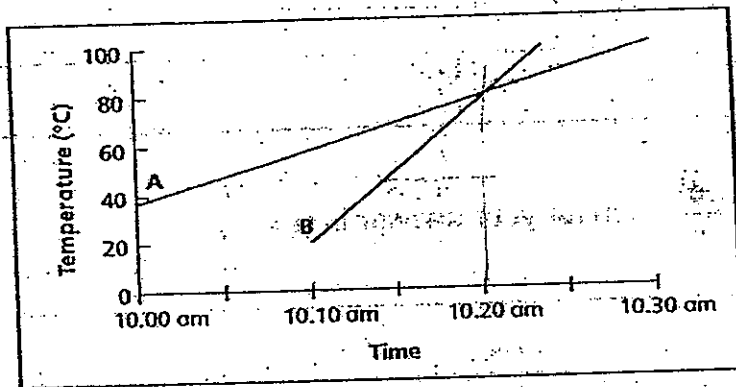

a) At what time did the two beakers of water reach the same temperature? [1]

b) Give one reason why the water in beaker A boiled after the water in beaker B. [1]

Score	2
-------	---

36. Natalie put a stopper onto an empty bottle as shown below. She then heated the bottle.

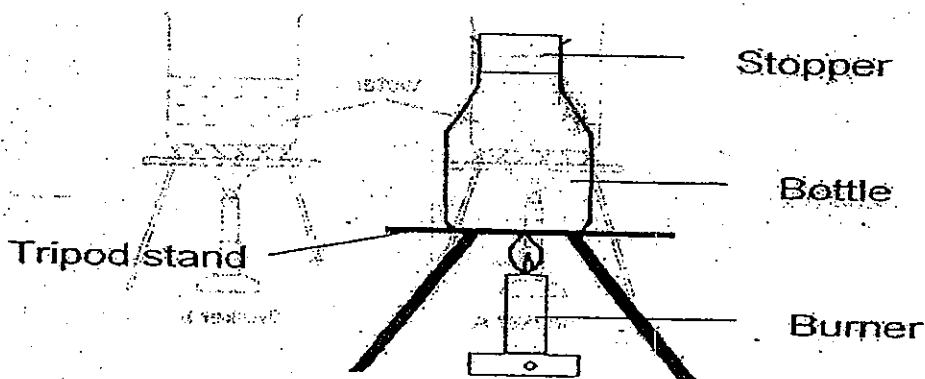

a) What will happen to the stopper when the bottle was heated? [1]

b) Give a reason for your answer in (a). [2]

Score	3
-------	---

37. Mary put an empty basin on the table in front of her class. She poured some water which had a temperature of 40°C into the basin. Then she dropped a few ice cubes into the basin of water.

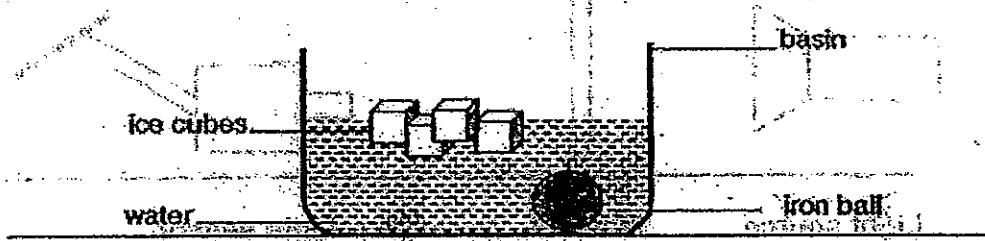

a) What would happen to the temperature of the water after the ice cubes were added? [1]

b) After about 5 minutes, she put an iron ball that was heated to 60°C into the basin of water.

Throughout the whole experiment, the various apparatus and substances had either gained or lost heat. Study the table below and tick the appropriate box to indicate whether heat was gained or lost by them. [4]

	Apparatus/ Substances	Heat gain	Heat loss
(1)	Basin (after the water was poured in)		
(2)	Ice cubes (after they were put into the basin of water)		
(3)	Water (after the iron ball was put into the basin)		
(4)	Iron ball (after it was put into the basin of water)		

Score	5
-------	---

38. Christopher tested four different materials E, F, G and H for the amount of light that can pass through the materials. He used a light sensor as shown below.

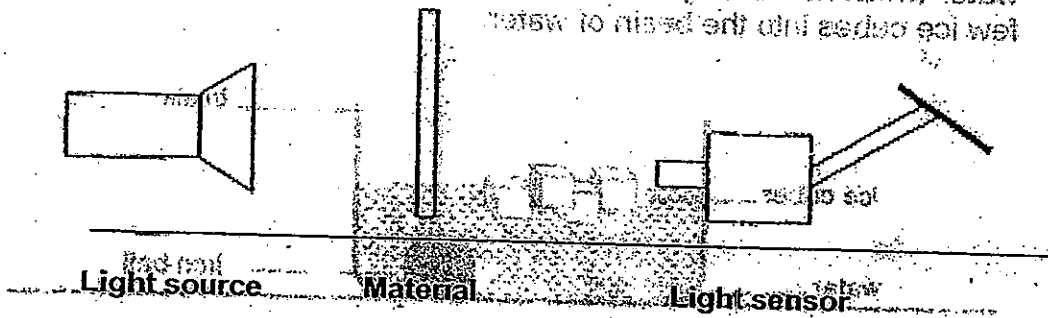

The table below shows the results he recorded after the test.

Materials	Amount of light (lux)
E	356
F	1256
G	0
H	815

a) Which of the above materials is the most suitable for making a fish tank?

[1]

b) Explain your choice in part (a).

[2]

Score	3
-------	---

39.

A little wax was melted on the handles of 2 spoons. The wax was allowed to cool and harden on the handles. Spoon A was made of porcelain while Spoon B was made of metal. Both spoons were placed in a beaker of hot water. After some time, the wax on both spoons melted.

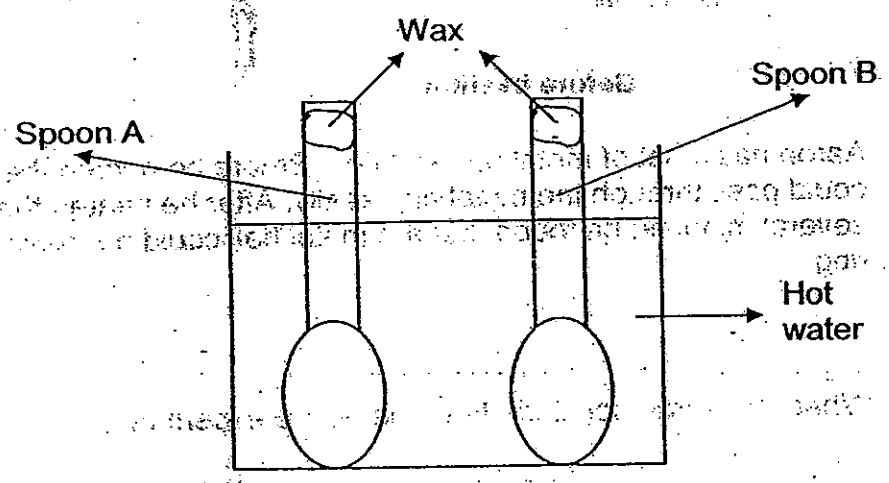

a) What is the aim of the experiment? [1]

b) On which spoon would the wax melt first? [1]

c) Name one variable that you should keep the same. [1]

Score	3
-------	---

40. Look at the diagram below carefully.

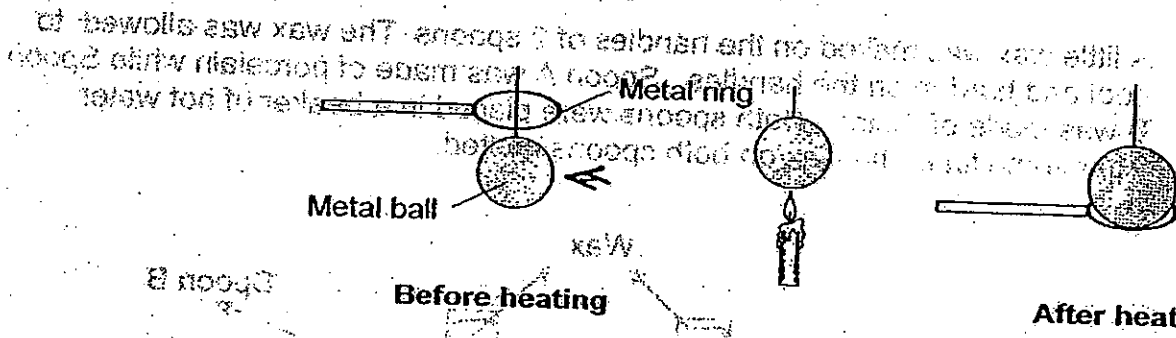

Aaron has a set of metal ball and ring. Before he heated the metal ball, the ball could pass through the metal ring easily. After he heated the metal ball for several minutes, he found that the metal ball could not pass through the metal ring.

a) What can Aaron conclude from the above experiment? [1]

b) What can Aaron do to the metal ball so that it can pass through the metal ring again, as quickly as possible? [1]

c) Explain your answer for (b). [1]

Score	3
-------	---

41. Mildred boiled some water in a kettle on a stove as shown in the diagram below.
When the water had reached boiling point, Mildred measured its temperature with a thermometer.

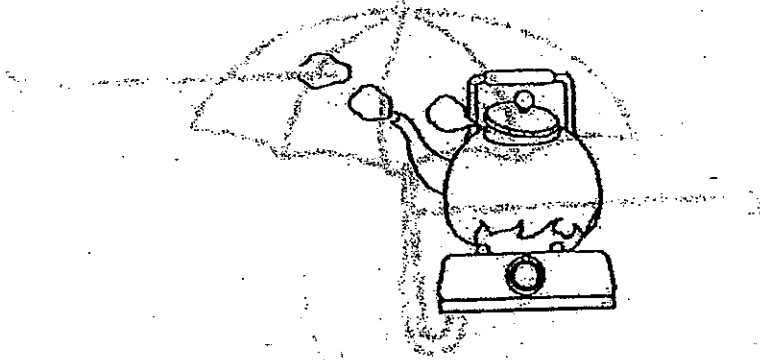

- a) What is the source of heat in the diagram? [1]

- b) What material was used for the kettle? [1]

- c) Why was the material in (b) used? [1]

- d) Suggest a material that Mildred could use to keep the boiled water hot for the next 30 minutes. [1]

Score	4
-------	---

42. The diagram shows an umbrella.

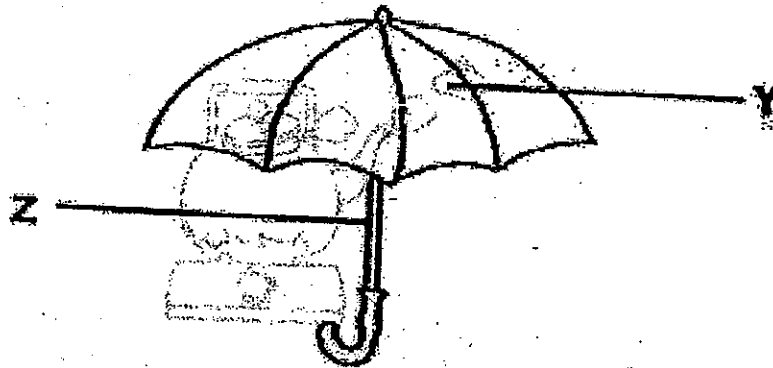

a) What is the one most important property that a material must have to make it suitable for making part Y of the above umbrella? [1]

b) Aluminium is usually used to make part Z. Why is aluminium a better choice than iron? [1]

Score	2
-------	---

43. The diagram below shows the shadows of a tree, cast at different times of the day. Fill in the blanks with the most appropriate time given in the box below.

8.00 am	10.00am	2.30pm	6.00pm
---------	---------	--------	--------

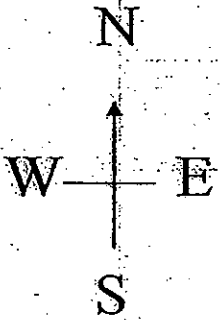

<p>(a) Time: _____</p>	<p>(b) Time: _____</p>
<p>(c) Time: _____</p>	<p>(d) Time: _____</p>

Score	2
-------	---

44. Brenda carried out an experiment with four rods, A, B, C and D, each made of a different material. All the four rods were put into the freezer for 3 minutes. The temperature of the rods were taken and recorded as shown below.

Rod	Temperature ($^{\circ}\text{C}$)
A	17
B	8
C	3
D	11

- a) Which rod is the best conductor of heat?

[1]

- b) Arrange in sequence from the best insulator to the worst insulator.

[1]

Best insulator



Worst insulator



Score

2

End of Paper

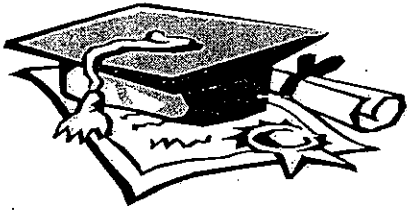

ANSWER SHEET

EXAM PAPER 2010

**SCHOOL : NAN HUA PRIMARY
SUBJECT : PRIMARY 4 SCIENCE**

TERM : SA1

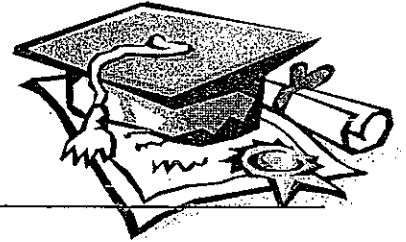

Q1	Q2	Q3	Q4	Q5	Q6	Q7	Q8	Q9	Q10	Q11	Q12	Q13	Q14	Q15	Q16	Q17
4	3	2	1	2	2	3	3	2	4	2	2	3	4	1	3	2

Q18	Q19	Q20	Q21	Q22	Q23	Q24	Q25	Q26	Q27	Q28	Q29	Q30
3	3	2	3	2	4	2	3	3	1	2	3	4

31)a)Light b)Heat

32)a)C

b)Container A and B plants absorb the water so there was less water on day seven.

c)They need sunlight and air.

33)a)The apple was far away from the wall and to close to the light source.

b)Put the apple nearer to the wall.

34)1)metal 2)cloth 3)rubber 4)paper

35)a)10.20 am

b)There was more water in Beaker A.

36)a)The stopper will shoot out of the bottle.

b)The air in the bottle got heated by the burner and expanded thus making the stopper shoot out of the bottle.

37)a)The temperature of the water will drop below 40°C.

b)1)Heat gain 2)Heat gain 3)Heat gain 4)Heat loss

38)a)Material F.

b)F allows the most light to pass through so that the fishes can be seen clearly.

39) a) The aim of the experiment is to find out which of the two spoons of the two spoons is a better conductor of heat.

b) Spoon B.

c) Where the wax is placed.

40) a) Things expand when they are heated.

b) Aaron should put the metal ball in to a bowl of cold water.

c) The metal ball will contract when it is cooled.

41) a) The source of heat is the stove.

b) Metal-steel.

c) Because metal is a good conductor of heat.

d) Styrofoam.

42) a) It must be waterproof.

b) Aluminium is lighter and cheaper than iron.

43) a) 2.30pm

b) 8.00am

c) 6.00pm

d) 10.00am

44) a) Rod C.

b) A → D → B → C