

Anglo-Chinese School (Junior)



SEMESTRAL ASSESSMENT 2 (2017)

**PRIMARY 4
MATHEMATICS**

Booklet A

Tuesday

31 October 2017

1 h 45 min

Name: _____ () Class: 4.()

INSTRUCTIONS TO PUPILS

- 1 Do not turn over the pages until you are told to do so.
- 2 Follow all instructions carefully.
- 3 There are 20 questions in this booklet.
- 4 Answer ALL questions.
- 5 Shade your answers in the Optical Answer Sheet (OAS) provided.

This question paper consists of 10 printed pages (inclusive of cover page).

Section A

Questions 1 to 20 carry 2 marks each.

For each question, four options are given. One of them is the correct answer. Make your choice (1, 2, 3 or 4). Shade the correct oval (1, 2, 3 or 4) on the Optical Answer Sheet (OAS). (40 marks)

1. The value of the digit 2 in 52 419 is _____.

- 1) 20
- 2) 200
- 3) 2000
- 4) 20 000

2. 31 658 rounded to the nearest hundred is _____.

- 1) 31 600
- 2) 31 660
- 3) 31 700
- 4) 32 000

3. $\frac{1}{4} + \frac{1}{6} =$ _____

- 1) $\frac{1}{24}$
- 2) $\frac{2}{4}$
- 3) $\frac{2}{10}$
- 4) $\frac{5}{12}$

4. $10.85 \times 7 =$ _____

- 1) 75.95
- 2) 70.85
- 3) 70.55
- 4) 17.85

5. The figure shown is made up of identical triangles. What fraction of the figure is shaded?

- 1) $\frac{5}{4}$
- 2) $\frac{5}{8}$
- 3) $\frac{4}{9}$
- 4) $\frac{5}{9}$

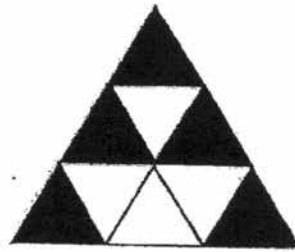

6. Figure ABCDEF is drawn on the square grid shown below. Which one of the following statements is true?

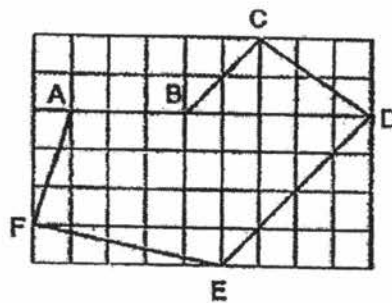

- 1) AB is parallel to FE.
- 2) BC is parallel to ED.
- 3) AF is perpendicular to FE.
- 4) CD is perpendicular to ED.

7. Mr Lim has 6892 stamps. He wants to pack all the stamps equally into 8 packets. How many stamps are left unpacked?

- 1) 5
- 2) 2
- 3) 3
- 4) 4

8. Look at the figures below. Which figure does not have any lines of symmetry?

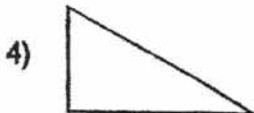
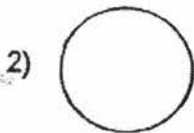

9. The bar graph shows the amount of money Jay save from July to December.

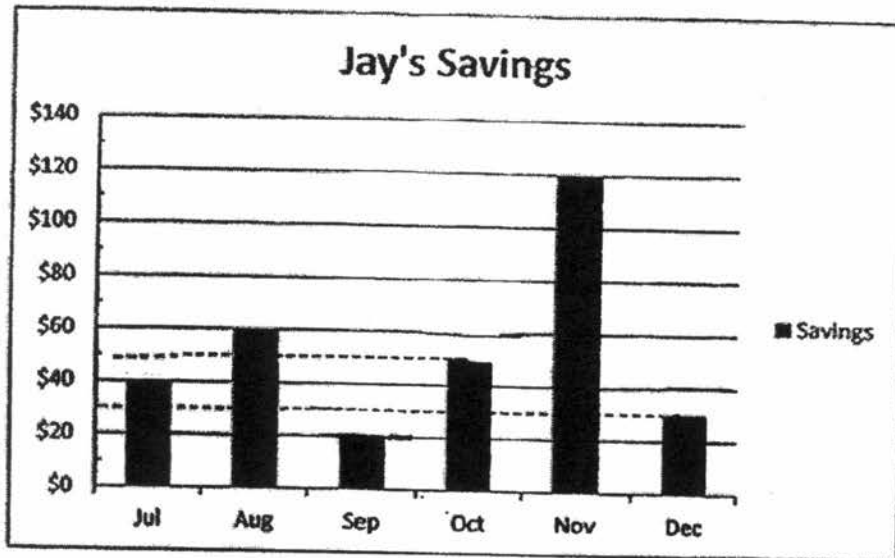

In which month, did Jay save half the amount he saved in August?

- 1) July
 - 2) September
 - 3) November
 - 4) December
10. What is the difference between the values of the digits 2 and 8 in the number 78.42?

- 1) 6
- 2) 7.98
- 3) 79.8
- 4) 79.98

11. $130 + \frac{7}{100}$ is the same as _____.

- 1) 13 ones and 7 tenths
- 2) 13 tens and 7 hundredths
- 3) 13 ones and 7 thousandths
- 4) 13 tens and 7 tenths

12. Jack started work at 1300 and Aryan started work 20 minutes later. Aryan took 2 hours and 35 minutes to complete his work. At what time did Aryan complete his work?

- 1) 15 50
- 2) 15 55
- 3) 16 10
- 4) 16 20

13. May drank $\frac{1}{4}$ litres of orange juice. Nancy drank $\frac{1}{5}$ litres of orange juice more than May. How much orange juice did May and Nancy drink altogether?

- 1) $\frac{3}{10}$
- 2) $\frac{7}{10}$
- 3) $\frac{1}{20}$
- 4) $\frac{9}{20}$

14. The two rectangles below have the same area, what is the length of rectangle B?

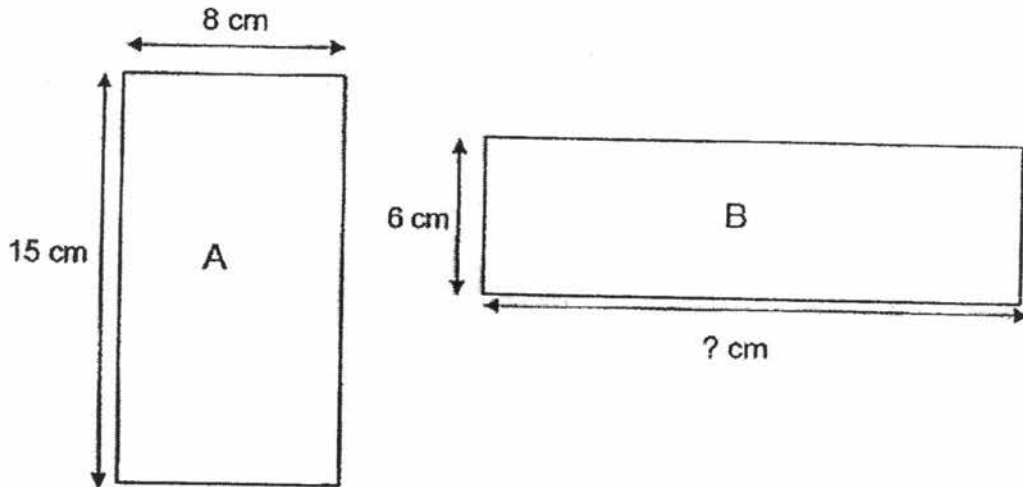

- 1) 8 cm
2) 17 cm
3) 20 cm
4) 56 cm
15. Henry made 108 paper aeroplanes in two days. He made 12 more paper aeroplanes on the second day than the first day. How many paper aeroplanes did he make on the first day?
- 1) 48
2) 54
3) 60
4) 96

16. The figure is made up of 2 rectangles, PQTU and QRST. $\angle PTQ = 28^\circ$ and $\angle QTM$ is two times $\angle PTQ$. Find $\angle MTS$.

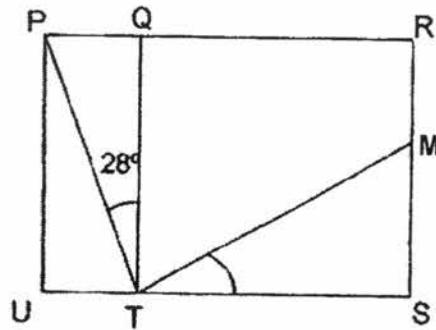

- 1) 14°
 - 2) 34°
 - 3) 56°
 - 4) 62°
17. Julian spent $\frac{2}{5}$ of his money on a book. He then had \$72 left. How much money did he have at first?
- 1) \$108
 - 2) \$120
 - 3) \$180
 - 4) \$360

18. The table below shows the number of books borrowed by some pupils in a school.

Number of books borrowed	0	1	2	3
Number of pupils	36	30	25	11

How many books did the pupils borrow altogether?

- 1) 66
 - 2) 102
 - 3) 113
 - 4) 149
19. The figure below is made up of four identical squares. The length of each of side of the square is 3 cm. What is the perimeter of the figure?

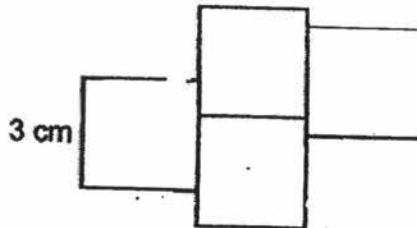

- 1) 30 cm
- 2) 36 cm
- 3) 38 cm
- 4) 48 cm

20. A wallet costs 3 times as much as a shirt. A wallet and 4 shirts cost \$420. How much does a shirt cost?

- 1) \$35
- 2) \$60
- 3) \$84
- 4) \$105

End of Booklet A

Anglo-Chinese School (Junior)



SEMESTRAL ASSESSMENT 2 (2017)

PRIMARY 4
MATHEMATICS

Booklet B

Tuesday

31 October 2017

1 h 45 min

Name: _____ () Class: 4.() Parent's Signature: _____

INSTRUCTIONS TO PUPILS

- 1 Do not turn over the pages until you are told to do so.
- 2 Follow all instructions carefully.
- 3 There are 25 questions in this booklet.
- 4 Answer ALL questions.

Section	Possible Marks	Marks Obtained
A	40	
B	40	
C	20	
Total	100	

This question paper consists of 14 printed pages (inclusive of cover page).

Section B

Questions 21 to 40 carry 2 marks each. Show your working clearly and write your answers in the boxes provided. For questions which require units, give your answers in the units stated. (40 marks)

21. Write Six thousand and twelve in figures.

22. Which two fractions below are in the simplest form?

$$\frac{2}{3}, \frac{3}{9}, \frac{4}{6}, \frac{7}{8}$$

_____ and _____

23. Arrange the following numbers in order from the smallest to the greatest.

0.682, 7.3, 0.703, 0.087

_____ , _____ , _____ , _____

(smallest) (greatest)

24. $8.26 - 5.48 =$ _____

25. Round 18.55 to the nearest whole number.

26. Write the missing number in the number pattern below.

3849 , 3799 , 3949 , _____ , 4249

27. What is the remainder when 1012 is divided by 8?

28. Which two of the fractions below are equivalent to $\frac{8}{12}$?

$$\frac{2}{3}, \frac{6}{8}, \frac{4}{6}, \frac{1}{2}$$

_____ and _____

29. In the figure shown, ABCD is a square. Find $\angle x$.

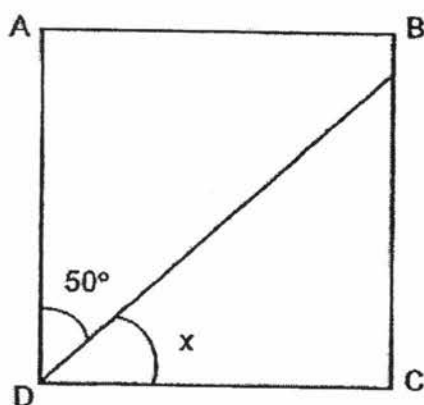

30. Mr. Lim took a flight from Singapore to Hong Kong at 17 45. He arrived in Hong Kong at 21 30. How long was the flight?

_____ h _____ min

31. The figure below is made up of squares. Shade two more squares so that the figure has a line of symmetry.

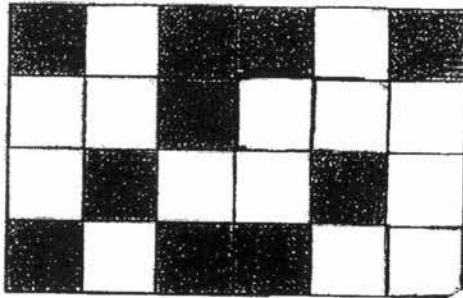

32. The figure below shows the seating plan of a classroom. Ben sits north of Albert and west of Dylan. Eve sits south-west of Faith.

In the plan below, write the name, Ben and Eve, in the two squares that each represent where they are sitting.

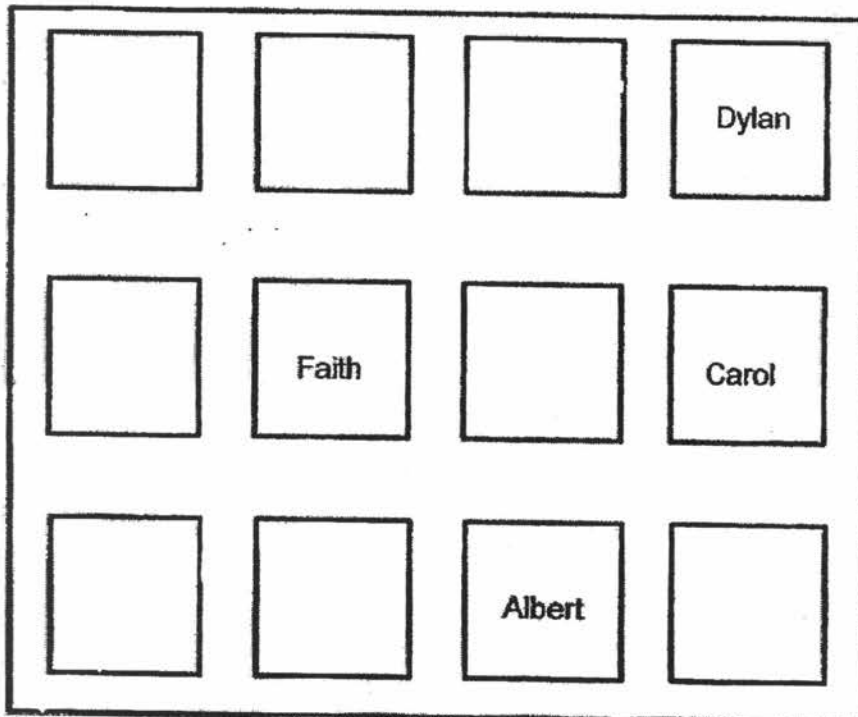

B5

Sub-Total :

33. The table below shows the number of pens sold at a school bookshop in a week. Each pen was sold at \$3.

Day	Monday	Tuesday	Wednesday	Thursday	Friday
Number of Pens Sold	25	10	15	5	5

Find the total amount of money collected from the sale of the pens from Monday to Thursday.

\$

34. Calvin had 80 cm of a wire. He used some wire to make a square. The length of each side of the square is 7 cm. What was the length of the wire left unused?

cm

B6

Sub-Total :

--

35. The figure below is made up of two rectangles. Find the perimeter of the figure.

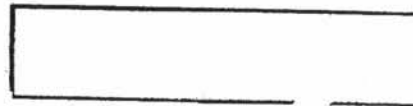
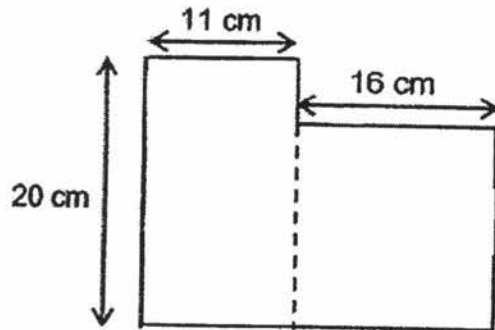

36. There are 84 blue and red beads in a box. $\frac{2}{7}$ of the beads are blue. How many more red beads than blue beads are there in the box?

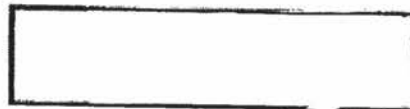

The line graph below shows the growth of a plant in terms of its height. The height of a plant was measured on every Tuesday for 7 weeks. Study the graph carefully and answer **Questions 37 and 38**.

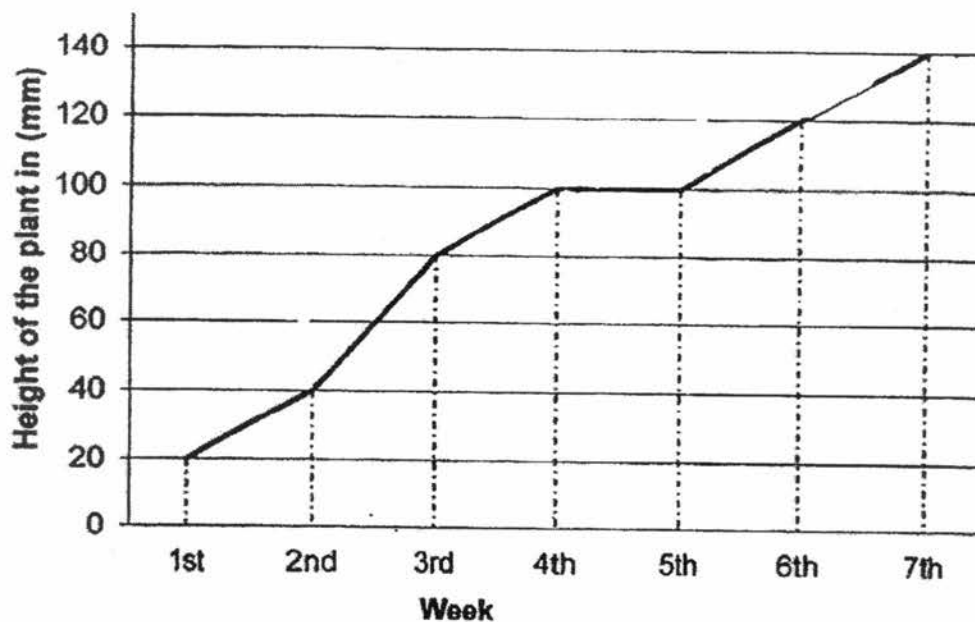

37. What was the growth of the plant between the 2nd week and the 5th week?

mm

38. During which period was the growth of the plant the most?

From _____ week to _____ week

□

39. The figure ABCD is made up of 3 identical rectangles. It has a perimeter of 180 cm. Find the length BC.

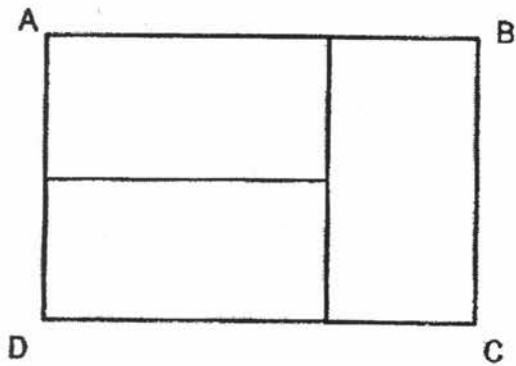

cm

40. The chairs in a hall were arranged in rows. Each row had the same of chairs. Jaydon sat on one of the chairs. There were 5 chairs to his right and 5 chairs to his left. There were 6 rows of chairs in front of him and 6 rows of chairs behind him. How many chairs were there in the hall?

B9

Sub-Total :

Section C

Questions 41 to 45 carry 4 marks each. For each question, show your working clearly as marks will be given for working and relevant statement. (20 marks)

41. At a shop, bags of sugar were sold at 2 for \$3.20. Each packet of sugar is 1.2 kg.

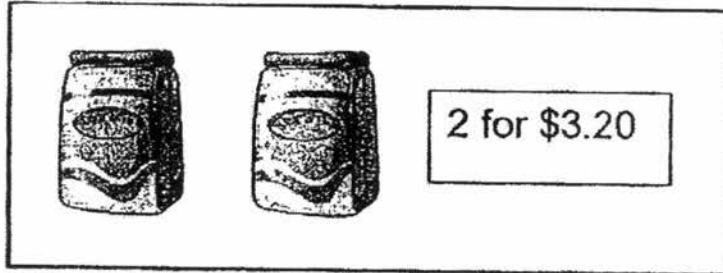

Mrs Heng bought 8 such bags.

- (a) What was the total mass of sugar Mrs Heng bought?
(b) How much did Mrs Heng pay?

Ans: a) _____ [2]

b) _____ [2]

B10

Sub-Total :

42. Harry had some money. He spent $\frac{1}{4}$ of his money on a number of muffins and $\frac{2}{3}$ of his money on some cakes.
- (a) What fraction of Harry's money was spent on muffins and cakes?
- (b) Harry had \$20 more on cakes than muffins. How much money did he have at first?

Ans: a) _____ [2]

b) _____ [2]

B11

Sub-Total :

43. The total mass of a basket and a watermelon is 4.65 kg. When some oranges are added into the basket, the total mass becomes 5.8 kg. The watermelon is 3 times as heavy as all the oranges.

(a) What is the mass of all the oranges?

(b) What is the mass of the basket? Give your answer in kilograms.

Ans: a) _____ [1]

b) _____ [3]

44. Alice, Beatrice and Candy had some beads. Alice and Beatrice had a total of 250 beads. Alice and Candy had 610 beads altogether. Given that Candy had 4 times as many beads as Beatrice, how many beads did Alice have?

Ans: _____ [4]

B13

Sub-Total :

45. Kenneth and Lucy had the same number of cookies at first. After Kenneth bought another 26 cookies and Lucy gave 43 cookies away, they have 279 cookies left. How many cookies did each of them have at first?

Ans: _____ [4]

End of Booklet B

B14

Sub-Total :

EXAM PAPER 2017 (P4)

SCHOOL : ACS

SUBJECT : MATHEMATICS

TERM : SA2

ORDER CALL :

Q1	Q2	Q3	Q4	Q5	Q6	Q7	Q8	Q9	Q10
3	3	4	1	4	2	4	4	4	2
Q11	Q12	Q13	Q14	Q15	Q16	Q17	Q18	Q19	Q20
2	2	2	3	1	2	2	3	1	2

21)6012 22) $\frac{2}{3}$ and $\frac{2}{8}$ 23)0.087 , 0.682 , 0.703 , 7.3

24)2.78 25)19 26)4099 27)4 28) $\frac{2}{3}$ and $\frac{4}{6}$

29) 40° 30)3 h 45 min 31)

32)

<input type="text"/>	<input type="text"/>	Ben	<input type="text"/>
<input type="text"/>	<input type="text"/>	<input type="text"/>	<input type="text"/>
Eve	<input type="text"/>	<input type="text"/>	<input type="text"/>

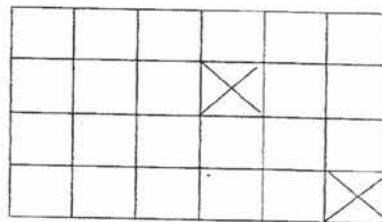

33)\$165 34)52cm 35)94cm 36)36red beans

37)60mm 38)2nd week/3rd week 39)36cm

40)143

41)a) $1.2 \times 8 = 9.6 \text{ kg}$

b) $3.20 \times 4 = \$12.80$

42)a) $\frac{1}{4} + \frac{2}{3} = \frac{11}{12}$

b) $20 \div 5 = 4$

$12 \times 4 = \$48$

43)a) $5.8 - 4.65 = 1.15 \text{ kg}$

b) $1.15 \times 3 = 3.45 = 1.2 \text{ kg}$

44) $360 \div 3 = 120$

$250 - 120 = 130$

45) $279 - 26 = 253$

$253 + 43 = 296$

$296 \div 2 = 148$