

Name: _____ ()

Class : Primary 4 _____

CHIJ ST NICHOLAS GIRLS' SCHOOL (PRIMARY)



Primary 4 Mathematics

2017 Semestral Assessment One

Booklet A

5 May 2017

TOTAL TIME FOR BOOKLETS A AND B: 1 HOUR 45 MINUTES

**Do not turn over this page until you are told to do so.
Follow all instructions carefully.
Answer all questions.**

This booklet consists of 10 printed pages including the cover page.

Section A: (20 x 2 marks)

For each question, four options are given. One of the options is the correct answer. Shade the correct oval (1, 2, 3 or 4) on the Optical Answer Sheet. Please use only 2B pencil and SHADE the oval completely.

1. In 49 673, the digit _____ is in the ten thousands place.
 - (1) 6
 - (2) 7
 - (3) 9
 - (4) 4

2. Round 37 552 to the nearest hundred.
 - (1) 38 000
 - (2) 37 600
 - (3) 37 550
 - (4) 37 500

3. Which of the following numbers are arranged from the smallest to the greatest?
 - (1) 3141, 3411, 3524, 3543
 - (2) 3212, 3221, 2331, 4321
 - (3) 3021, 3112, 3322, 3312
 - (4) 3451, 3315, 2341, 1532

4. Which of the following is NOT a common factor of 12 and 24?

(1) 12

(2) 8

(3) 3

(4) 6

5. What is the product of 36 and 25?

(1) 212

(2) 252

(3) 770

(4) 900

6. Look at the figure below. How many of the marked angles in the figure are greater than a right angle?

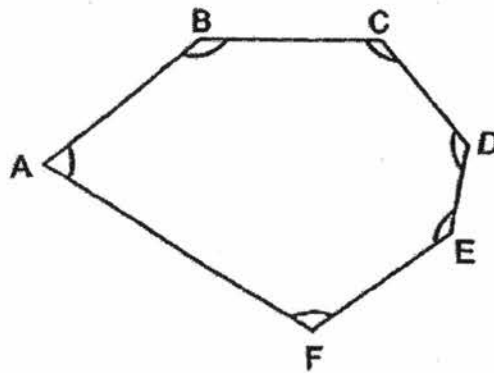

(1) 5

(2) 2

(3) 3

(4) 4

7. Lina was facing north-west at first. She turned in an anti-clockwise direction and faced north-east. What fraction of a complete turn did she make?

(1) $\frac{1}{2}$ -turn

(2) $\frac{1}{4}$ -turn

(3) $\frac{3}{4}$ -turn

(4) a complete turn

8. The rectangle ABCD is made up of 6 smaller identical squares. AD = 10 cm. What is the length of AB?

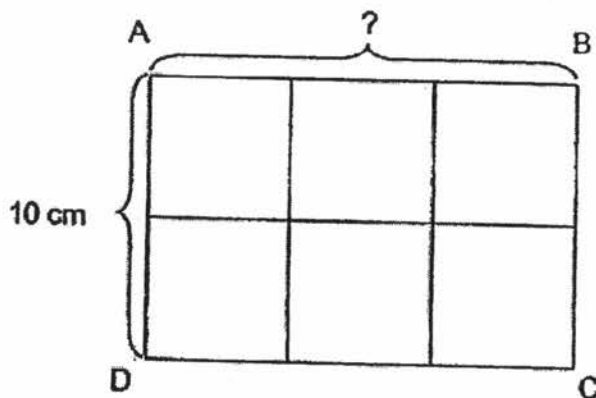

- (1) 5 cm
(2) 10 cm
(3) 15 cm
(4) 50 cm

9. Which line shows the correct line of symmetry?

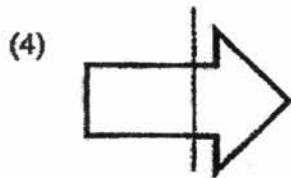
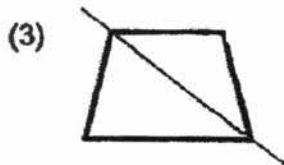
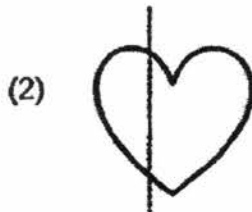

10. How many 4-digit numbers, which are greater than 4000, can be formed using the digits 8, 4, 3, 0? All of the digits should be used to form each 4-digit number.

- (1) 6
- (2) 2
- (3) 10
- (4) 12

11. A number when rounded to the nearest ten is 5000. What is the number?
- (1) 4994
 - (2) 4997
 - (3) 5005
 - (4) 5090
12. Divide 5432 by 4. The quotient is the sum of 2 numbers. One of the numbers is 849. What is the other number?
- (1) 509
 - (2) 519
 - (3) 1358
 - (4) 2207
13. Eliza bought 4 similar bags at \$492 at Shop A. Xiao Min bought 30 such bags from the same shop. How much did Xiao Min pay for the bags?
- (1) \$123
 - (2) \$369
 - (3) \$1968
 - (4) \$3690

14. A factory produced 2754 pens. It produced 200 more erasers than pens. It produced 500 fewer rulers than erasers. How many rulers did the factory produce?

- (1) 2454
- (2) 2554
- (3) 2954
- (4) 3454

15. Look at the protractor below.
Which angle shows 70° ?

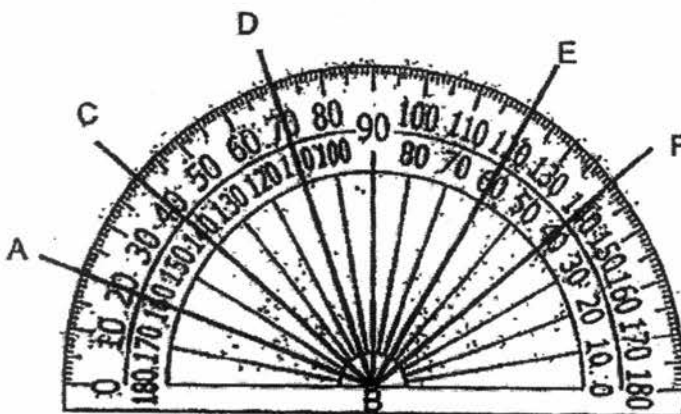

- (1) $\angle ABD$
- (2) $\angle CBE$
- (3) $\angle DBE$
- (4) $\angle DBF$

16. Geraldine was facing the hospital at first. She turned 225° anti-clockwise. Which place is she facing now?

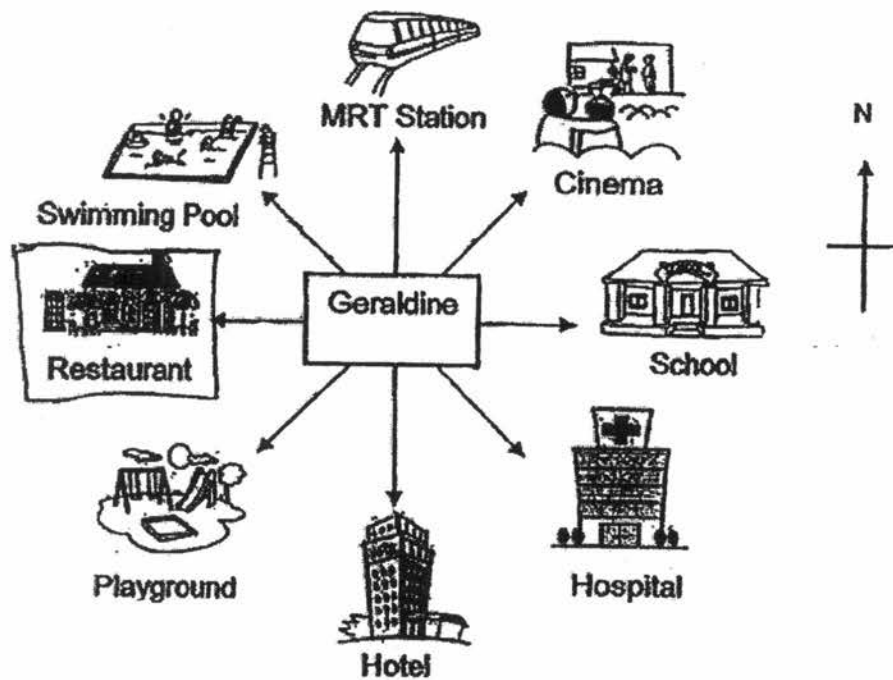

- (1) Cinema
- (2) Restaurant
- (3) MRT Station
- (4) Swimming Pool

17. The dotted line AB is the line of symmetry of the figure shown.
How many more squares must be shaded so that the figure is symmetric?

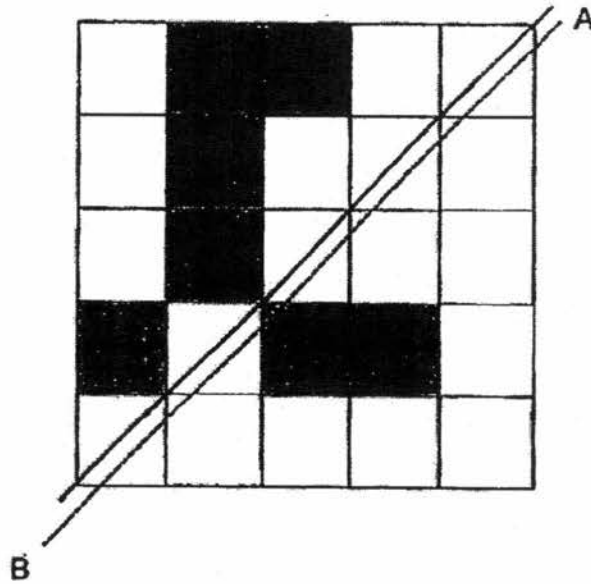

- (1) 1
(2) 2
(3) 3
(4) 4
18. I am a multiple of 9.
One of my factors is 7.
I am between 60 and 80.
What am I?

- (1) 63
(2) 70
(3) 72
(4) 77

19. Blue pens were sold in boxes of 12. Each box cost \$6. Jane spent \$48.
How many blue pens did she buy?

- (1) 96
- (2) 24
- (3) 8
- (4) 4

20. Shelly used sticks to form the figures that follow a pattern.
The first three figures are shown below.



Figure 1

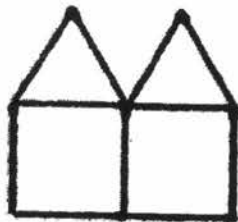

Figure 2

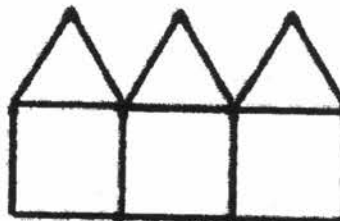

Figure 3

How many sticks are needed to make figure 5?

- (1) 18
- (2) 21
- (3) 26
- (4) 36

- END OF BOOKLET A -

Section B: (20 x 2 marks)

Do not
write in
this space

Write down your answers in the spaces provided. For questions which require units, give your answers in the units stated. Show all workings clearly.

21. What is 32 hundreds, 9 tens and 9 ones in figures?

Ans : _____

22. Look at the pattern below. What is the missing number?

7890, 17 890, 27 890, 37 890, _____, 57 890

Ans : _____

23. Some of the factors of 18 are 1, 2, 3 and 9. What are the other two factors?

Ans : _____ and _____



Do not
write in
this
space

24. $5024 + 8 =$ _____

Ans : _____

25. When a number is divided by 15, it gives a quotient of 483 and a remainder of 8. What is the number?

Ans : _____

26. Measure $\angle z$.

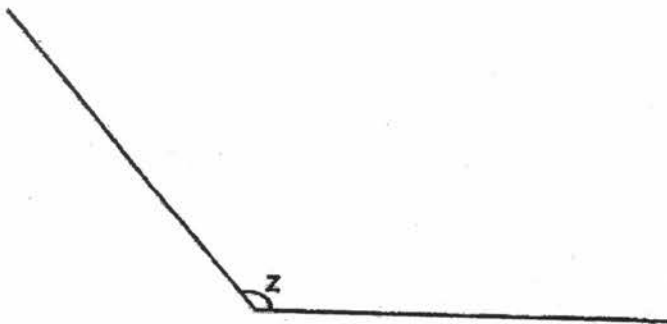

Ans : _____



27. Mary wrote down a 5-digit number on a piece of paper. However, she spilled some milk on it. Look at the clues given below.

Do not
write in
this
space

Clues:

- (i) The tens digit is 5 more than the ones digit.
- (ii) The hundreds digit is 3 less than the thousands digit.
- (iii) The ten thousands digit is three times of the ones digit.

What is the number?

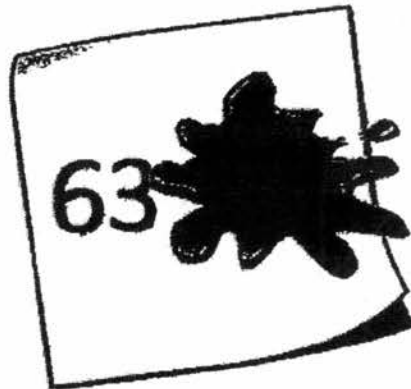

Ans : _____

28. Use the cards below to form the greatest 5-digit even number. Each digit should be used ONCE only.

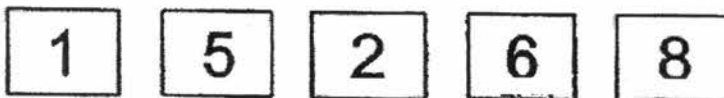

Ans : _____

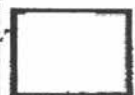

29. The difference between two numbers is 2400. The bigger number is five times the smaller number. Find the sum of the two numbers.

Do not
write in
this
space

Ans : _____

30. Denny has a carton of apples. There are fewer than 45 apples in the carton. The number of apples in the carton can be packed into bags of 3 or 5. What is the greatest possible number of apples in the carton?

Ans : _____

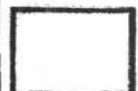

31. James hung 9 flags on a string at an equal distance apart shown below. What was the total length of string used?

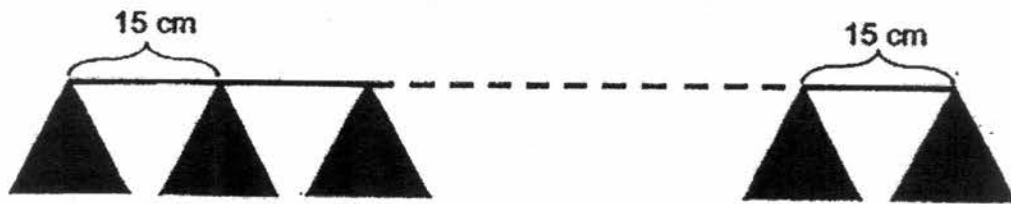

Do not
write in
this
space

Ans : _____ cm

32. Zachary and Sally picked 3250 strawberries altogether. Zachary picked 250 fewer strawberries than Sally. How many strawberries did Sally pick?

Ans : _____

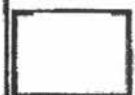

33. Tamara bought 13 boxes of stickers. There were 18 stickers in each box. She repacked all the stickers into packets of 4 stickers each. There were some stickers left that could not be packed into one packet. How many stickers were left unpacked?

Do not
write in
this
space

Ans : _____

34. For every 4 sets of newspapers Jason delivered, Mei Xin delivered 5 sets. They delivered 72 sets of newspapers in total. How many sets of newspapers did Jason deliver?

Ans : _____



35. A square piece of paper is folded as shown below. Find $\angle b$.

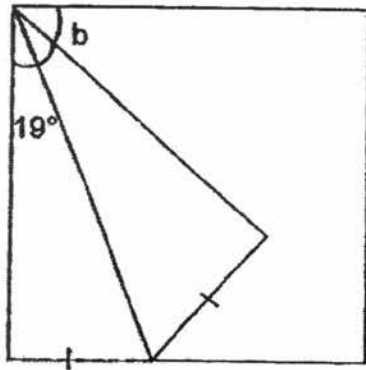

Do not
write in
this
space

Ans : _____ °

36. The figure below shows a square $WXYZ$ and a rectangle $EFGZ$. $ZE = EW$. ZE is twice as long as ZG . $ZG = 4$ cm. Find the length of WX .

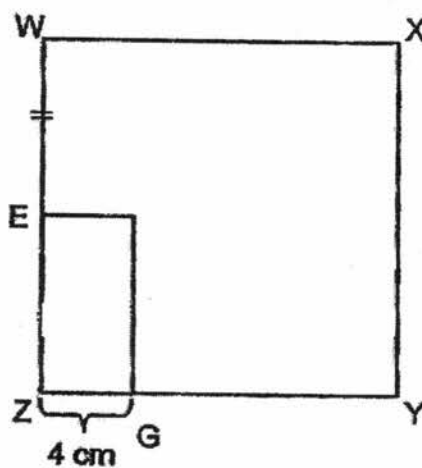

Ans : _____ cm



37. Which of these figures are symmetric?

Do not write in this space

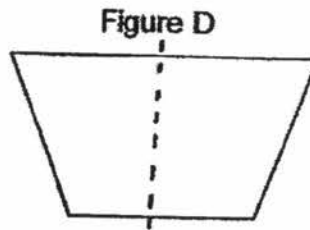
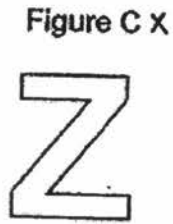
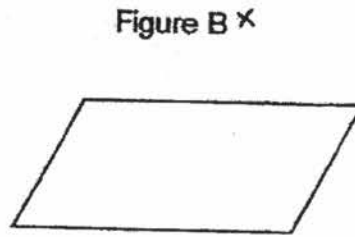
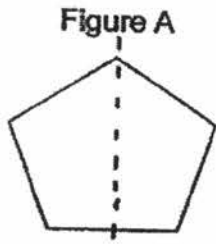

Ans : Figures _____ and _____

38. The figure below is made up of a square and a rectangle. Find $\angle c$.

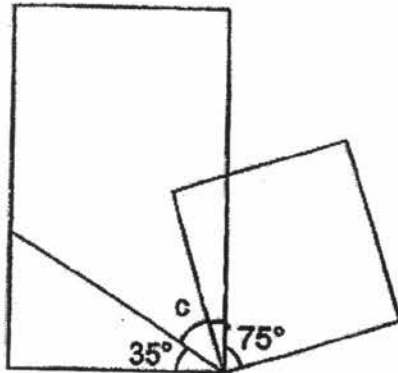

Ans : _____ °

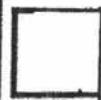

39. An aeroplane made 4 trips. It travelled 3075 km each on 2 of the trips. On the other trips, it travelled 1740 km each. What was the total distance travelled by the aeroplane?

Do not
write in
this
space

Ans : _____ km

40. Anita had 403 more stamps than Li Wei. Li Wei gave Anita another 268 stamps. How many more stamps did Anita have than Li Wei in the end?

Ans : _____

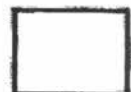

Section C: (22 marks)

Do not write in this space

Solve the following problems. All mathematical working and statements must be shown clearly.

41. PQRS is a rectangle. Find the sum of $\angle a$ and $\angle b$.

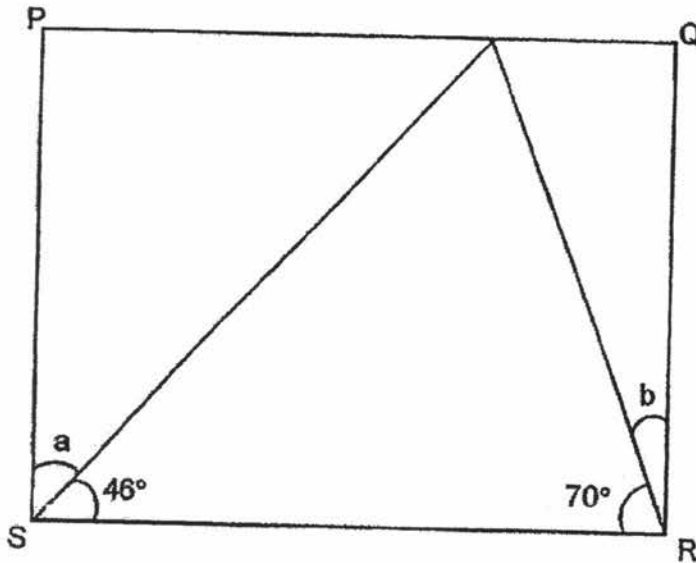

Ans : _____ [3]

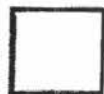

42. 7 similar magazines and 5 similar books cost \$105. Each book cost \$14.
How much did each magazine cost?

Do not
write in
this space

Ans : _____ [3]

43. 3 pillows and 4 bolsters cost \$184. Each bolster costs \$18 more than a pillow.
Find the cost of a pillow.

Do not
write in
this space

Ans : _____ [3]

44. Michelle wanted to buy 6 cans of food for her dog. She visited two shops which sold the same type of canned food.
- a) She wanted to save some money. Which shop should she buy from?
 - b) How much more money would she save from buying the 6 cans of food?

Do not
write in
this space



Shop A

1 can for \$4



Shop B

1 can for \$6

Ans : a) Shop _____ [1]

b) _____ [2]



45. There were an equal number of boys and girls in the Art club at first. Then, another 17 boys joined the club and another 7 girls left the club. There are four times as many boys as girls in the club now.

- a) How many girls were there at first?
- b) How many children were there at first?

Do not write in this space

Ans : a) _____ [3]

b) _____ [1]

46. Maisie and Wei Qiang saved a total of \$4586. Wei Qiang and Ali saved a total of \$1321. Maisie saved 6 times as much money as Ali. How much money did Wei Qiang save?

Do not
write in this
space

Ans : _____ [4]

****END OF PAPER****

SCHOOL : CHIJ ST NICOLAS PRIMARY SCHOOL
LEVEL : PRIMARY 4
SUBJECT : MATH
TERM : 2017 SA1

CONTACT :

SECTION A

Q 1	Q2	Q3	Q4	Q5	Q6	Q7	Q8	Q9	Q10
4	2	1	2	4	1	3	3	1	4

Q 11	Q12	Q13	Q14	Q15	Q 16	Q17	Q18	Q19	Q20
2	1	4	1	4	2	3	1	1	3

SECTION B

Q21	Q22	Q23	Q24	Q25
3299	47890	6,18	628	7251

Q26	Q27	Q28	Q29
132	63072	86512	3600

Q30)	<u>30</u>
Q31)	$15 \times 8 = \underline{120}$
Q32)	$3250 - 250 = 3000$ $3000 \div 2 = 1500$ $1500 + 250 = \underline{1750}$
Q33)	$13 \times 18 = 234$ $234 \div 4 = 58 \text{ R } 2$ (Ans : 2)

Q34)	$J + M = 4 + 5 = 9$ $72 \div 9 = 8$ (8 sets of 9) $J \rightarrow 4 \times 8 = \underline{32}$										
Q35)	$19 \times 2 = 38$ $90 - 38 = \underline{52}$										
Q36)	<u>16</u>										
Q37)	<u>A and D</u>										
Q38)	$90 - 75 = 15$ $90 - 15 - 35 = \underline{40}$										
Q39)	$3075 \times 2 = 6150$ $6150 + 1740 = 7890$ $7890 + 1740 = \underline{9630}$										
Q40)	<table style="margin-left: 20px;"> <tr> <td style="padding-right: 10px;">A</td> <td style="border: 1px solid black; width: 100px; height: 20px;"></td> <td style="border: 1px solid black; width: 50px; text-align: center;">268</td> <td style="border: 1px solid black; width: 50px; text-align: center;">403</td> <td style="border: 1px solid black; width: 50px; text-align: center;">268</td> </tr> <tr> <td>L</td> <td style="border: 1px solid black; width: 100px; height: 20px;"></td> <td style="border: 1px solid black; width: 50px; text-align: center;">268</td> <td colspan="2" style="border: none; text-align: center;">→</td> </tr> </table> $403 + 268 = 671$ $671 + 268 = \underline{939}$	A		268	403	268	L		268	→	
A		268	403	268							
L		268	→								
Q41)	$\text{Angle } a = 90 - 46 = 44$ $\text{Angle } b = 90 - 70 = 20$ $\text{Angle } a + \text{angle } b = 44 + 20 = \underline{64}$										
Q42)	$\$14 \times 5 = \70 $\$105 - \$70 = \$35$ $\$35 \div 7 = \underline{\$5}$										

Q43)

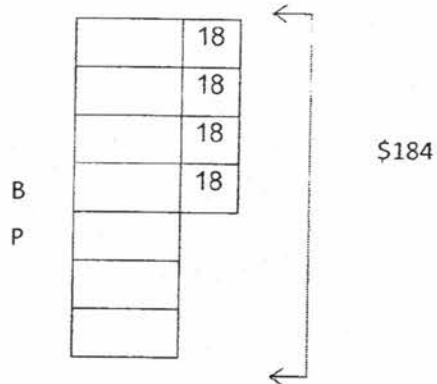

$$\$18 \times 4 = \$72$$

$$\$184 - \$72 = \$112$$

$$\$112 \div 7 = \underline{\$16}$$

Q44)

(a) She should buy from store B

(b) $4 \times 6 = 24$

$$6 \times 3 = 18$$

$$24 - 18 = 6$$

She would save \$6

Q45)

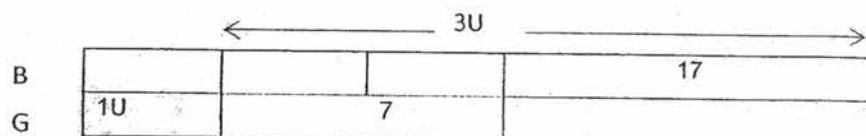

(a) $17 + 7 = 24$

$$24 \div 3 = 8$$

$$8 + 7 = \underline{15}$$

(b) $15 + 15 = \underline{30}$

Q46)

Maisie + WQ \rightarrow \$4586

Ali + WQ \rightarrow \$1321

Maisie + Ali \rightarrow \$4586 - \$1321 = \$3265

5 units \rightarrow \$3265

1 unit \rightarrow \$3265 \div 5 = \$653

\$1321 - \$653 = \$668