



# AI TONG SCHOOL

2010

SEMESTRAL ASSESSMENT 1

PRIMARY 4

MATHEMATICS

DURATION : 1 H 45 MIN

DATE: 11 May 2010

## INSTRUCTIONS

Do not open the booklet until you are told to do so.

Follow all instructions.

Answer all questions.

Name : \_\_\_\_\_ ( )

Class : Primary 4 \_\_\_\_\_

Marks:

Parent's Signature : \_\_\_\_\_

Date : \_\_\_\_\_

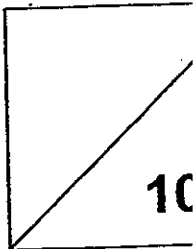

### **Section A**

Questions 1 to 14 carry 2 marks each. For each question, four options are given. One of them is the correct answer. Make your choice (1, 2, 3 or 4). Shade the oval (1, 2, 3 or 4) on the Optical Answer Sheet with a 2B pencil. (28 marks)

---

- 1 In 75 286, what is the value of the digit 2?
- (1) 20
  - (2) 200
  - (3) 2000
  - (4) 20 000
- 2 Which of the following numbers is 32 400 when rounded off to the nearest 100?
- (1) 32 451
  - (2) 32 449
  - (3) 32 345
  - (4) 32 349
- 3 Complete the number pattern.
- 46 200, 46 500, \_\_\_\_\_, 47 100
- (1) 46 600
  - (2) 46 700
  - (3) 46 800
  - (4) 46 900
- 4 6 is a common factor of \_\_\_\_\_.
- (1) 18 and 30
  - (2) 6 and 28
  - (3) 3 and 6
  - (4) 3 and 2

5 When a number is divided by 8, the answer is 864. What is this number?

- (1) 108
- (2) 856
- (3) 872
- (4) 6912

6 What is the product of 136 and 28 when rounded off to the nearest 10?

- (1) 3800
- (2) 3810
- (3) 27 200
- (4) 27 210

7 Susan fried 349 chicken drumsticks. She packed them into boxes of 7 chicken drumsticks. What was the minimum number of boxes she used if all the chicken drumsticks were packed into boxes?

- (1) 49
- (2) 50
- (3) 51
- (4) 56

8  $\frac{3}{8} + \frac{3}{8} + \frac{3}{8} + \frac{3}{8} =$

- (1)  $\frac{12}{32}$
- (2)  $1\frac{1}{3}$
- (3)  $1\frac{1}{2}$
- (4)  $4\frac{3}{8}$

9 Jason kept  $\frac{5}{8}$  of his money and gave the rest to his mother. If he had \$1200 at first, how much money did he give to his mother?

- (1) \$240
- (2) \$400
- (3) \$450
- (4) \$750

10 Mrs Lee bought 4 kg of flour. She used  $\frac{5}{12}$  of it to make cookies and  $\frac{2}{3}$  kg to make an apple pie. How much flour had she left?

- (1)  $2\frac{11}{12}$  kg
- (2)  $2\frac{2}{3}$  kg
- (3)  $1\frac{2}{3}$  kg
- (4)  $1\frac{1}{12}$  kg

11 How many more squares must be shaded so that  $\frac{5}{6}$  of the figure is shaded?

- (1) 10
- (2) 6
- (3) 5
- (4) 4

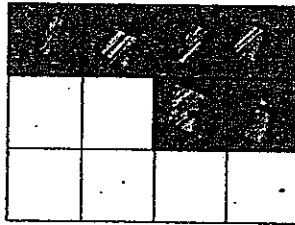

- 12 A square of side 8 cm has the same area as a rectangle. If the breadth of the rectangle is 4 cm, what is its length?

- (1) 2 cm
- (2) 12 cm
- (3) 16 cm
- (4) 32 cm

- 13 The figure is made up of two squares. What is the perimeter of the figure?

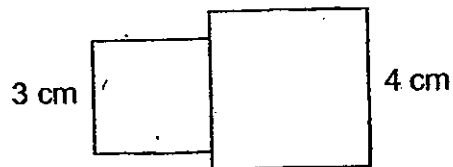

- (1) 21 cm
- (2) 22 cm
- (3) 25 cm
- (4) 28 cm

14

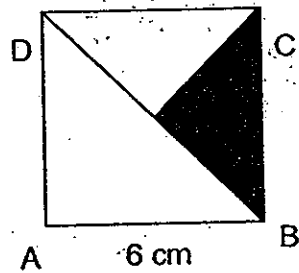

The figure above shows a square ABCD of side 6 cm. Find the area of the shaded part.

- (1)  $6 \text{ cm}^2$
- (2)  $9 \text{ cm}^2$
- (3)  $18 \text{ cm}^2$
- (4)  $36 \text{ cm}^2$

**Section B**

Questions 15 to 34 carry 2 marks each. Write your answers in the spaces provided. For questions which require units, give your answers in the units stated.

(40 marks)

---

15 Write forty-five thousand and sixty in figures.

Ans: \_\_\_\_\_

---

16 Find the value of  $4565 + 542$

Ans: \_\_\_\_\_

---

17 Find the sum of all the factors of 12?

Ans: \_\_\_\_\_

---

18 Form the smallest five-digit odd number using all the digits below.

7, 0, 4, 3, 1

Ans: \_\_\_\_\_

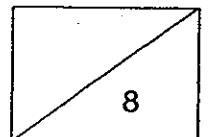

19 Express  $3\frac{4}{7}$  as an improper fraction.

Ans: \_\_\_\_\_

---

20  $1850 = \square \times 10$ . What is the missing number in the box?

Ans: \_\_\_\_\_

---

21 When a number is divided by 4, it has a quotient of 86 and a remainder of 3. What is the number?

Ans: \_\_\_\_\_

---

22 Express 26 sixths as a mixed number. Give your answer in its simplest form.

Ans: \_\_\_\_\_

---

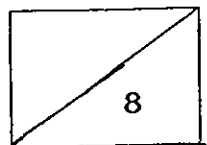

23 What is  $\frac{3}{5}$  of 40?

Ans: \_\_\_\_\_

24 Irvin goes to the library once every 4 days. Ryan also goes to the same library once every 5 days. If they first met on the 3<sup>rd</sup> May, which day would they meet again?

Ans: \_\_\_\_\_

25 There were 245 comic books on sale at a book fair. James sold  $\frac{3}{5}$  of the books and packed the remaining books into sets of 6. How many sets of comic books did he manage to pack?

Ans: \_\_\_\_\_

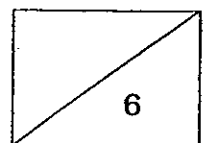



- 26 Alvin is standing in the middle of the 8-point compass facing South-west. Where will he be facing if he makes a  $\frac{1}{4}$ -turn clockwise?

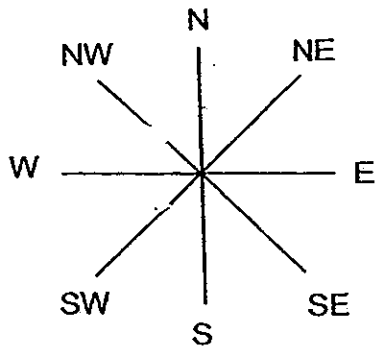

Ans: \_\_\_\_\_

- 27 Using a protractor, measure angle Z.

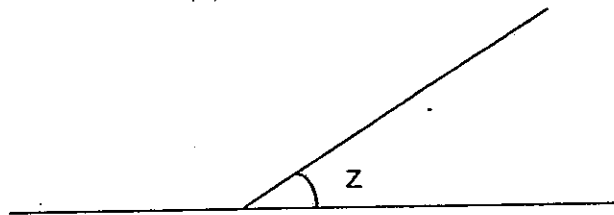

Ans: \_\_\_\_\_

- 28 How many pairs of parallel lines are there in the diagram shown below?

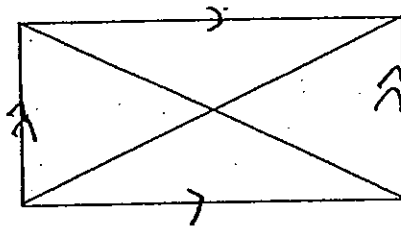

Ans: \_\_\_\_\_

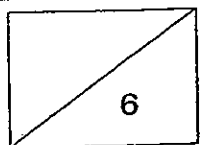

29 Draw a line perpendicular to AB through the point X.

• X



30 In the figure below, PQ is perpendicular to QR. Find angle SQR.

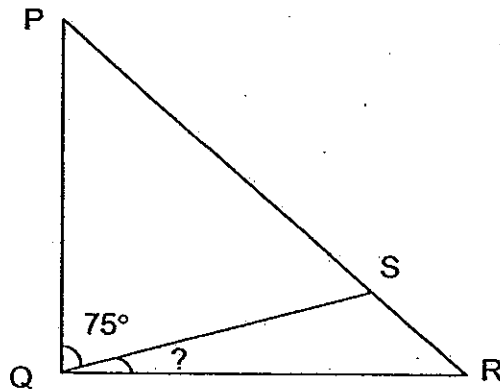

Ans: \_\_\_\_\_

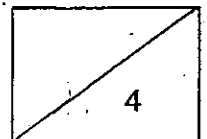

31

WXYZ is a rectangle not drawn to scale. Find angle  $f$ .

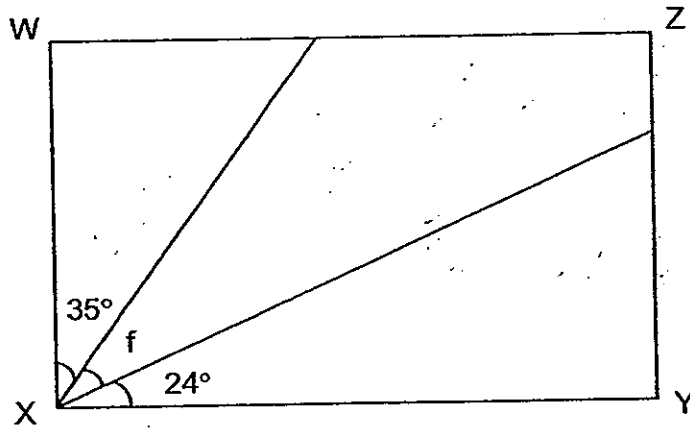

Ans: \_\_\_\_\_

32

PQRS is a square of side 12 cm. W, X, Y and Z are the mid-points of each side of the square PQRS. Find the area of WXYZ.

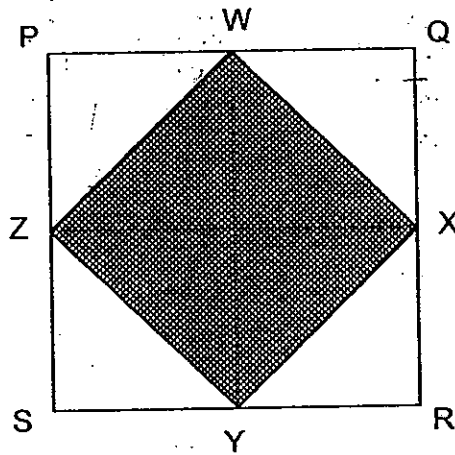

Ans: \_\_\_\_\_  $\text{cm}^2$

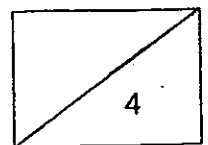

- 33 The figure below, not drawn to scale, is made up of 5 identical squares. The perimeter of the figure is 36 cm. What is the length of each side of the square?

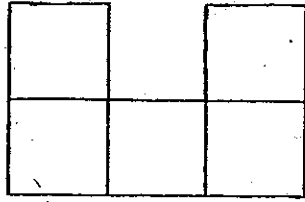

Ans: \_\_\_\_\_ cm

- 34 Dong Jun cut off 4 squares from the edges of a rectangular piece of cardboard. The area of each small square that he cut off was  $4 \text{ cm}^2$ . Find the area of the remaining cardboard.

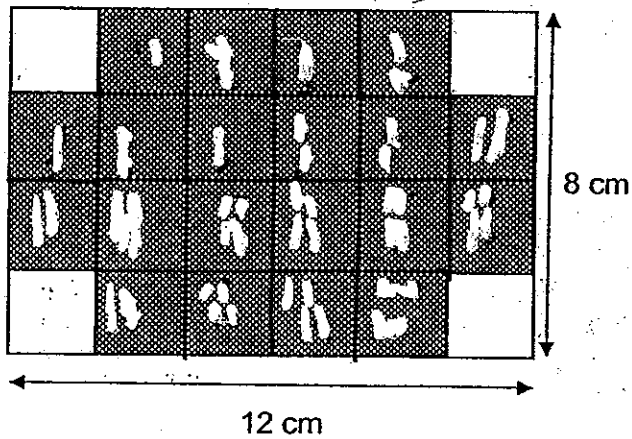

Ans: \_\_\_\_\_  $\text{cm}^2$

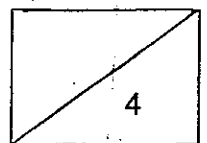

**Section C**

Questions 35 to 38 carry 3 marks each. Questions 39 to 43 carry 4 marks each. Show your working clearly in the space provided below each question and write your answers in the spaces provided. (32 marks)

---

- 35 Mrs Lim wants to buy a dressing table and a bed from a furniture shop. The dressing table costs \$152. The bed costs 5 times as much as the dressing table. How much does she have to pay in total?

Ans: \_\_\_\_\_ [3]

---

- 36 James earned \$270 in a week. He spent  $\frac{5}{9}$  of it and saved the rest. How much did he save in 4 weeks?

Ans: \_\_\_\_\_ [3]

---

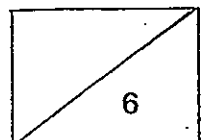

- 37 Study the composite figure below. Rectangles A and B are of the same size. Each rectangle can fit two of square C exactly. Find the area of the composite figure.

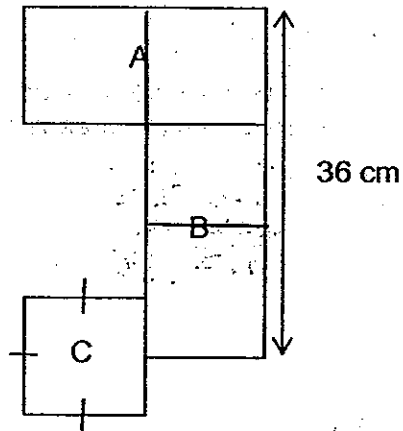

Ans: \_\_\_\_\_ [3]

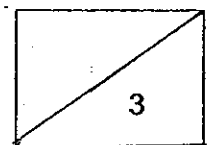

- 38 Jia Jia pasted a rectangular picture on a cupboard measuring 40 cm by 30 cm. He left a 3 cm border all around the picture. What is the area of the cupboard not covered by the picture?

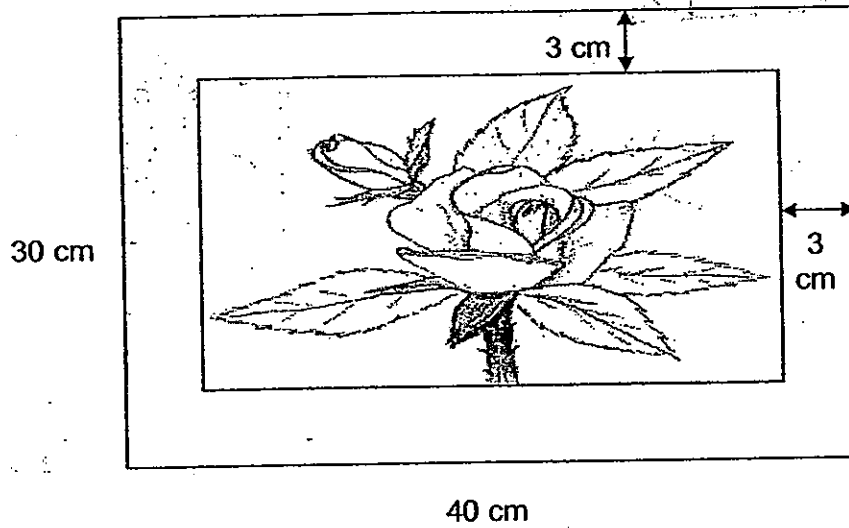

Ans: \_\_\_\_\_ [3]

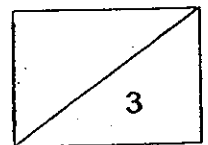

- 39 Shannon and Irfan had 210 stamps. After Shannon gave Irfan 30 stamps, they have the same number of stamps. How many stamps did Irfan have at first?

Ans : \_\_\_\_\_ [4]

- 40 A fruit seller had 30 boxes of apples. There were 48 apples in each box. He sold 510 apples on Monday and 642 apples on Tuesday. He then packed the remaining apples equally into 9 bags. How many apples were there in each bag?

Ans : \_\_\_\_\_ [4]

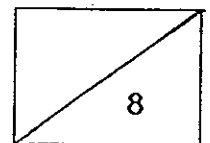



- 41 Devi bought a dress with  $\frac{3}{8}$  of her money. Then she bought a handbag which cost \$15 more than the dress. If she had \$9 left, how much did the dress cost?

Ans: \_\_\_\_\_ [4]

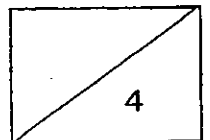

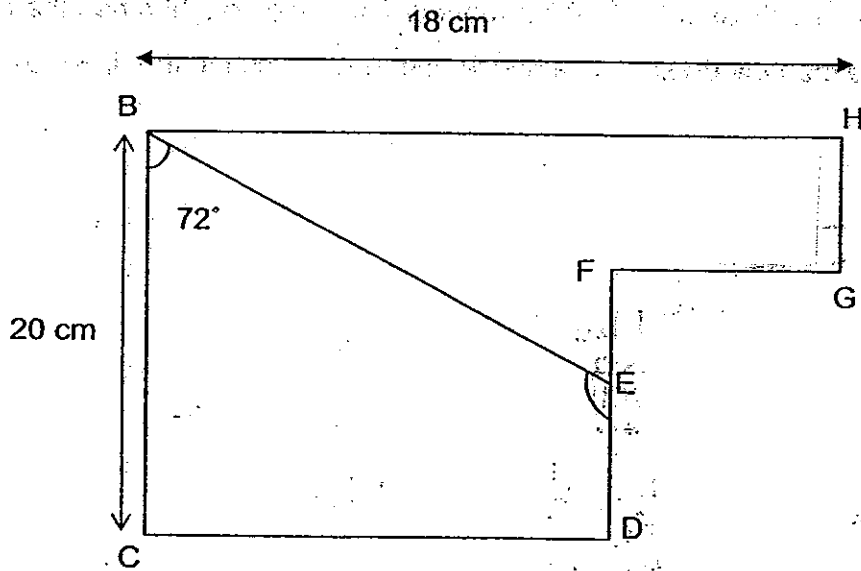

The figure above is not drawn to scale. All lines meet at right angles.

- a) If the length of BC is 4 times the length of HG, find FD.
- b) Name the line that is perpendicular to GH.
- c) Find  $\angle BED$ .

Ans: (a) \_\_\_\_\_ [1]

(b) \_\_\_\_\_ [1]

(c) \_\_\_\_\_ [2]

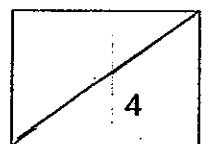

- 43 The sum of a smaller number and a bigger number is 268. When the bigger number is divided by the smaller number, the quotient is 3 with the remainder 4. Find the two numbers.

Ans: \_\_\_\_\_ and \_\_\_\_\_ [4]

---

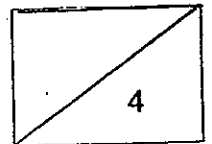

**End-of-paper**

Please check your work carefully.



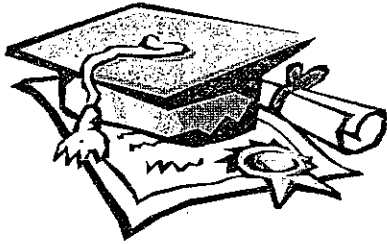

# ANSWER SHEET

**EXAM PAPER 2010**

**SCHOOL : AITONG PRIMARY  
SUBJECT : PRIMARY 4 MATHEMATICS**

**TERM : SA1**

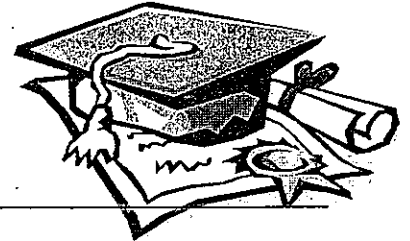

Q1	Q2	Q3	Q4	Q5	Q6	Q7	Q8	Q9	Q10	Q11	Q12	Q13	Q14
2	2	3	1	4	2	2	3	3	3	4	3	2	2

- 15)45060                      16)5107                      17)28                      18)10347                      19)25/7
- 20)185                      21)347                      22)4 $\frac{1}{3}$                       23)24                      24)23<sup>rd</sup> may
- 25)98                      26)North-west                      27)33°                      28)2 pairs                      29)
- 30)31°                      32)72cm<sup>2</sup>                      33)3                      34)80cm<sup>2</sup>

35)\$152 x 5 = \$760  
\$760 + \$152 = \$912  
She has to pay \$912 in total.

36) $1 - \frac{5}{9} = \frac{4}{9}$   
 $\frac{4}{9} \times \$270 = \$120$   
 $\$120 \times 4 = \$480$   
He saved \$480 in 4 weeks.

37) $36\text{cm} \div 3 = 12\text{cm}$   
 $12\text{cm} \times 12\text{cm} = 144\text{cm}^2$   
 $144\text{cm}^2 \times 5 = 720\text{cm}^2$   
The area of the composite figure is 720cm<sup>2</sup>

38) $40\text{cm} \times 30\text{cm} = 1200\text{cm}^2$   
 $40\text{cm} - 3\text{cm} - 3\text{cm} = 34\text{cm}$   
 $34\text{cm} \times 24\text{cm} = 816\text{cm}^2$   
 $1200\text{cm}^2 - 816\text{cm}^2 = 384\text{cm}^2$   
The area of the cupboard not covered by the picture is 384cm<sup>2</sup>

39) $210 \div 2 = 105$   
 $105 - 30 = 75$   
Irfan had 75 stamps at first.

40)  $48 \times 30 = 1440$

$1440 - 510 - 642 = 288$

$288 \div 9 = 32$

There were 32 apples in each bag.

41)  $2 \text{ units} \rightarrow \$15 + \$9$

$2 \text{ units} \rightarrow \$24$

$1 \text{ unit} \rightarrow \$24 \div 2 = \$12$

$3 \text{ units} \rightarrow \$12 \times 3 = \$36$

The dress cost \$36

42) a) Length of BC = 20cm

Length of HG =  $20\text{cm} \div 4 = 5\text{cm}$

Length of FD =  $20\text{cm} - 5\text{cm} = 15\text{cm}$

b)  $BH \perp GH$

c)  $360^\circ - (72^\circ + 90^\circ + 90^\circ) = 108^\circ$

$\angle BERD$  is  $108^\circ$

43) 66 and 202