



**NANYANG PRIMARY SCHOOL**  
**FIRST SEMESTRAL EXAMINATION**  
**2009**

**PRIMARY 4**  
**MATHEMATICS**

**DURATION: 1 HOUR 45 MINUTES**

<b>Section A</b>	<b>/ 40</b>
<b>Section B</b>	<b>/ 40</b>
<b>Section C</b>	<b>/ 20</b>

<b>Total:</b>	<b>/ 100</b>
---------------	--------------

Name: \_\_\_\_\_ (       )

Class: Primary 4 (       )

Date: \_\_\_\_\_

Parent's Signature: \_\_\_\_\_

DO NOT OPEN THIS BOOKLET UNTIL YOU ARE TOLD TO DO SO.

FOLLOW ALL INSTRUCTIONS CAREFULLY.

ANSWER ALL QUESTIONS.

**Section A**

Questions 1 to 20 carry 2 marks each. For each question, four options are given. One of them is the correct answer. Make your choice (1, 2, 3 or 4). Shade the oval (1, 2, 3 or 4) on the Optical Answer Sheet.

(Total: 40 marks)

1. Which of the following is a factor of 76?

(1) 5  
(3) 3

(2) 6  
(4) 4

2. Find the product of 2568 and 8.

(1) 16 084  
(3) 20 484

(2) 18 084  
(4) 20 544

3. What is the missing number in the box?

$$130 \times 4 \times 4 \times 6 = 520 \times \square$$

(1) 10  
(3) 96

(2) 24  
(4) 12 480

4. After making a  $270^\circ$  anti-clockwise turn, Joseph is now facing East. Where was he facing at first?

(1) North  
(3) East

(2) South  
(4) West

5. In the figure below, which of the following is the best estimate for  $\angle x$ ?

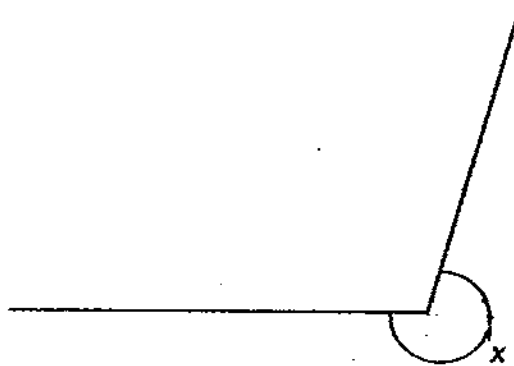

- (1)  $50^\circ$                       (2)  $130^\circ$   
(3)  $230^\circ$                     (4)  $260^\circ$

6. The area of a square is  $64 \text{ cm}^2$ . Find the length of each side of the square.

- (1)  $32 \text{ cm}$                       (2)  $16 \text{ cm}$   
(3)  $8 \text{ cm}$                         (4)  $4 \text{ cm}$

7. List the common factors of 16 and 48 that are greater than 2.

- (1) 3, 6, 16                      (2) 6, 8, 12  
(3) 8, 9, 12                      (4) 4, 8, 16

8. Which of the following has 7 and 9 as two of its factors?

- (1) 81                              (2) 105  
(3) 126                            (4) 144

9. Hardy and Ray save a total of \$6820 every month. Hardy saves \$1580 more than Ray. If Ray saves the same amount each month, how much does he save in 17 months?

- |              |              |
|--------------|--------------|
| (1) \$5 240  | (2) \$26 860 |
| (3) \$44 540 | (4) \$78 600 |

10. What is the missing number in the box?

$$10 - 4\frac{2}{3} = \frac{\square}{6} + 1\frac{1}{3}$$

- |                    |        |
|--------------------|--------|
| (1) 32             | (2) 24 |
| (3) $5\frac{1}{3}$ | (4) 4  |

11.  $3 + \frac{3}{4}$  is not equal to \_\_\_\_\_.

- |                    |                     |
|--------------------|---------------------|
| (1) $\frac{9}{4}$  | (2) $\frac{15}{4}$  |
| (3) $\frac{30}{8}$ | (4) $\frac{45}{12}$ |

12. Study the number pattern.  
What is the missing number?

4, 28, 196, \_\_\_\_\_, 9604

- |          |          |
|----------|----------|
| (1) 224  | (2) 784  |
| (3) 1372 | (4) 5488 |

13. A cup holds  $\frac{2}{5} \ell$  of water. A pail holds 15 times as much water as the cup. How much water is needed to fill  $1\frac{1}{2}$  pails completely?

- (1)  $1\frac{9}{10} \ell$                       (2)  $16\frac{1}{2} \ell$   
 (3)  $6 \ell$                               (4)  $9 \ell$

14. In the figure shown which is not drawn to scale, PQMN is a rectangle. Find  $\angle PMQ$ .

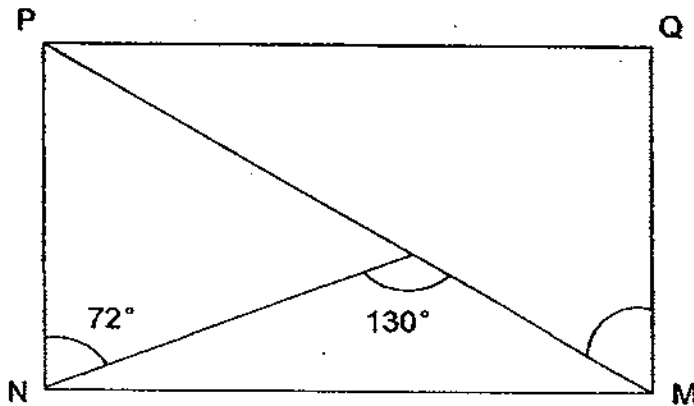

- (1)  $32^\circ$                               (2)  $58^\circ$   
 (3)  $68^\circ$                               (4)  $72^\circ$

15. The figure below is made up of 4 identical squares. The area of the figure is  $144 \text{ cm}^2$ . What is the perimeter of the figure?

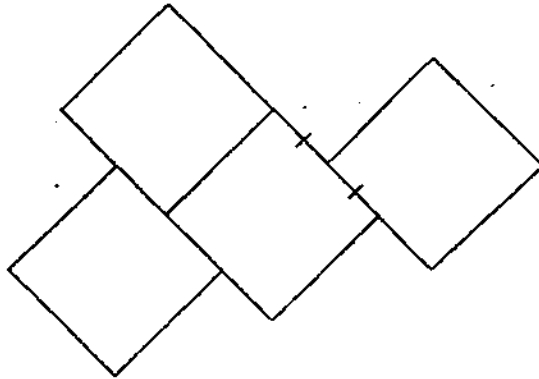

- (1) 60 cm                      (2) 66 cm  
 (3) 72 cm                      (4) 117 cm
16. Alan jogged  $4\frac{5}{8}$  km and Benny jogged  $2\frac{7}{8}$  km more than him. What was the total distance the two boys jogged?
- (1)  $7\frac{1}{2}$  km                      (2)  $11\frac{1}{8}$  km  
 (3)  $12\frac{1}{8}$  km                      (4)  $15\frac{1}{8}$  km
17. Both Cathy and Ned were given \$360 each. Cathy spent  $\frac{5}{8}$  of her money while Ned spent  $\frac{2}{3}$  of his money. They saved the rest of the money. How much more did Cathy save than Ned?
- (1) \$15                              (2) \$120  
 (3) \$135                              (4) \$225

18. There are 23 times as many oranges as apples in a fruit shop. If there are 148 apples, how many more oranges than apples are there?

- (1) 3256
- (2) 3381
- (3) 3404
- (4) 3552

19. Mr Tan is 31 years old and his daughter, Sally, is 4 years old now. In how many years' time will Mr Tan be 4 times as old as Sally?

- (1) 5 years
- (2) 6 years
- (3) 9 years
- (4) 10 years

20. In the figure below, the unshaded part is a square with a perimeter of 72 cm. What is the area of the shaded part?

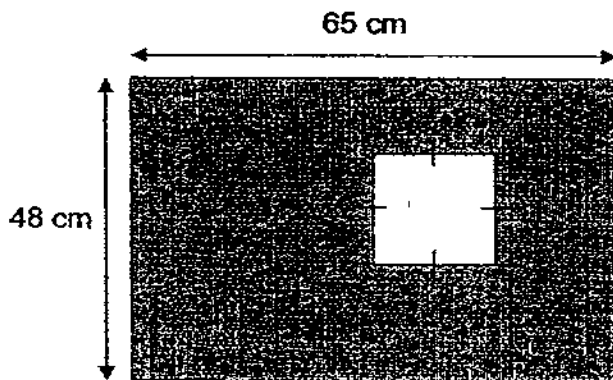

- (1) 324 cm<sup>2</sup>
- (2) 2796 cm<sup>2</sup>
- (3) 3048 cm<sup>2</sup>
- (4) 3120 cm<sup>2</sup>

**Section B**

Questions 21 to 40 carry 2 marks each. Show your working clearly in the space below each question and write your answers in the spaces provided. For questions which require units, give your answers in the units stated.

(Total: 40 marks)

21. Write the following in numerals.

2 ten thousands, 8 thousands, 39 hundreds and 3 ones.

Answer : \_\_\_\_\_

22. (a) Write 47 392 in words.

---

---

(b) Write eighty-one thousand and three in numerals.

Answer : \_\_\_\_\_

23. List all the factors of 48 that are multiples of 6.

Answer : \_\_\_\_\_



24. Mr Gopal had 5890 kg of rice. He sold 309 kg of rice to each of the 8 shopkeepers. How many kilograms of rice did he have left?  
(Round off your answer to the nearest hundred kilogram.)

Answer : \_\_\_\_\_ kg

25. What fraction of the set in the diagram below is shaded?  
Express your answer in its simplest form.

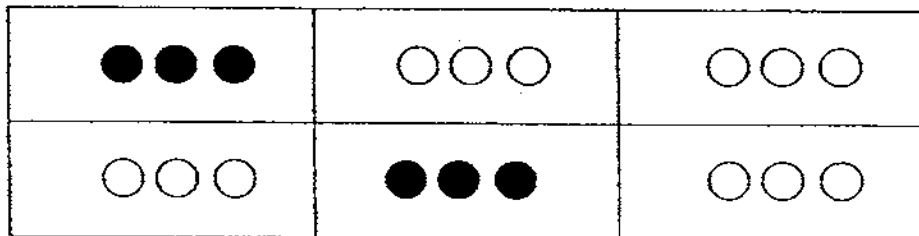

Answer : \_\_\_\_\_

26. The figure shows a line XY. Draw and mark an angle of  $65^\circ$  at X.

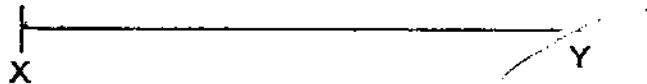

27. Arrange the following numbers in ascending order:

3020 , 3200 , 3002 , 3202

Answer : \_\_\_\_\_

28. The total cost of 4 similar computers is \$8184. If the cost of a computer is twice the cost of a DVD player, find the cost of the DVD player.

Answer : \$ \_\_\_\_\_

29. In the figure below, what is the value of D?

Express your answer as a mixed number in its simplest form.

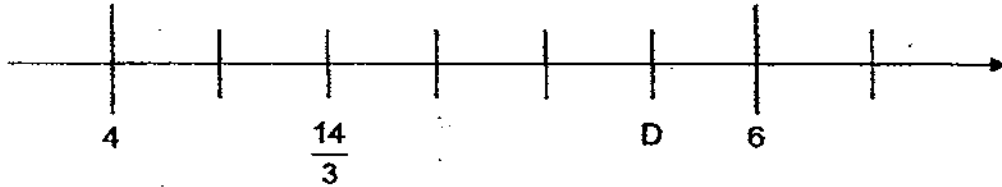

Answer : \_\_\_\_\_

30. A baker used  $17\frac{1}{2}$  kg of sugar to make some cakes and had  $33\frac{5}{6}$  kg of it left. How much sugar did he have at first?  
Express your answer as a mixed number in its simplest form.

Answer : \_\_\_\_\_ kg

31. Two girls, Kim and Lena, are telling each other about their heights. From their conversation, find Lena's height.

Kim: I am  $1\frac{2}{5}$  m tall.

Lena: Kim is  $\frac{1}{10}$  m taller than me.

Answer : \_\_\_\_\_ m

32. At a party,  $\frac{1}{6}$  of the guests were men,  $\frac{7}{12}$  of the guests were women and the rest were children. If there were 36 children at the party, how many men attended the party?

Answer : \_\_\_\_\_

33. In the figure below, PQ, RS and XY are straight lines. Mark an angle that is formed by these lines. This angle has to be greater than  $90^\circ$  but less than  $180^\circ$ . Name the angle  $a$ .

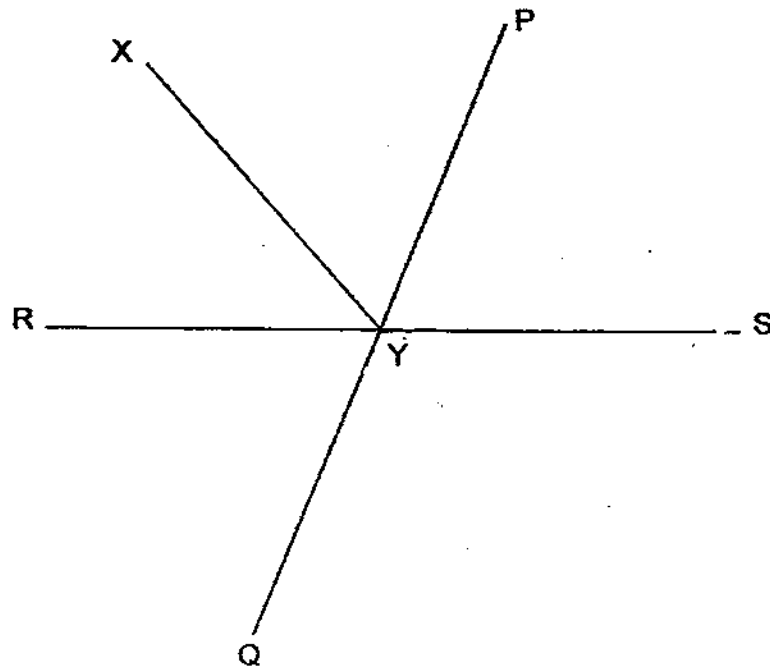

34. Using a set square and a ruler, draw a line perpendicular to PQ through point M.

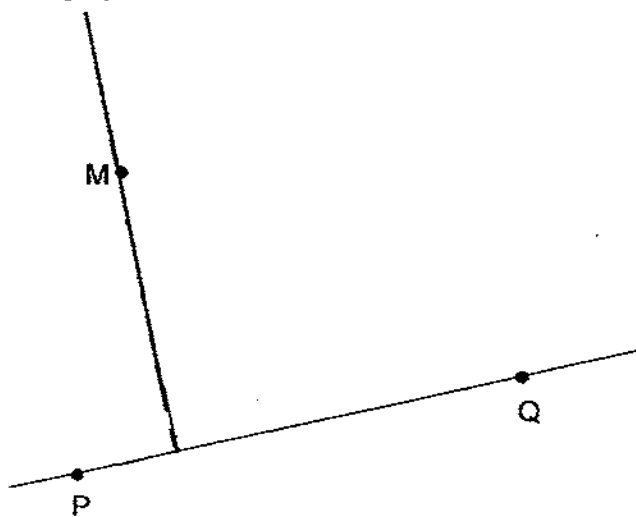

35. In the figure below, EF is twice as long as PQ. Find the length of PQ.

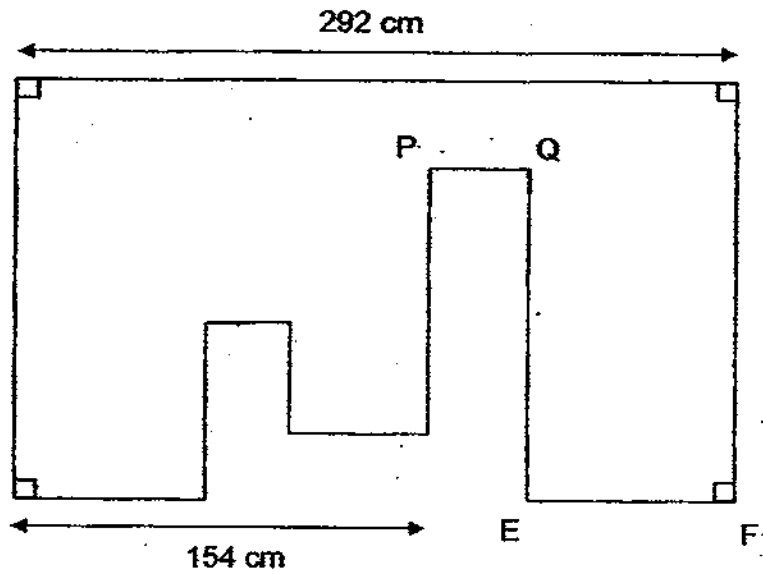

Answer : \_\_\_\_\_ cm

36. A whole number has a value of 29 000 when rounded off to the nearest hundred. Find the smallest possible value of the number.

Answer : \_\_\_\_\_

37. Q is a whole number. It is a common multiple of 6 and 8. When it is added to 35, the result is more than 120 but less than 150. What is the value of Q?

Answer : \_\_\_\_\_

38. Mark saved a sum of money. He spent  $\frac{2}{7}$  of it on a new camera and had \$815 left. How much was Mark's savings?

Answer : \$ \_\_\_\_\_

39. The diagram below shows the different places in Xinli Town Centre.

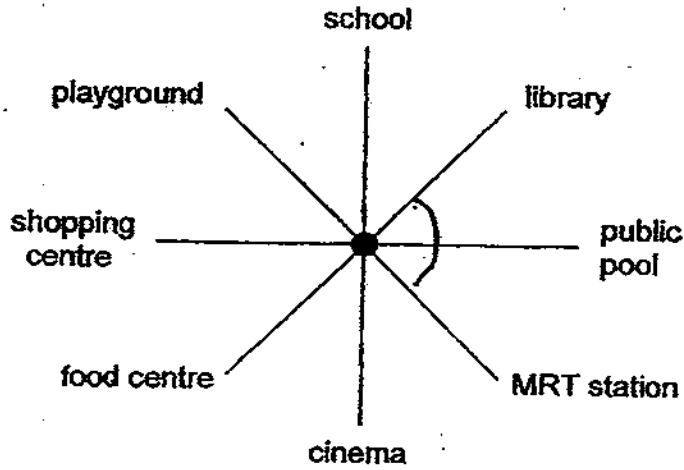

Henry is standing at the spot marked with a ● and facing the library.

What will he face if he makes two  $\frac{1}{4}$  turns clockwise?

Answer : \_\_\_\_\_

40. An athlete ran 4 complete rounds along a rectangular field. The length of the field was thrice its width. Find the length of the field if the total distance he ran was 800 m.

Answer : \_\_\_\_\_ m



**Section C**

Questions 41 to 45 carry 4 marks each. Do these word problems carefully. Show your working clearly in the space provided for each question and write your answers in the spaces provided.

(Total: 20 marks)

41. There are 152 books on Shelf A. The total number of books on Shelf B and Shelf C is five times that on Shelf A. There are 38 fewer books on Shelf B than on Shelf C. How many books are there on Shelf C?

Answer : \_\_\_\_\_

42. Peter had \$40. He spent  $\frac{2}{5}$  of it on a novel and  $\frac{1}{10}$  of it on a poster. Derrick spent  $\frac{3}{4}$  of Peter's total spending on puzzle books. How much more did Peter spend than Derrick?

Answer : \_\_\_\_\_

43. The figure below, which is not drawn to scale, is made up of Rectangle  $ABCF$  and two identical squares. Given that  $AF = EF$ , find  $\angle a$  and  $\angle b$ .

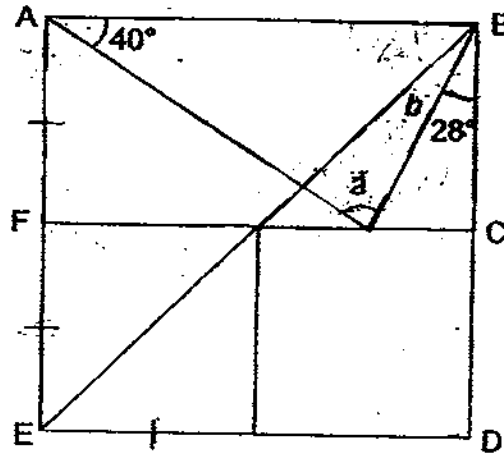

Answer :  $\angle a$ : \_\_\_\_\_

$\angle b$ : \_\_\_\_\_

44. The figure below is made up of identical rectangles each 6 cm long. The perimeter of the figure is 76 cm. Find the area of the shaded part.

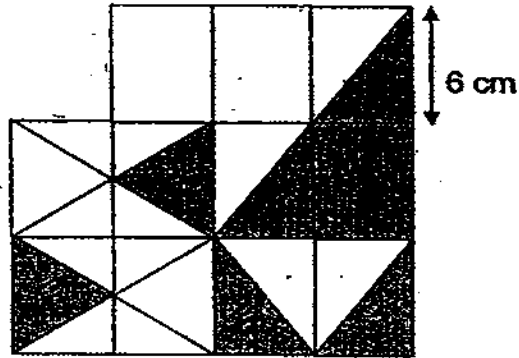

Answer : \_\_\_\_\_

45. After selling  $\frac{7}{8}$  of her red roses, a florist has 4 times as many red roses as white roses. How many roses does she have now if she sold 336 red roses?

Answer : \_\_\_\_\_

**END OF PAPER**

Setters: Mrs Cassandra Ng  
Mdm Anne Kor



# ANSWER SHEET

**EXAM PAPER 2009**

**SCHOOL : NANYANG PRIMARY**  
**SUBJECT : PRIMARY 4 MATHEMATICS**

**TERM : SA1**

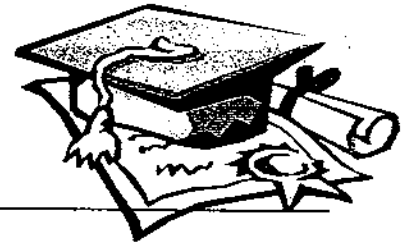

Q1	Q2	Q3	Q4	Q5	Q6	Q7	Q8	Q9	Q10	Q11	Q12	Q13	Q14	Q15	Q16	Q17
4	4	2	1	4	3	4	3	3	2	1	3	4	2	2	3	1

Q18	Q19	Q20
1	1	2

21)31903

22)a)forty-seven thousand, three hundred and ninety-two  
 b)81003

23)6, 12, 24, 48      24)3400kg      25)1/3      26)

27)3002, 3020, 3200, 3202      28)\$1023

29) $5\frac{2}{3}$       30) $51\frac{1}{3}$       31) $1\frac{1}{10}$       32)24

33)

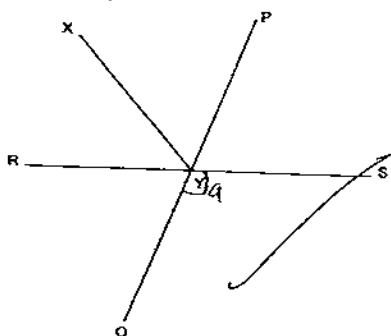

34)

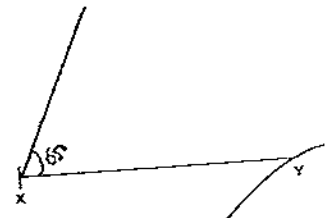
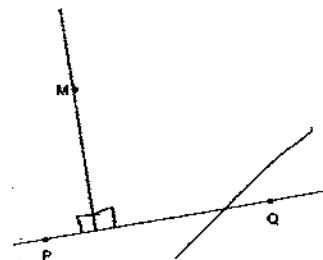

<b>35)46cm</b>	<b>36)28950</b>	<b>37)96</b>	<b>38)\$1141</b>
<b>39)Food centre</b>	<b>40)75m</b>	<b>41)399</b>	<b>42)\$5</b>
<b>43)a)78°</b>	<b>b)17°</b>	<b>44)120cm<sup>2</sup></b>	<b>45)60</b>