



AI TONG SCHOOL

2009

SEMESTRAL ASSESSMENT 1

PRIMARY 4

MATHEMATICS

DURATION : 1 h 45 min

DATE : 14 MAY 2009

INSTRUCTIONS

Do not open the booklet until you are told to do so.

Follow all instructions.

Answer all questions.

Name : _____ ()

Class : Primary 4 _____

Marks:

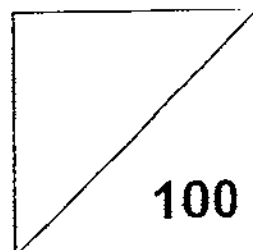

100

Parent's Signature : _____

Date : _____

Section A

Questions 1 to 14 carry 2 marks each. For each question, four options are given. One of them is the correct answer. Make your choice (1, 2, 3 or 4). Shade the oval (1, 2, 3 or 4) on the Optical Answer Sheet with a 2B pencil. (28 marks)

1 What is the best estimate for 979×14 ?

- (1) 900×10
- (2) 900×20
- (3) 1000×10
- (4) 1000×20

2 What is the smallest 3-digit that can be formed with the digits 4, 3 and 9?

- (1) 394
- (2) 943
- (3) 349
- (4) 439

3 $4767 = 15\,000 - \boxed{Z}$

What is the value of **Z**?

- (1) 233
- (2) 7237
- (3) 10 233
- (4) 19 767

4 What does the digit 8 stands for in 84 392?

- (1) 80 000
- (2) 8000
- (3) 800
- (4) 80

5 Which of the following is not a factor of 54?

(1) 27

(2) 18

(3) 16

(4) 9

6 How many sevens are there in 308?

(1) 315

(2) 301

(3) 53

(4) 44

7 Jenny's classmates shared to buy a present for her. 5 boys and 4 girls paid the same amount each for the present. If the present cost \$180, how much did each child pay?

(1) \$18

(2) \$20

(3) \$36

(4) \$90

8 Xiao Ling had 24 cupcakes. She gave 5 cupcakes to each of her two friends. What fraction of her cupcakes had she left?

(1) $\frac{5}{12}$

(2) $\frac{7}{12}$

(3) $\frac{5}{24}$

(4) $\frac{19}{24}$

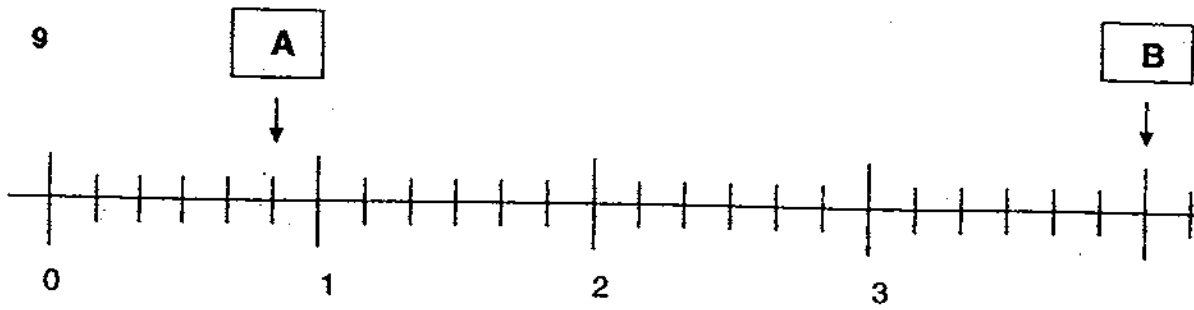

A and **B** are two numbers along the number shown above.
What is the product of **A** and **B**?

(1) $3\frac{1}{6}$

(2) $3\frac{1}{3}$

(3) $4\frac{1}{6}$

(4) $4\frac{5}{6}$

10 Which one of the following has the same value as $3\frac{1}{6}$?

(1) $\frac{31}{6}$

(2) $\frac{24}{6}$

(3) $\frac{19}{6}$

(4) $\frac{10}{6}$

11

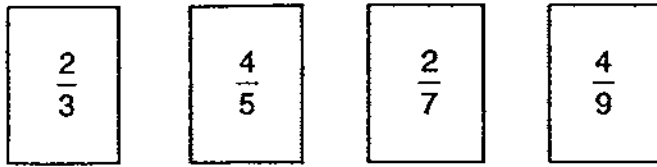

Arrange the four fraction cards above in order from the greatest to the smallest.

- Greatest Smallest
- (1) $\frac{2}{7}$, $\frac{4}{9}$, $\frac{2}{3}$, $\frac{4}{5}$
- (2) $\frac{4}{5}$, $\frac{2}{3}$, $\frac{4}{9}$, $\frac{2}{7}$
- (3) $\frac{2}{3}$, $\frac{4}{5}$, $\frac{4}{9}$, $\frac{2}{7}$
- (4) $\frac{4}{9}$, $\frac{4}{5}$, $\frac{2}{3}$, $\frac{2}{7}$

12 The area of a rectangle is thrice the area of a 6-cm square? If the breadth of the rectangle is 9 cm, what is its length?

- (1) 12 cm
- (2) 18 cm
- (3) 27 cm
- (4) 36 cm

13 Which figure has a perimeter of 24 m?

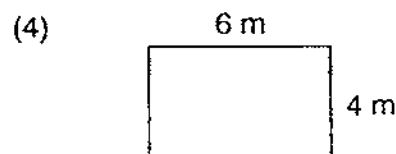
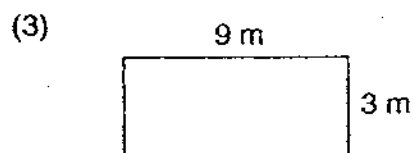
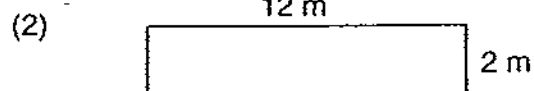
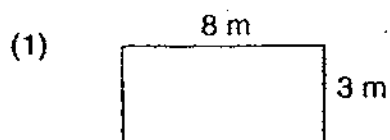

14

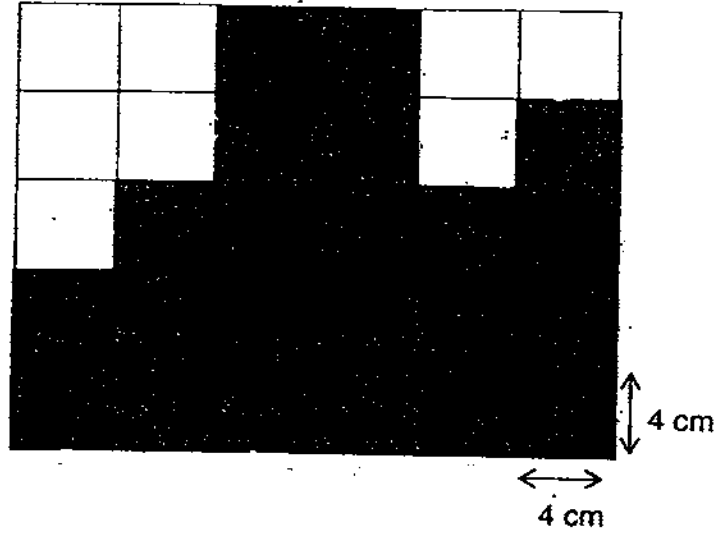

The figure above, not drawn to scale is formed by 4-cm squares. What is the perimeter of the shaded figure?

- (1) 24 cm
- (2) 88 cm
- (3) 96 cm
- (4) 352 cm

Section B

Questions 15 to 34 carry 2 marks each. Write your answers in the spaces provided. For questions which require units, give your answers in the units stated.

(40 marks)

15 Round off 2298 to the nearest ten.

Ans: _____

16 Study the number pattern below carefully. What is the missing number?

555, 1555, 2555, _____, 4555, 5555

Ans: _____

17 Write thirty-five thousand, six hundred and one in figures.

Ans: _____

18 $65\,389 = 9 + 80 + 300 + 5000 +$ _____

What is the missing number?

Ans: _____

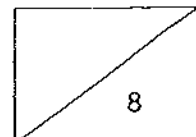

19 How many quarters are there in $3\frac{1}{2}$?

Ans: _____

20 Multiply the third multiple of 2 and second multiple of 3.

Ans: _____

21 What is the remainder when you divide 3689 by 4?

Ans: _____

22 Find the sum of $\frac{1}{6}$ and $\frac{1}{3}$.

Give your answer in the simplest form.

Ans: _____

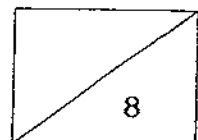

23 My mum spent $\frac{2}{3}$ of her money on groceries and had \$22 left. How much did she spend on groceries?

Ans: \$ _____

24 $1 + 2 + 3 + 4 + \dots + 49 + 50$.
Find the sum of all the whole numbers from 1 to 50.

Ans: _____

25 Susie has 50 beads. 10 of them are red beads. $\frac{1}{2}$ of the remainder are green beads. The rest are black beads. What fraction of the beads Susie has are black?

Ans: _____

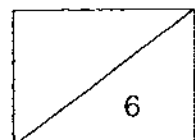

26 ABC is a straight line. $\angle DBE$ is 40° , find $\angle CBE$.

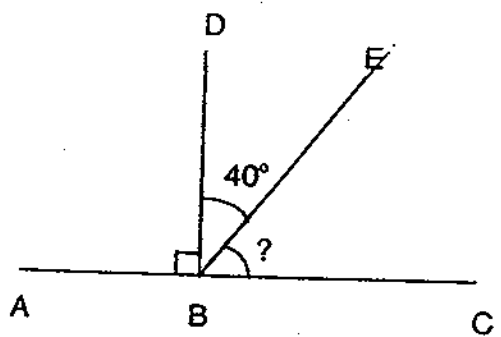

Ans: _____

27 Draw and mark an angle of 160° at point x using the line below.

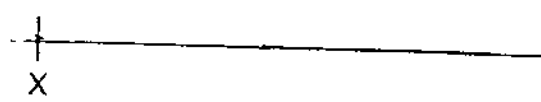

28 How many pairs of parallel lines are there in a rectangle?

Ans: _____

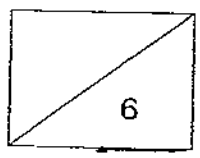

29 AB and BC are perpendicular lines. Find $\angle ABC$.

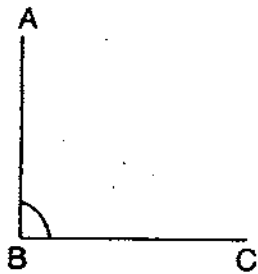

Ans: _____

30 ABCD is a rectangle. $\angle ABD$ is 25° . The figure is not drawn to scale.

- a) Find $\angle ADB$
- b) Find $\angle BDC$

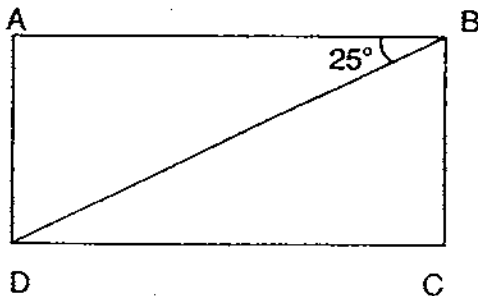

Ans: a) _____

b) _____

31 A figure is made up of a rectangle and a square. The rectangle has a length of 12 cm and a breadth of half of its length. If the area of the figure is 97 cm^2 , what is the area of the square?

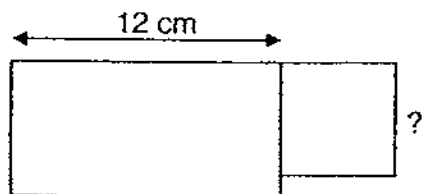

Ans: _____ cm^2

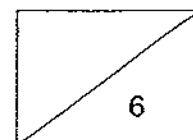

32 Find the length of the unknown side.

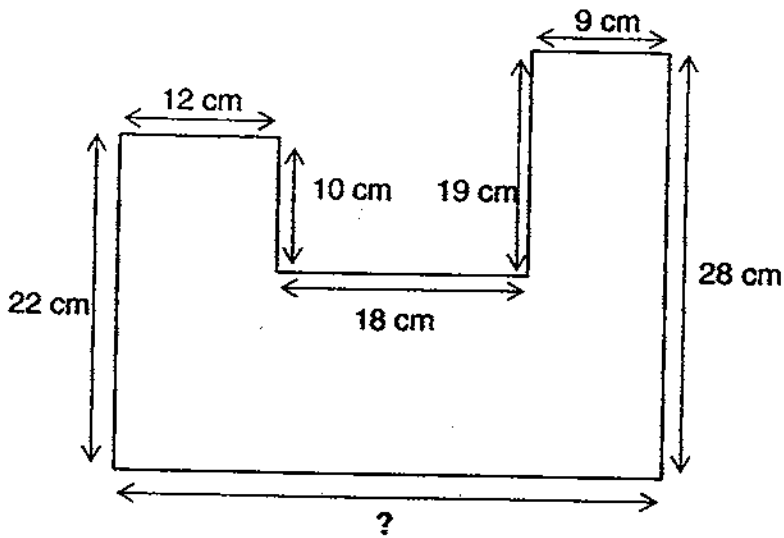

Ans: _____ cm

33 The perimeter of a square is 36 cm. Find the area of the square

Ans: _____ cm²

34 Mona jogged thrice around a rectangular field measuring 50 m by 28 m. What was the distance he jogged?

Ans: _____ m

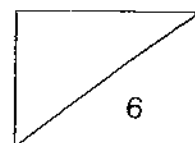

Section C

Questions 35 to 38 carry 3 marks each. Questions 39 to 43 carry 4 marks each. Show your working clearly in the space provided below each question and write your answers in the spaces provided. (32 marks)

- 35 Mimi wants to buy a dress which costs \$253. She only has \$48 in her wallet. She needs to withdraw some money from the ATM machine. The machine can only dispense \$50 notes. Find the least amount of money she must withdraw from the ATM.

Ans: _____ [3]

- 36 Mr Brown rears a few pet rabbits in his garden. He uses a fence 36 m long to enclose an area to keep them in. What is the greatest area that he can enclose with the fence?

Ans: _____ [3]

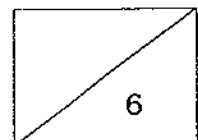

- 37 Mrs Lee baked some muffins. She gave one-quarter of them to her neighbour and one-third of the remainder to her sister. She had 8 muffins left. How many muffins did she bake at first?

Ans: _____ [3]

-
- 38 Mr Lim has a swimming pool that measures 50 m by 30 m. He wanted to re-tile the bottom of the pool. The cost of the re-tilling is \$22 per square metre.
- a) How much does it cost to re-tile the pool?
 - b) He only has a saving of \$23 000 now. If he saves \$500 a month, how many months does he have to save to pay for the work?

Ans: (a) _____ [1]

(b) _____ [2]

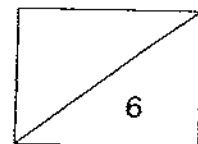

- 39 Edward is 8 years old and his mother is 30 years older than he. How old will Edward be when his mother is thrice his age?

Ans : _____ [4]

- 40 Mrs Kumar imported 347 boxes of mangoes from India. There were 18 mangoes in each box. She threw away 48 rotten mangoes and packed the remaining good mangoes into bags of 6. How many bags of mangoes did Mrs Kumar have?

Ans : _____ [4]

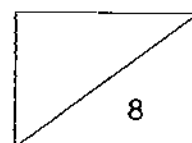

41 An MRT train was $\frac{2}{5}$ full of passengers. At the first station, $\frac{1}{2}$ of the passengers alighted and 17 people boarded the train. The train is now $\frac{1}{4}$ full. How many passengers were there on the train at first?

Ans: _____ [4]

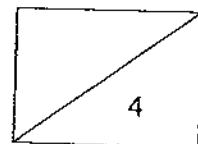

42

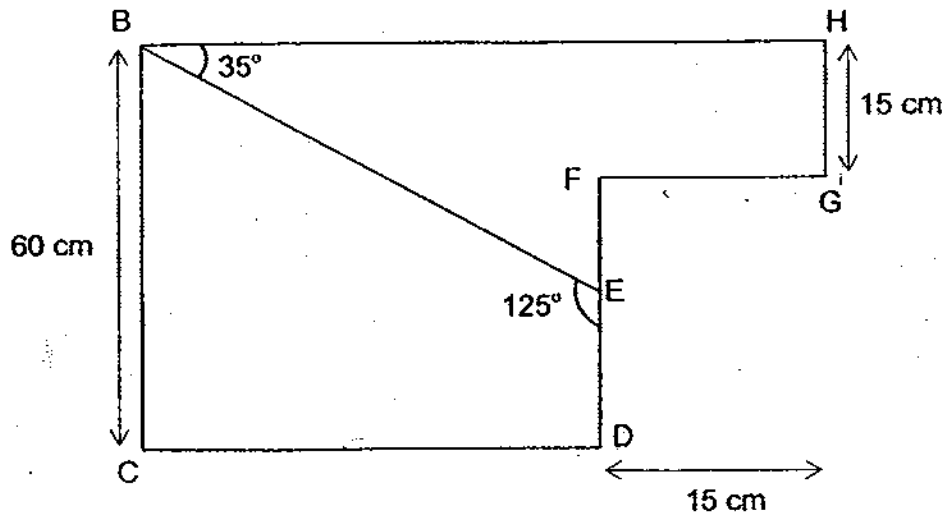

The figure above is not drawn to scale. All lines meet at right angles.

- a) If the length of BH is thrice the length of FG, find CD.
- b) Name a pair of parallel sides.
- c) Find $\angle CBE$.

Ans: (a) _____ [1]

(b) _____ [1]

(c) _____ [2]

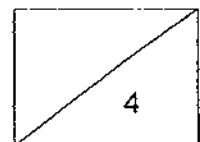

- 43 Robert drank 1ℓ of milk in five days. Each day after the first day, he drank 10 ml more milk than the day before. How much milk did he drink on the first day?

Ans : _____ [4]

End-of-paper

Please check your work carefully.

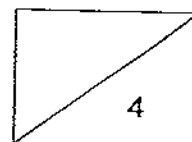



ANSWER SHEET

EXAM PAPER 2009

SCHOOL : AITONG PRIMARY
SUBJECT : PRIMARY 4 MATHEMATICS

TERM : SA1

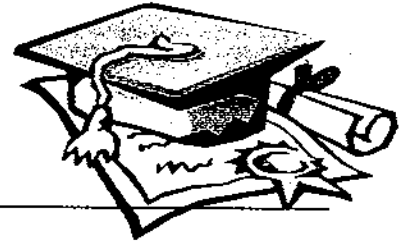

Q1	Q2	Q3	Q4	Q5	Q6	Q7	Q8	Q9	Q10	Q11	Q12	Q13	Q14
3	3	3	1	3	4	2	2	2	3	2	1	3	3

- 15)2300 16)3558 17)35601 18)60000 19)14 20)36
 21)1 22) $\frac{1}{2}$ 23)\$44 24)1275 25) $\frac{2}{5}$ 26) 50°
 27) 28)2 pairs 29) 90° 30)a) 65° b) 25° 31)25cm²

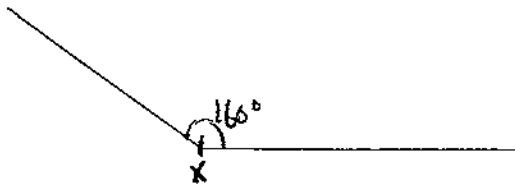

- 32)39cm 33)81cm² 34)468m 35)\$250 36)81m² 37)16
 38)a)\$33000 b)20 39)15 years old 40)1033 41)136
 42)a)30cm b)BH//CD c) 55° 43)180ml