



RED SWASTIKA SCHOOL

RED SWASTIKA SCHOOL

2009 CONTINUAL ASSESSMENT 2

MATHEMATICS

Name : _____ ()

Class : Primary 4 / _____

Date : 25 August 2009

BOOKLET A

20 Questions

40 Marks

Duration of Paper : 1 hour 45 minutes

Note:

1. Do not open this Booklet until you are told to do so.
2. Questions 1 - 20 are to be done on the OAS provided.
3. Read carefully the instructions given at the beginning of each part of the Booklet.
4. Do not waste time. If a question is difficult for you, go on to the next one.
5. Check your answers thoroughly and make sure you attempt every question.

Questions 1 to 20 carry 2 marks each. For each question, four options are given. One of them is the correct answer. Make your choice (1, 2, 3 or 4). Shade the correct oval (1, 2, 3 or 4) on the Optical Answer Sheet.

(40 marks)

-
- 1 In 85 396, the digit 8 is in the _____ place.
- (1) tens
 - (2) hundreds
 - (3) thousands
 - (4) ten thousands
- 2 Mrs Chew bought her refrigerator for \$2 600 when rounded off to the nearest \$100. Which one of the following could be the actual price of the refrigerator?
- (1) \$2 490
 - (2) \$2 540
 - (3) \$2 580
 - (4) \$2 650
- 3 What is the sum of all the factors of 12 which are also multiples of 2?
- (1) 12
 - (2) 20
 - (3) 24
 - (4) 28
- 4 Andrew had some mangoes. He bought another 85 mangoes. He then packed all the mangoes into 14 bags. There are 16 mangoes in each bag. How many mangoes did Andrew have **at first**?
- (1) 115
 - (2) 139
 - (3) 224
 - (4) 309

- 5 $\frac{3}{7}$ has the same value as _____.
- (1) $\frac{1}{7} \times \frac{1}{7} \times \frac{1}{7}$
(2) $3 \times 7 \div 1$
(3) $7 \times \frac{1}{3}$
(4) $\frac{1}{7} + \frac{1}{7} + \frac{1}{7}$
- 6 There were 2 400 people at a fun fair. $\frac{5}{8}$ of them were children. $\frac{3}{5}$ of the children were boys. How many girls were there at the fun fair?
- (1) 600
(2) 900
(3) 960
(4) 1 500
- 7 $\frac{7}{9}$ of the stamps are Singapore stamps and the rest are Malaysia stamps. If there are 45 fewer Malaysia stamps than Singapore stamps, how many stamps are there altogether?
- (1) 35
(2) 81
(3) 90
(4) 225
- 8 How many right angles are needed to make 2 complete turns?
- (1) 6
(2) 2
(3) 8
(4) 4

- 9 The figure below is not drawn to scale. ABC is a straight line. If $\angle y$ is three times of $\angle x$, find the value of $\angle x$.

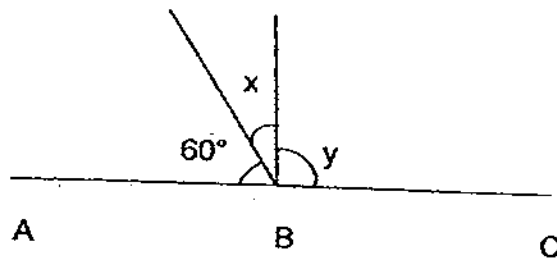

- (1) 30°
 (2) 60°
 (3) 90°
 (4) 120°
- 10 Study the shapes below carefully. How many shape(s) is/are there that has/have both perpendicular and parallel lines?

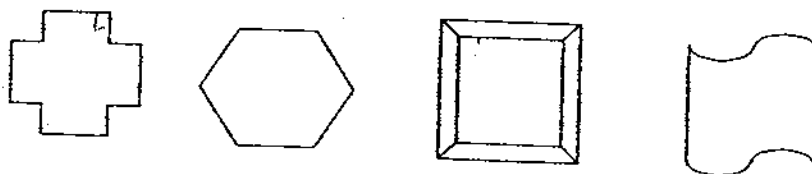

- (1) 1
 (2) 2
 (3) 3
 (4) 4
- 11 Find the pair of parallel lines in the figure below.

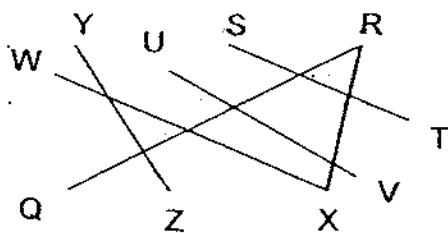

- (1) $UV \parallel YZ$
 (2) $ST \parallel UV$
 (3) $WX \parallel ST$
 (4) $QR \parallel YZ$

- 12 The figure below is not drawn to scale. RST is a straight line and STUV is a square. If $\angle RSW = 32^\circ$. Find the value of $\angle WSV$.

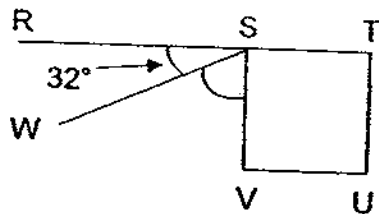

- (1) 13°
- (2) 58°
- (3) 122°
- (4) 148°

- 13 The following figure is made up of a square and a rectangle. ABCD is a square and CDEF is a rectangle. If $\angle BDG = 15^\circ$, find $\angle GDE$.

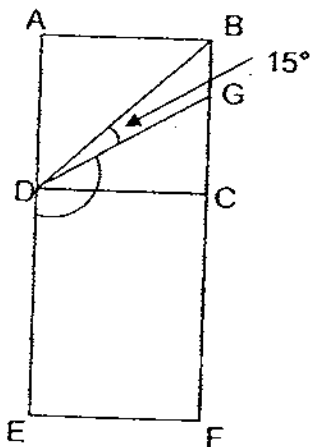

- (1) 30°
- (2) 75°
- (3) 120°
- (4) 135°

- 14 In 94.61, which digit is in the hundredths place?

- (1) 1
- (2) 6
- (3) 9
- (4) 4

- 15 What is the product of 3.06 and 5?
- (1) 1.53
 - (2) 15.3
 - (3) 1 503
 - (4) 1 530
- 16 Mdm Siti bought 4 grapefruits for \$4.80 and 6 apples for \$1.80. Find the difference between the price of a grapefruit and an apple.
- (1) \$0.30
 - (2) \$0.90
 - (3) \$1.20
 - (4) \$3.00
- 17 Susan wants to buy 7 dolls which are selling at the same price. However, she needs another \$11.40 in order to buy them. She then decides to buy 3 dolls instead and has \$20.20 left after that. What is the cost of each doll?
- (1) \$0.88
 - (2) \$3.16
 - (3) \$7.90
 - (4) \$8.80
- 18 Benjamin is thrice as heavy as Audrey. Linda is 3.6 kg heavier than Audrey. Benjamin is 25.8 kg heavier than Linda. Find Benjamin's mass.
- (1) 29.4 kg
 - (2) 44.1 kg
 - (3) 58.8 kg
 - (4) 88.2 kg

- 19 Look at the two clocks shown below carefully. One clock is 10 minutes slower while the other is 15 minutes faster than the actual time. Find the actual time.

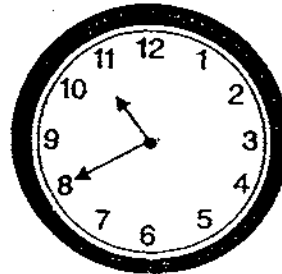
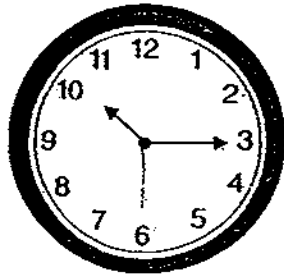

- (1) 10.05 p.m.
- (2) 10.25 p.m.
- (3) 10.30 p.m.
- (4) 10.55 p.m.

- 20 When it is 09 00 in Singapore, it is 13 00 in Japan. A plane took off from Singapore on Monday at 14 30 and flew to Japan. When it landed at Tokyo airport, the time on Tuesday in Japan was 01 00. How long did the flight take?

- (1) 5 h 30 min
- (2) 6 h 30 min
- (3) 10 h 30 min
- (4) 12 h 00 min

Questions 21 to 30 carry 1 mark each. Questions 31 to 40 carry 2 marks each. Show your working clearly in the space below each question and write your answers in the spaces provided. For questions which require units, give your answers in the units stated.

(30 marks)

21 $46\,259 = 40\,000 + \underline{\hspace{2cm}} + 200 + 50 + 9$.
Find the missing number.

Ans:

22 Express $\frac{27}{4}$ as a mixed number.

Ans:

23 $\frac{5}{6} = \frac{\boxed{}}{30}$

What is the missing number in the box?

Ans:

24 How many eighths are there in $3\frac{3}{4}$?

Ans:

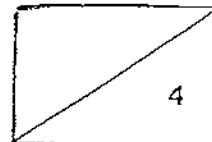



RED SWASTIKA SCHOOL

RED SWASTIKA SCHOOL

2009 CONTINUAL ASSESSMENT 2

MATHEMATICS

Name : _____ ()

Class : Primary 4 / _____

Date : 25 August 2009

BOOKLET B

28 Questions
60 Marks

MARKS

	OBTAINED	POSSIBLE
BOOKLET A		40
BOOKLET B		60
TOTAL		100

Parent's Signature : _____

25 Measure $\angle a$ in the diagram below using a protractor.

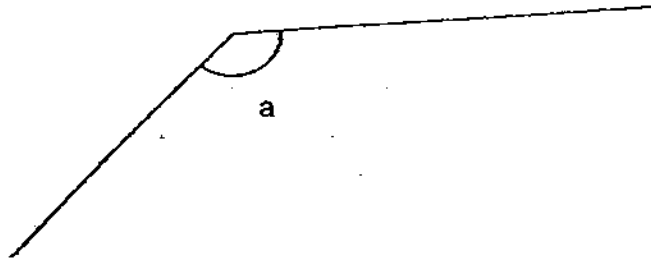

Ans: _____

26 Arrange the following decimals from the greatest to the smallest.

6.308 , 6.038 , 6.380

Ans: _____

27 Write 14 tens, 9 tenths and 2 thousandths as a decimal.

Ans: _____

28 Complete the following number pattern.

0.12 , 0.15 , 0.18 , _____ , 0.24

Ans: _____

29 Find the difference between 9 hundredths and 3 thousandths as a decimal. Round off your answer to 2 decimal places.

Ans: _____

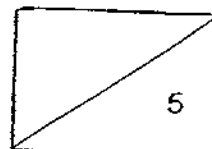

- 30 A football match which lasted for 1 h 15 min ended at 16 00. At what time did the football match begin? Give your answer in 24 hour clock.

Ans: _____

- 31 A number is between 13 and 23. It is a common multiple of 3 and 6. What is the number?

Ans: _____

- 32 Ali sold 9 cartons of dragonfruits. Each carton contained 63 dragonfruits. He sold 3 dragonfruits for \$7. How much did he receive from the sale of all the dragonfruits?

Ans: \$ _____

- 33 $\frac{1}{9}$ of the total number of marbles is the same as $\frac{1}{7}$ of the total number of paper clips. If there are 245 paper clips, find the total number of marbles.

Ans: _____

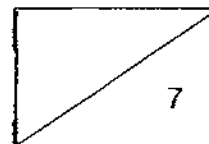

The bar graph below shows the number of stickers collected by three boys. Study the graph carefully and answer the following question.

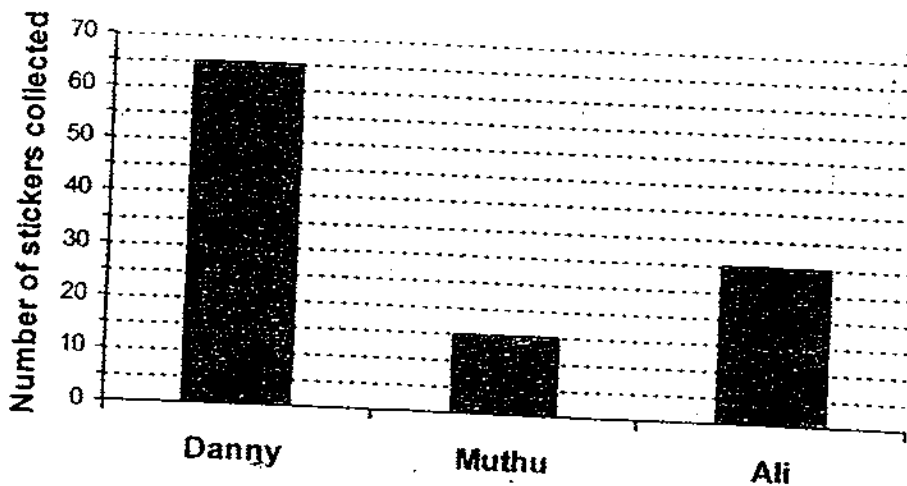

34 How many more stickers did Danny collect than Ali?

Ans: _____

The table below shows how the pupils in 4 A, 4 B and 4 C come to school daily. Study the table carefully and answer the following question.

Class	School Bus	Car	Walk
4 A	15	10	15
4 B	10	16	10
4 C	20	?	10

35 The total number of pupils in 4 A, 4 B and 4 C is 114. Find the total number of pupils from the three classes who come to school daily by car.

Ans: _____

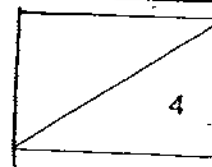

The line graph below shows the number of each type of burgers Mr Hamid sold last week. Study the line graph carefully and answer the following question.

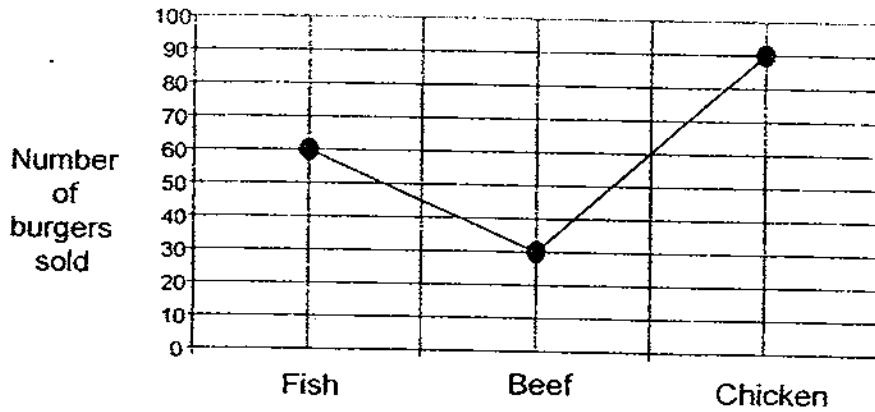

- 36 How many more beef burgers must Mr Hamid sell so that the number of beef burgers sold is half of the number of chicken burgers sold?

Ans: _____

Study the following diagram below carefully and answer the following question.

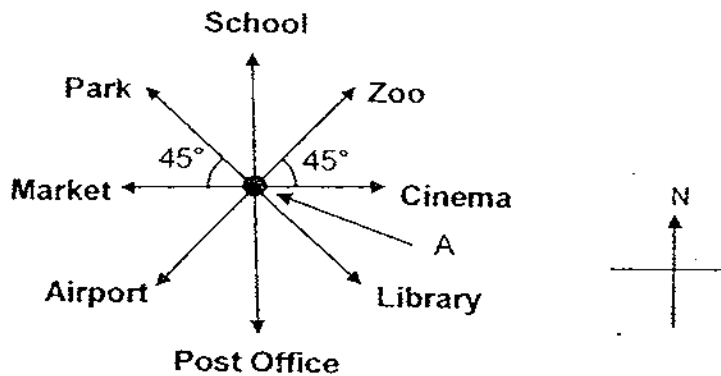

- 37 Timothy is at point A facing north-west. Where will he be facing if he turns 315° in an anticlockwise direction?

Ans: _____

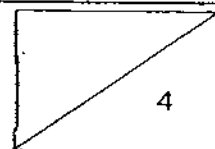

- 38 Look at the figure below. How many pairs of perpendicular lines are there?

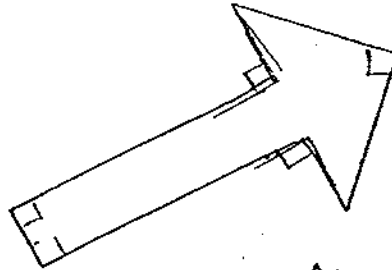

Ans: _____

- 39 Study the figure below carefully. What part of the figure is not shaded? Express your answer as a decimal.

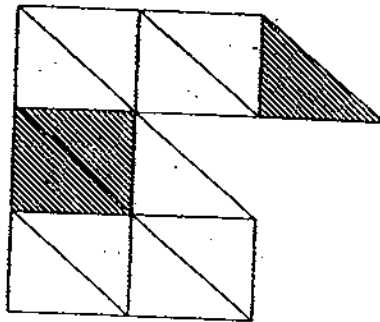

Ans: _

- 40 Miss Tan is a sales promoter. She earns \$12.50 for every pair of shoes sold. She also earns an additional \$20 for every 3 pairs of shoes sold. How much will she earn if she sells 9 pairs of shoes?

Ans: \$ _

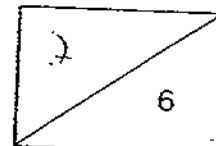

Questions 41 to 42 carry 3 marks each. Questions 43 to 48 carry 4 marks each. Show your working clearly in the space below each question and write your answers in the spaces provided.

(30 marks)

- 41 Mr Lim spends $\frac{3}{10}$ of his salary on transport, $\frac{2}{5}$ of it on food and saves the rest every month. How much does he save every month if his salary is \$2 550?

Ans: _____ [3]

- 42 Maggie spent \$12.60 on a can of soft drink, 2 packets of chips and 4 tins of tuna. The cost of a packet of chips and 2 tins of tuna was \$5.90. What was the cost of a can of soft drink?

Ans: _____ [3]

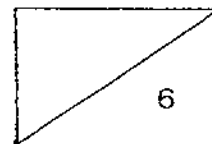

43 Peter had 15 more stickers than Mary. John had 3 times as many stickers as Peter. If the three of them had 455 stickers altogether, how many more stickers had John than Mary?

Ans: _____ [4]

44 Halim had 4 times as many marbles as David. After Halim gave 27 marbles to David, they had the same number of marbles. How many marbles did each of them have now?

Ans: _____ [4]

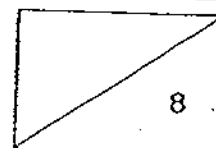

- 45 The total number of pupils in the Chinese Orchestra, Choir and Guzheng is 270. $\frac{4}{9}$ of them are Chinese Orchestra members, 60 pupils are Choir members and the rest of the pupils are Guzheng members. What fraction of the total number of pupils are Guzheng members? (Give your answer in its simplest form.)

Ans: _____ [4]

- 46 There were 2 310 pupils in the hall. After 182 boys and $\frac{2}{5}$ of the girls left the hall, there was an equal number of boys and girls remaining in the hall. How many boys were there in the hall at first?

Ans: _____ [4]

15

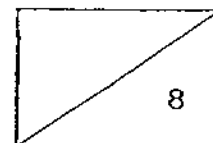

- 47 The figure below, not drawn to scale, is made up of a square ABCD and a rectangle EFGH. BC = 8 m and FG = 20 m. DF is 3 times the length of FC. ED is $\frac{1}{4}$ of the length of FG.

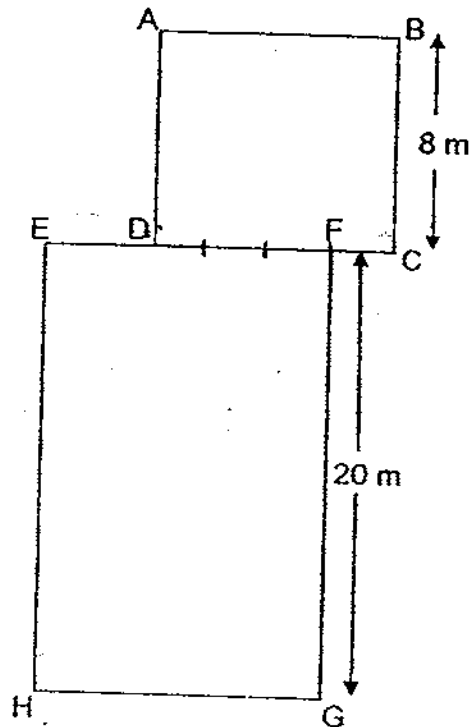

- (a) Find the length of DF.
 (b) Find the length of ED.
 (c) Find the length of HG.

Ans: (a) _____ [1]

Ans: (b) _____ [1]

Ans: (c) _____ [2]

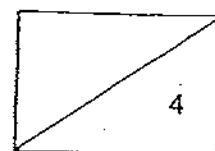

- 48 Sam receives a fixed amount of pocket money every week. If he spends \$1.20 a day for 7 days, he will have \$0.60 left. He decides to spend his pocket money equally over 5 days so that he will have \$2 left as saving. How much will he spend a day on each of the 5 days?

Ans: _____ [4]

END OF PAPER

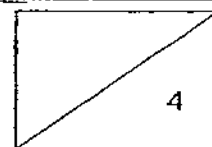

ANSWER SHEET

EXAM PAPER 2009

SCHOOL : RED SWASTIKA PRIMARY
SUBJECT : PRIMARY 4 MATHEMATICS

TERM : CA2

Q1	Q2	Q3	Q4	Q5	Q6	Q7	Q8	Q9	Q10	Q11	Q12	Q13	Q14	Q15	Q16	Q17
4	3	3	2	4	1	2	3	1	2	3	2	3	1	2	2	3

Q18	Q19	Q20
2	2	2

21)6000 22)6¾ 23)25 24)30 25)140°

26)6.380, 6.308, 6.038 27)140.902 28)0.21 29)0.09 30)1445

31)18 32)\$1323 33)315 34)35 35)34 36)15 37)North

38)5 39)0.75 40)\$172.50

41)\$2550 ÷ 10 = \$255
\$255 × 3 = \$765
Mr Lim save \$765 a month.

42)\$5.90 × 2 = \$11.80
\$12.60 - \$11.80 = \$0.80
A car of soft drink cost \$0.80

43)15 × 4 = 60
455 - 60 = 395 (5 units)
395 ÷ 5 = 79 (Mary)
(79 × 15) × 3 = 282
282 - 79 = 203

44)27 ÷ 3 = 9
5 × 9 = 45
Each of them have 45 marbles.

45)1/3

46)2310 - 182 = 2128 (8 units)
2128 ÷ 8 = 266 (1 unit)
(266 × 3) + 182 = 980

47)a)6
b)5
c)11

48)\$1.40