



| | | |
|--------------------------|--------------|--------------|
| Your score upon 80 marks | | |
| Highest score | <u>Class</u> | <u>Level</u> |
| Average score | | |
| Parent's Signature | | |

Name : _____ Class: P 3 _____ Index No: _____

28 October 2005





SCIENCE

ATT: 1h 15 min

SECTION A: Multiple Choice (24 X 2 marks)

There are 24 questions in this section. Answer **all** of them. For each question, 4 suggested answers numbered 1, 2, 3 and 4 are given. Choose the **most** suitable answer and shade the correct oval on the Optical Answer Sheet (OAS).

1. Which one of the following is a living thing?

| | |
|---|---|
| (1)  A cone of ice cream | (2)  A moving train |
| (3)  A rubber duck | (4)  A sleeping cat |

2. The classification table below shows how some living things are grouped.

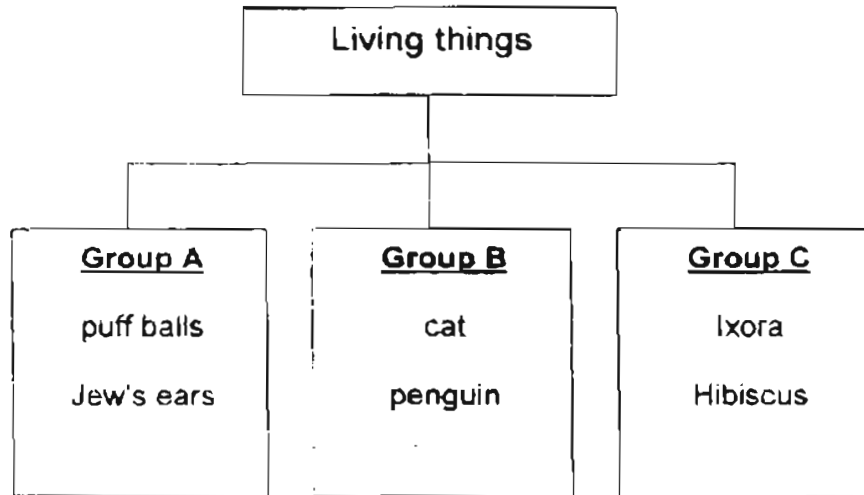

Which one of the following shows the correct heading for each group?

| | Group A | Group B | Group C |
|-----|-----------------|-----------------|----------------|
| (1) | Plants | Fungi | Animals |
| (2) | Micro-organisms | Animals | Plants |
| (3) | Animals | Micro-organisms | Fungi |
| (4) | Fungi | Animals | Plants |

3. Study the classification table below.

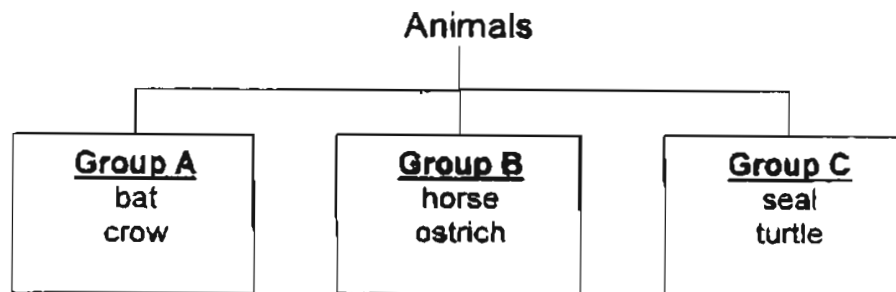

The animals are classified according to _____.

- (1) the food they eat
- (2) the way they move
- (3) their outer coverings
- (4) the way they reproduce

4. Study the flow chart below.

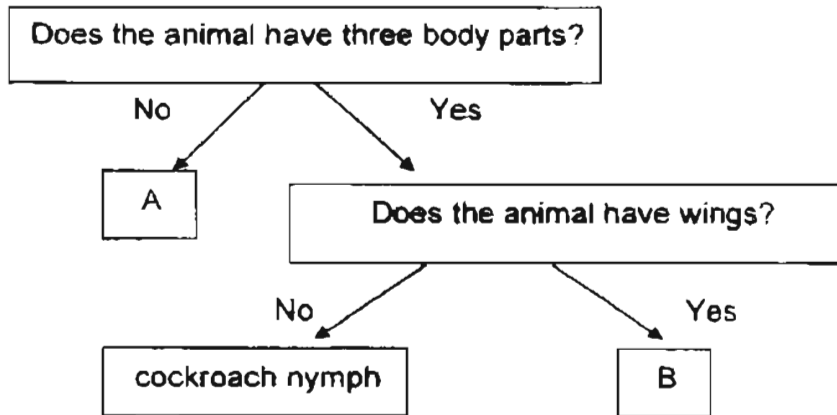

Which one of the following shows correctly what A and B represent?

| | A | B |
|-----|-------|-----------|
| (1) | eel | eagle |
| (2) | snake | mosquito |
| (3) | guppy | emu |
| (4) | ant | dragonfly |

5. In a chicken egg, the _____ is jelly-like and protects the chick.

- (1) egg yolk
- (2) egg shell
- (3) egg white
- (4) membrane

6. The following statements describe Animal X.

- Its larva moults.
- It feeds on nectar.
- It has a four-stage life cycle.

Which one of the following is Animal X?

- (1) chicken
- (2) butterfly
- (3) cockroach
- (4) mealworm

7. Look at the classification table below.

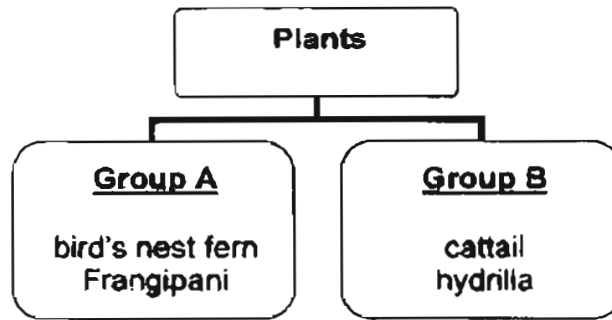

Which one of the following shows correctly what Group A and Group B represent?

| | Group A | Group B |
|-----|----------------------|----------------------|
| (1) | Flowering plants | Non-flowering plants |
| (2) | Non-flowering plants | Flowering plants |
| (3) | Water plants | Land plants |
| (4) | Land plants | Water plants |

8. Which one of the following is a non-flowering plant?

- (1) water lily
- (2) chilli plant
- (3) maidenhair fern
- (4) flame of the forest

9. The pictures below show the different stages of growth of a bean plant.

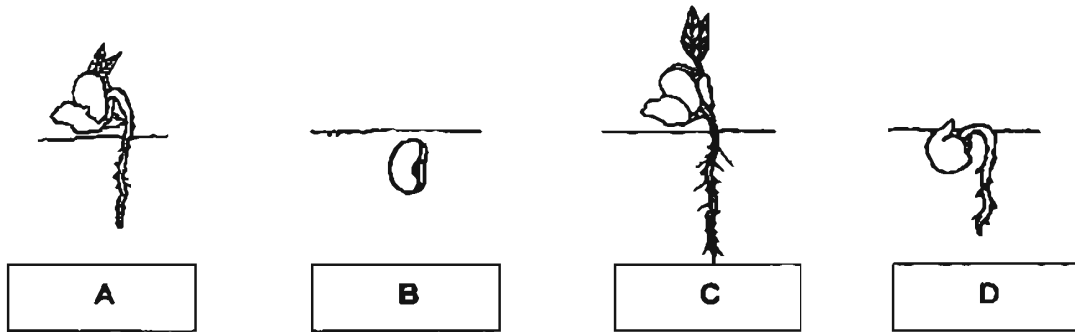

At which stage(s) can the bean plant carry out photosynthesis?

- (1) A only
(2) C only
(3) A and C only
(4) A, C and D only
10. Which one of the following statements about plant parts is false?
- (1) A fruit develops into a flower.
(2) A seed can grow into a plant.
(3) Leaves make food for the plant.
(4) Roots hold a plant firmly in the ground.
11. Which statement(s) about bacteria is/are true?
- A. They are living things.
B. All of them cause diseases.
C. They can only be seen under a microscope.
- (1) A only
(2) B only
(3) A and B only
(4) A and C only

12. Look at the picture below.



A pair of gloves

When Mrs Tan washes clothes, the detergents cause her skin to become red and sore. In order to protect her hands, she puts on this pair of gloves to wash her clothes every day.

The gloves are made of rubber because rubber is _____.

- A. strong
- B. flexible
- C. waterproof

- (1) A and B only
- (2) A and C only
- (3) B and C only
- (4) A, B and C

13. Lisa left her cooking to answer the door. As she looked through the peep-hole of the front door, she suddenly shouted, "My nuggets are burning!" Which organ(s) did she use to detect this?

- A. eyes
- B. ears
- C. nose
- D. tongue





- (1) A only
- (2) C only
- (3) A and C only
- (4) A, B, C and D

14. When we eat a lemon, your **A** smells the fruit and your **B** tastes the sourness. Which one of the following shows correctly what A and B represent?

| | A | B |
|-----|--------|--------|
| (1) | eyes | ears |
| (2) | nose | tongue |
| (3) | tongue | skin |
| (4) | skin | nose |

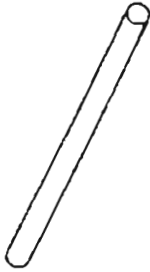
15. Which one of the following organs does not belong to the digestive system?
- (1) tongue
 - (2) kidney
 - (3) stomach
 - (4) large intestine
16. What happens to food when we chew?
- A. It is mixed with saliva.
 - B. It becomes hard and dry.
 - C. It is broken down into smaller pieces.
- (1) A and B only
 - (2) A and C only
 - (3) B and C only
 - (4) A, B and C
17. The function of the skull is to _____.
- (1) help us to think
 - (2) protect the brain
 - (3) protect the spinal cord
 - (4) protect the heart and lungs
18. Which of the following joints allow only back and forth movements in one direction?
- A. neck joint
 - B. knee joint
 - C. elbow joint
 - D. shoulder joint
- (1) A and B only
 - (2) B and C only
 - (3) A, C and D only
 - (4) A, B, C and D
19. We contract and relax the _____ in our legs to enable us to run.
- (1) veins
 - (2) bones
 - (3) nerves
 - (4) muscles

20. Which one of the following can be attracted by a magnet?

| | |
|--|--|
| <p>(1)</p>  <p>A drinking straw</p> | <p>(2)</p>  <p>An eraser</p> |
| <p>(3)</p>  <p>A wooden pencil</p> | <p>(4)</p>  <p>A pair of steel scissors</p> |

21. Look at the picture of a bar magnet shown below.



A bar magnet

A bar magnet was lowered into a box of paper clips. All parts of the magnet came into contact with the paper clips. The bar magnet was then lifted out of the box.

Which part(s) of the magnet is/are likely to attract the most paper clips?

- (1) D only
- (2) C and D only
- (3) A and D only
- (4) B and C only

22. Anna used 2 identical magnets, A and B, of the same size and shape to conduct an experiment. She placed a screw at one pole of Magnet A. Then, she placed another screw at the free end of the first screw. She continued until no more screws could be attracted by the screw above. She did the same thing for Magnet B. The maximum number of screws each magnet could attract is shown in the diagram below.

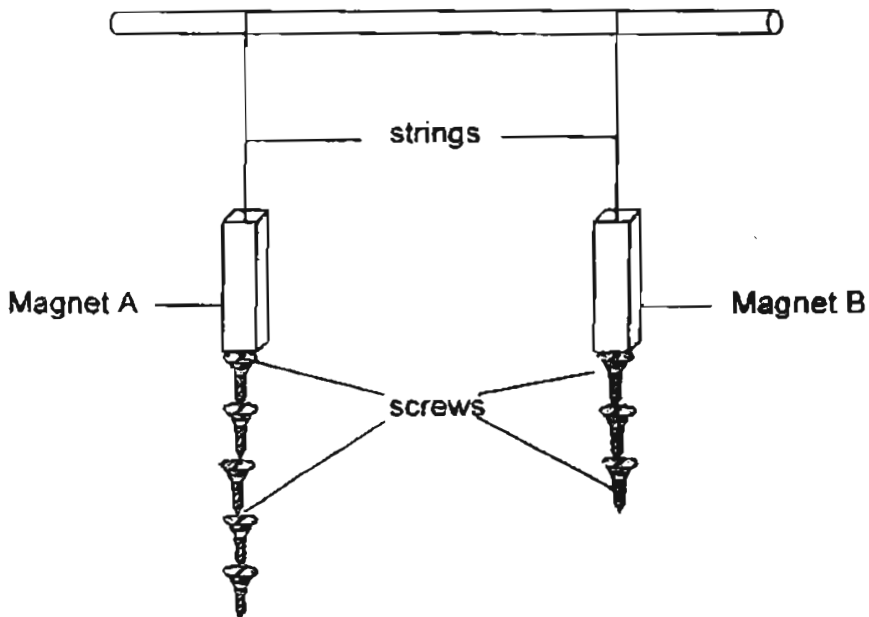

Anna wanted to _____.

- (1) compare the strength of the magnets
- (2) find ways to increase the strength of the magnets
- (3) find out which part of each magnet is the strongest
- (4) find out which objects can be attracted by the magnets

23. Which one of the following will produce the strongest temporary magnet?

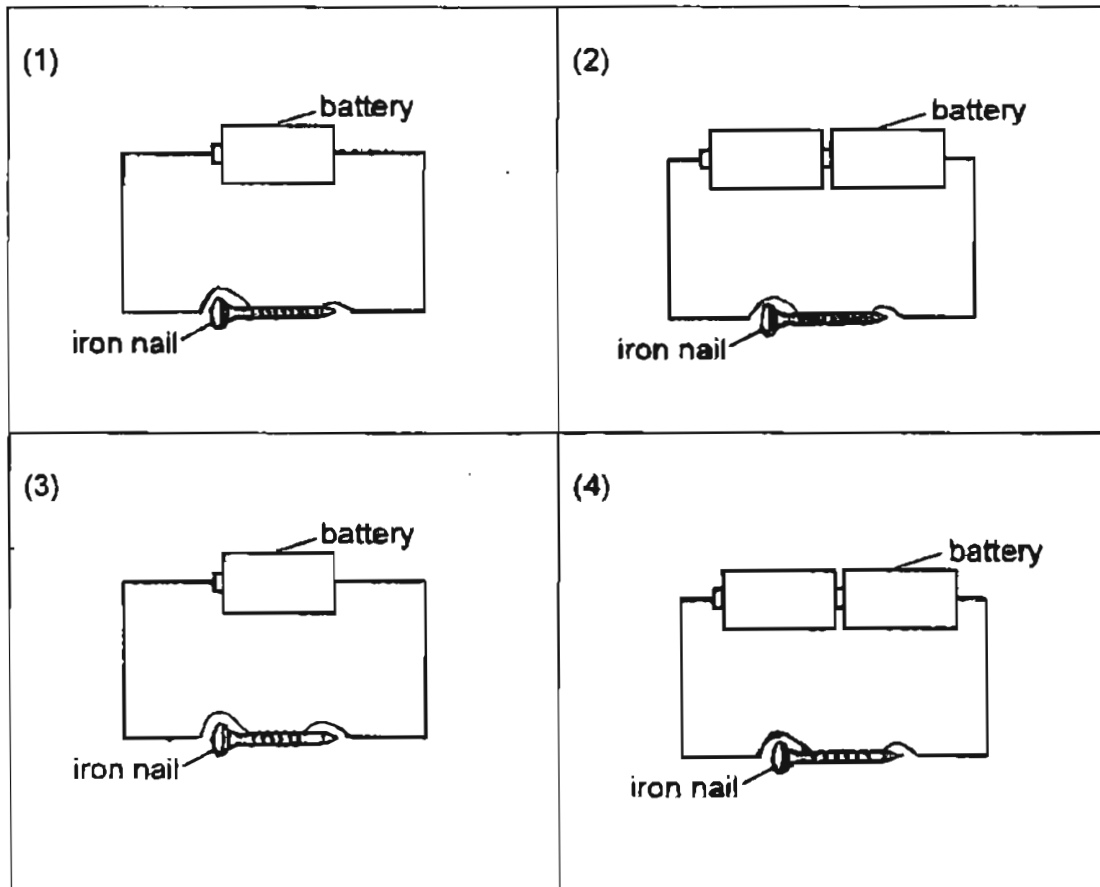

24. Which of these objects make use of magnets?

(A)



a compass

(B)



a refrigerator

(C)



a cooking pan

(D)



a computer

- (1) A and C only
- (2) A and D only
- (3) A, B and D only
- (4) A, B, C and D

SECTION B: Open-ended (32 marks)

There are **16 questions** in this section. Answer **all** of them.

Write your answers in the spaces provided.

25. Each of the following observations is an example of the characteristics of living things. Match the observations to the correct characteristics by joining the boxes on the left to the correct boxes on the right with lines. (2 m)

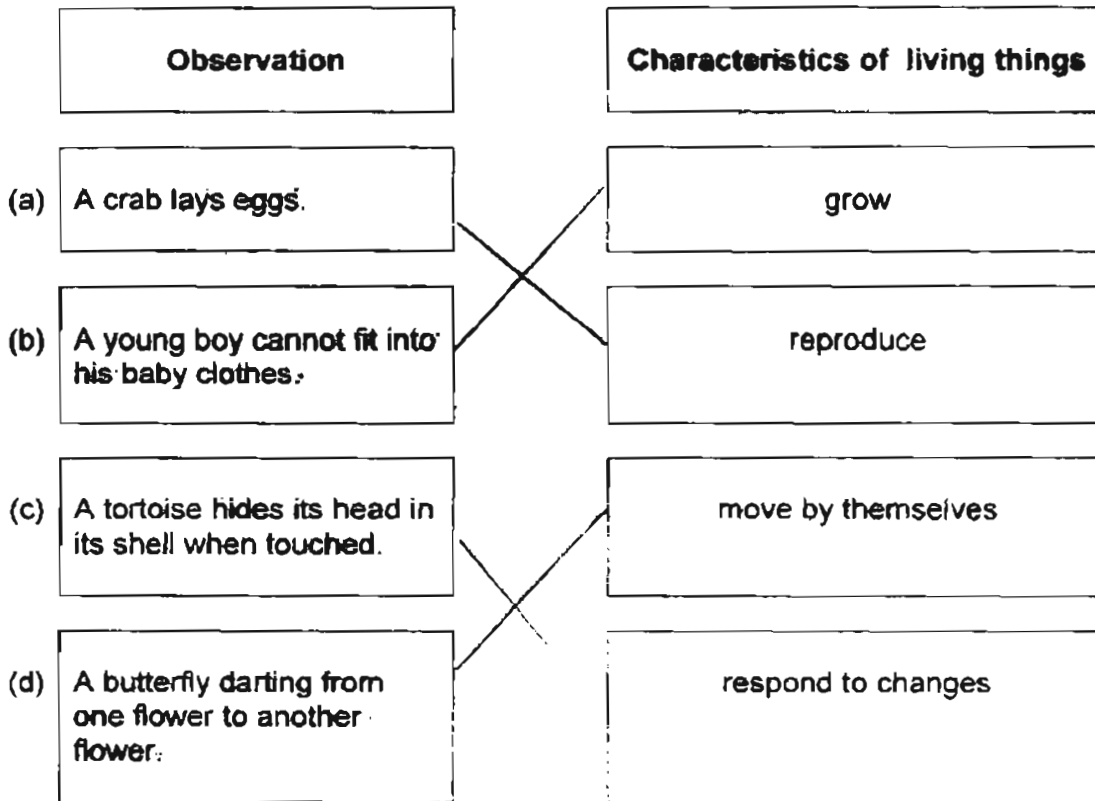

26. Group the following animals according to the food they eat. (2 m)

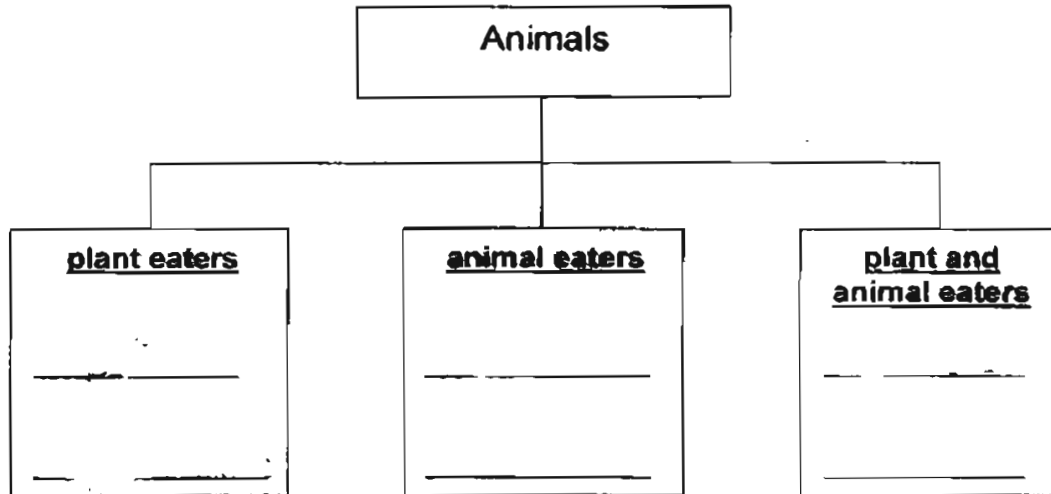
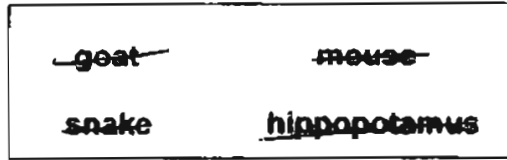

27. The table below shows how animals are classified according to their outer coverings.

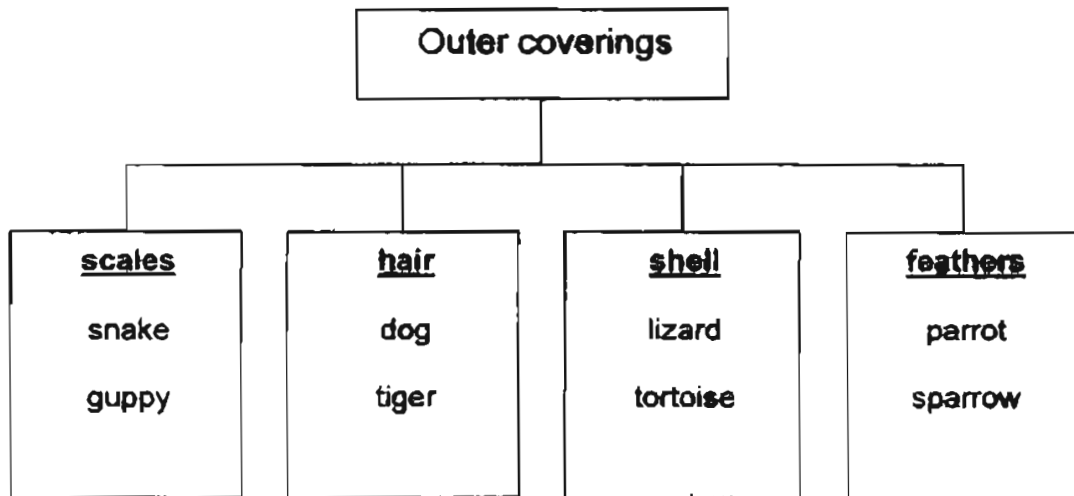

(a) Which animal has been placed in the wrong group? (1 m)

(b) Give a reason for your answer in (a). (1 m)

28. Look at the animal below.



Among the groups which animals can be classified into are: mammals, fish, birds and insects.

(a) Based on what you can see in the picture above, which group of animals does it belong to? (1 m)

(b) Give a reason for your answer in (a). (1 m)

29. (a) The _____ is the larva of a butterfly. (1 m)

(b) The larva of a butterfly moults several times before it becomes an adult. Why does it need to moult? (1 m)

30. Look at the classification table below.

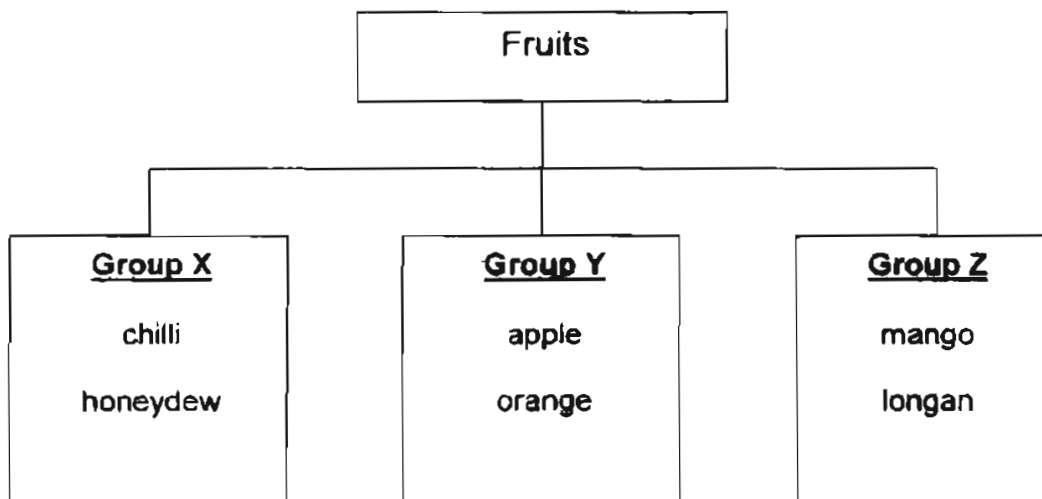

(a) Give suitable headings for Groups X, Y and Z. (1½ m)

X: _____

Y: _____

Z: _____

(b) Give the name of another fruit which can be placed in Group Z. (½ m)

31. Look at the classification table below.

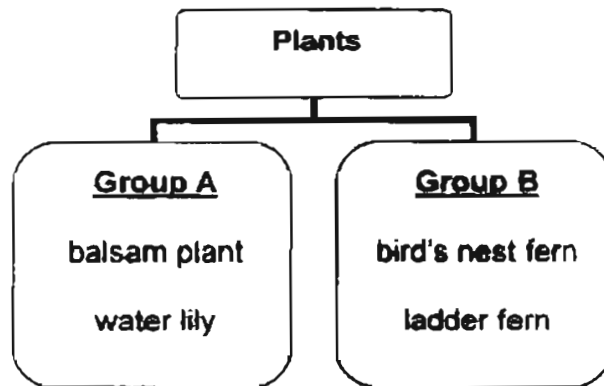

(a) In which group would you place 'moss'? (1 m)

(b) Give a reason for your answer in (a). (1 m)

32. The diagram below shows 3 beakers, A, B and C, containing the same number of seeds each.

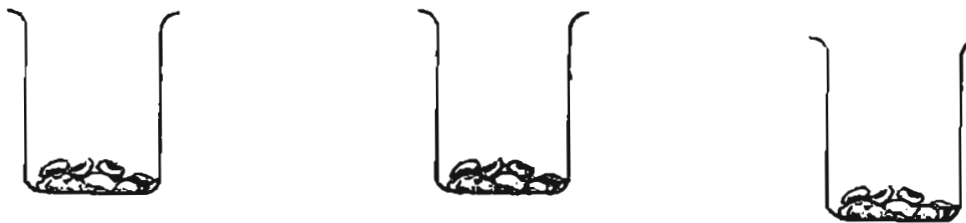

| Beaker A | Beaker B | Beaker C |
|-----------------------|----------------------|------------------------------------|
| dry cotton wool | moist cotton wool | moist cotton wool |
| placed in the freezer | placed near a window | placed in a dark and warm cupboard |

(a) After one week, in which beaker(s) would the seeds germinate? (1 m)

(b) Explain your answer in (a). (1 m)

33. The following diagram shows the process of photosynthesis in plants. Fill in the blanks with the correct answers. (2 m)

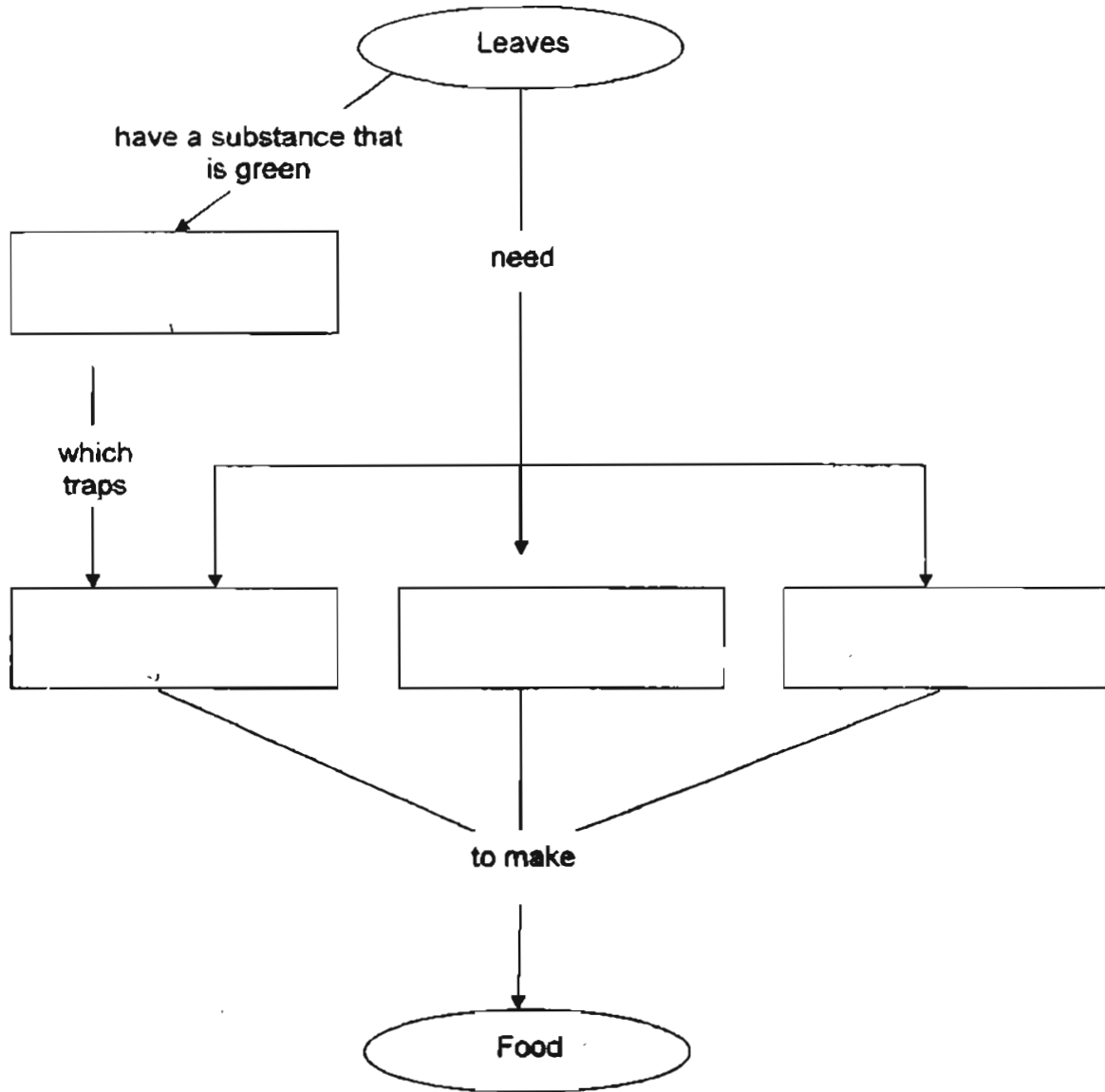

34. Study the classification table below.

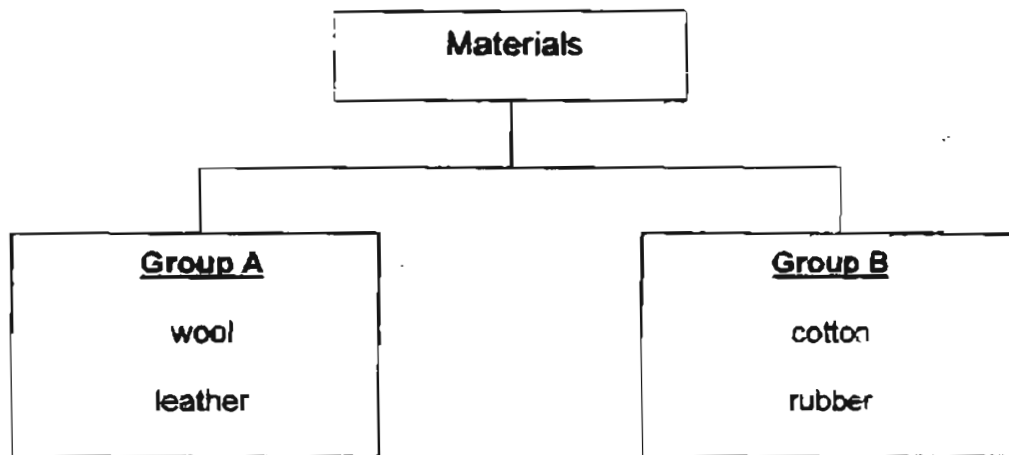

- (a) Materials in Group A come from _____. (½ m)
Materials in Group B come from _____. (½ m)
- (b) The material ~~iron~~ should be placed in Group _____. (1 m)

35. Ahmad made the observations shown in the table below.
Write down the sense organs he used to make the observations. (2 m)

| | Observations | Sense organs |
|-----|---------------------------------|--------------|
| (a) | Silk has a soft texture. | |
| (b) | That is a lovely red dress. | |
| (c) | Lemons have a sour taste. | |
| (d) | Max has a rough and deep voice. | |

36. Complete the table below. (2 m)

| Part of the digestive system | What happens to the food we eat here? |
|------------------------------|---------------------------------------|
| (a) small intestine | |
| (b) large intestine | |

37. Sally has drawn a model of the human skeletal system but she has forgotten to draw in some of the joints. Mark with crosses (X) on the skeleton below, to indicate four joints which she has left out. (2 m)

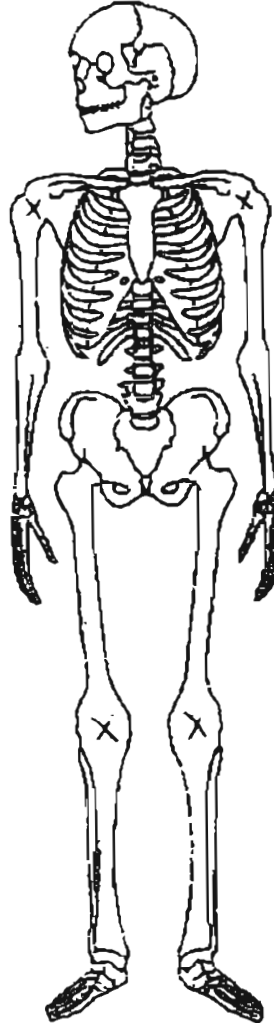

38. Write 'T' for true statement and 'F' for false statement in the brackets provided. (2m)
- (a) Muscles often work in pairs ()
 - (b) Muscles push on bones to make them move. ()
 - (c) If you use your muscles, they become stronger. ()
 - (d) Some of our muscles help us to breathe. ()

39. (a) Ben brought magnet A near an aluminium ring as shown below.

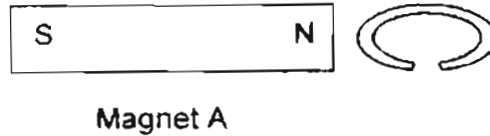

- (i) What will happen to the aluminium ring? ($\frac{1}{2}$ m)

- (ii) Give a reason for your answer in (i). ($\frac{1}{2}$ m)

- (b) Ben brought Magnet B near Magnet A as shown below.
The magnets moved in the direction indicated by the arrows.

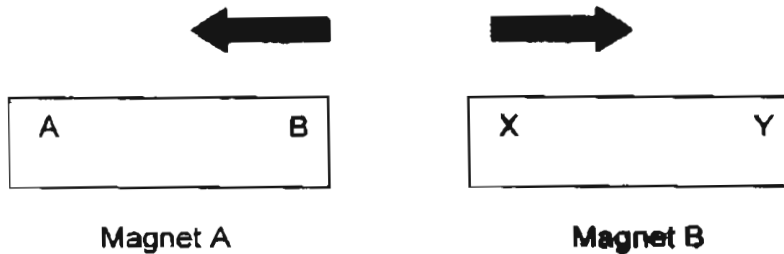

- Why do you think the magnets moved in this way? (1m)

40. Jane magnetized an iron rod by stroking it, a few times in one direction, with a magnet as shown below.

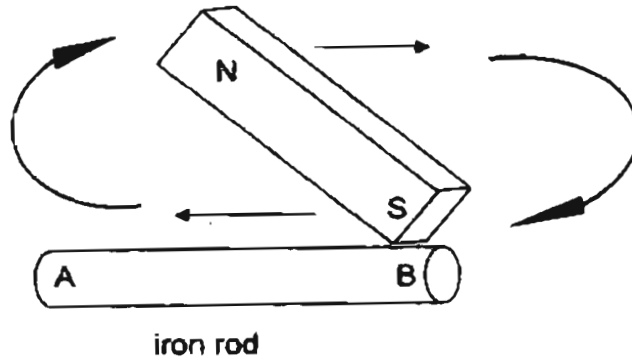

- (a) Using only the objects shown above, what could Jane do if she wanted to increase the strength of the magnetized iron rod? (1 m)

- (b) Jane carried out an experiment. She recorded the number of paper clips the iron rod could attract before and after heating the iron rod for 10 mins. Her results are shown in the table below.

| Number of paper clips attracted by iron rod before heating. | Number of paper clips attracted by iron rod after heating. |
|---|--|
| 10 | 2 |

- What conclusion can Jane draw based on the results she obtained? (1 m)

- END OF PAPER -

Setters:

Miss Marini
Miss Haslina
Mdm Farhana
Mdm Doris Yap

Raffles Girls Primary School
Primary 3 Science SA2 Exams (2005)



Answer Sheets

- 25a. reproduce
- 25b. grow
- 25c. respond to changes
- 25d. move by themselves

26.

| Plant eater | Animal eater | Plant and Animal Eater |
|--------------|--------------|------------------------|
| goat | snake | mouse |
| hippopotamus | | |

- 27a. lizard
- 27b. Lizard is a reptile and reptiles have scales.

- 28a. mammals
- 28b. The animal shown above has hair.

- 29a. caterpillar
- 29b. It moults because it grows and it is too big for its old skin.

- 30a. X : many seeds
 Y : a few seeds
 X : one seed

- 30b. Rambutan

- 31a. Group B
- 31b. Because ladder fern reproduce by spore and the moss reproduce by spores too.

- 32a. Beaker B and Beaker C
- 32b. Seeds need air, water and warmth to germinate.

| | | | | | | | | | |
|-----|-----|-----|-----|-----|-----|-----|-----|-----|-----|
| Q1 | Q2 | Q3 | Q4 | Q5 | Q6 | Q7 | Q8 | Q9 | Q10 |
| 4 | 2 | 2 | 4 | 3 | 2 | 4 | 3 | 3 | 1 |
| Q11 | Q12 | Q13 | Q14 | Q15 | Q16 | Q17 | Q18 | Q19 | Q20 |
| 4 | 3 | 2 | 2 | 2 | 2 | 2 | 2 | 4 | 4 |
| Q21 | Q22 | Q23 | Q24 | Q25 | Q26 | Q27 | Q28 | Q29 | Q30 |
| 3 | 1 | 2 | 3 | | | | | | |

33a.

Chlorophyll

Sunlight

Carbon Dioxide

Water

34a.

animals
Plants

34b.

Group A

35a.

skin

35b.

eyes

35c.

tongue

35d.

ears

36a.

Food is completely digested. The digested food is made of very small particles which passed into the blood vessels.

36b.

Water will be removed from the undigested food.

37.



38a.

True

38b.

False

38c.

True

38d.

True

39a

- (i) Nothing will happen to the aluminium ring.
- (ii) Aluminium is not a magnetic material.

39b.

Like poles are facing each other so they repel.

40a.

Stroke the iron rod more times.

40b.

Heating the magnet will decrease the strength of the magnet.