

NANYANG PRIMARY SCHOOL

SAT

PRIMARY THREE SCIENCE

SEMESTRAL ASSESSMENT 1
2005

BOOKLET A

Date : 6th MAY : 2005

Duration : 1 h 45 min

Name : _____ ()

Class: Primary _____ ()

Marks Scored:

Booklet A:		60
Booklet B :		40
Total :		100

Parent's signature:

**DO NOT OPEN THIS BOOKLET UNTIL YOU ARE TOLD TO DO SO.
FOLLOW ALL INSTRUCTIONS CAREFULLY.**

Booklet A consists of 14 printed pages including this cover page.

Section A (30 x 2 marks = 60 marks)

For each question from 1 to 30, four options are given. One of them is the correct answer. Make your choice (1, 2, 3 or 4). Shade the correct oval (1, 2, 3 or 4) on the Optical Answer Sheet provided.

1. Study the following animals below.



monitor lizard



ostrich

In what ways are they similar?

- A The way they move.
- B Their outer covering.
- C The way they reproduce.
- D They eat both plants and animals.

- (1) A and C only
- (3) C and B only

- (2) A and B only
- (4) C and D only

2. Which of the following organisms have young which do not look like the adult?

- A Dogs
- B Lizards
- C Butterflies
- D Mosquitoes

- (1) A and B only
- (3) B and D only

- (2) A and C only
- (4) C and D only

3. Sally placed two similar goldfishes in separate bowls containing equal amounts of tap water. Bowl A contained a hydrilla plant whereas Bowl B did not. The bowls were placed in the same room and the fishes were fed regularly with equal amounts of food. She found the fish in Bowl B dead after a few days.

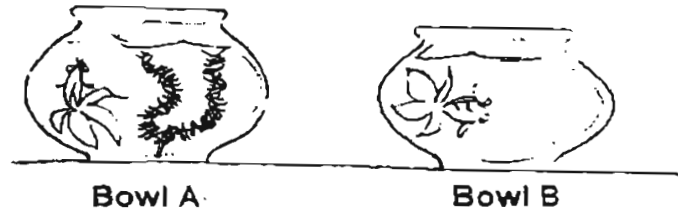

Which one of the following explanations best explains the observation?

- (1) Bowl A had additional food.
 - (2) The water in Bowl B was too hot.
 - (3) The water in Bowl B was too cold.
 - (4) There was not enough air in Bowl B.
4. The diagram below shows two plants, Plant A and B.

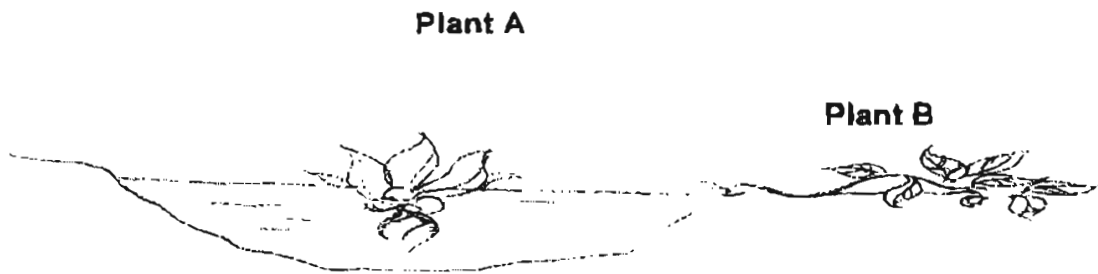

Which functions of the roots of Plant A and B are similar?

- A To hold the plants upright.
 - B To absorb water for the plants.
 - C To absorb nutrients for the plants.
 - D To hold the plant firmly to the ground.
- (1) A and B only.
 - (2) B and C only.
 - (3) A, B and D only.
 - (4) A, C and D only.

5. The diagram below shows a tree that Jack saw on his way to school.

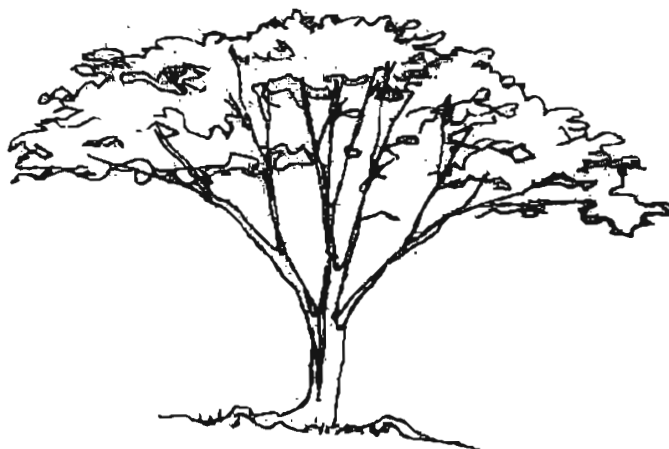

Why are the branches of the tree spread out widely?

- (1) To receive sunlight.
 - (2) To collect rain water.
 - (3) To allow birds to build nests.
 - (4) To provide shade for animals.
6. Susan placed four similar bougainvillea plants labelled in pots A, B, C and D in the same room. Pot C was placed in a locked cupboard. Pot D was put into a sealed container with the ^{air} sucked out. The table shows the different condition that each plant received.

Plant	Water	Fertiliser	Light	Air
A	X	✓	✓	✓
B	✓	X	✓	✓
C	✓	✓	X	✓
D	✓	✓	X	X

✓ provided
X not provided

Which potted plant would still be alive after a month?

- (1) A
- (2) B
- (3) C
- (4) D

7. Kenji, who is 140 cm tall, was walking to school when he passed by some plants. Plant A was about his height. It had flowers and a woody stem. Plant B had a stem that twines around a fence. Which one of the following best describes the plants?

- (1) Plant A is a tree and Plant B is a shrub.
- (2) Plant A reproduce by seeds but Plant B does not.
- (3) Plant A is flowering plant and Plant B is a non-flowering plant.
- (4) Plant A is able to support itself whereas Plant B has a weak stem.

8. The leaves of a rain tree open up during the day and droop at night. Which of the following characteristics of living things did the rain tree show?

- A It needs air.
- B It needs food.
- C It can move on its own.
- D It responds to changes.

- (1) A and B only
- (2) A and C only
- (3) B and C only
- (4) C and D only

9. In what way is a stag's horn fern different from a rose plant?

- (1) A rose plant has fruits but a stag's horn fern does not.
- (2) A rose plant has roots but a stag's horn fern does not.
- (3) A stag's horn fern grows in water but a rose plant does not.
- (4) A rose plant makes its own food but a stag's horn fern does not.

10. Which of the following classification is correct?

(1)

Group A	Group B
Lotus	Arrowhead
Water Lily	Duckweed

(2)

Group A	Group B
Lotus	Arrowhead
Duckweed	Water Lily

(3)

Group A	Group B
Lotus	Water Lettuce
Arrowhead	Duckweed

(4)

Group A	Group B
Lotus	Water Lily
Arrowhead	
Duckweed	

11. Raju noticed that Bird's Nest Fern was growing on a tree in his garden. When asked, his parents denied planting it there. Which one of the following statements best explains how the fern got there?

- (1) It slowly climbed the tree using its roots.
- (2) The bird's nest fern is the young of the tree.
- (3) Wind carried the spores and deposited them there.
- (4) Animals brought it up the tree and used it as a nest.

12. Jane found a strange looking plant near her school's canteen. Upon inspection, she found that it has black particles on the underside of its leaves.

Which one of the following statements is most likely to be true?

- A The black particles are seeds.
- B The black particles are insect's eggs.
- C The black particles are used for reproduction.
- D The black particles are waste materials from the plant.

(1) A and B only

(2) A and D only

(3) B and C only

(4) C and D only

13. Study the pictures below.



Orchid



Hibiscus

Which of the following statements is/are true for the plants?

- A The orchid flowers grow in cluster^s but not the hibiscus.
- B The hibiscus flower has petals but the orchid flowers do not.
- C The hibiscus plant has leaves with toothed edges whereas the orchid plant has leaves with entire edges.

(1) A only.

(2) A and C only

(3) B and C only

(4) A, B and C

14. Which one of the following organisms needs extra nutrients from other living things?

(1)

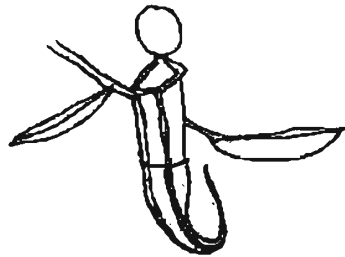

Pitcher Plant

(2)

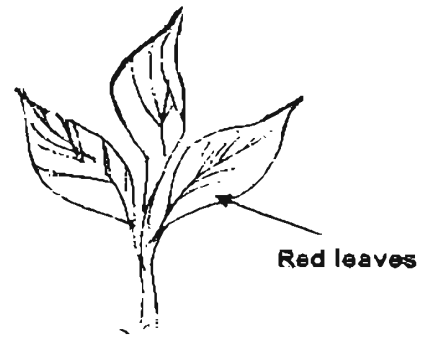

Fireband

(3)



Arrow head

Arrowhead

(4)



Rose

15. Adam divided the following plants into two groups.

Group X	Group Y
Dumbcane	Bougainvillea
Pong Pong	Water Lily

Which one of the following plants can be placed in group X?

- (1) Cattail
- (2) Balsam
- (3) Cabomba
- (4) Periwinkle

16. Siti giggles whenever her mother tickles her cheeks. What characteristics of living things explain the situation above?

- (1) Living things die
- (2) Living things grow
- (3) Living things respond to changes
- (4) Living things needs air, food and water

17. A hen lays some eggs and the eggs then develop into chicks. Which of the following statements describe the process above?

- A Living things grows
- B Living things reproduce
- C Living things respond to changes
- D Living things needs air, food and water

- (1) A and B only
- (2) A and C only
- (3) B and C only
- (4) C and D only

18. Sally tried to group the objects below. However, she grouped one wrongly. Which one of the following is grouped wrongly?

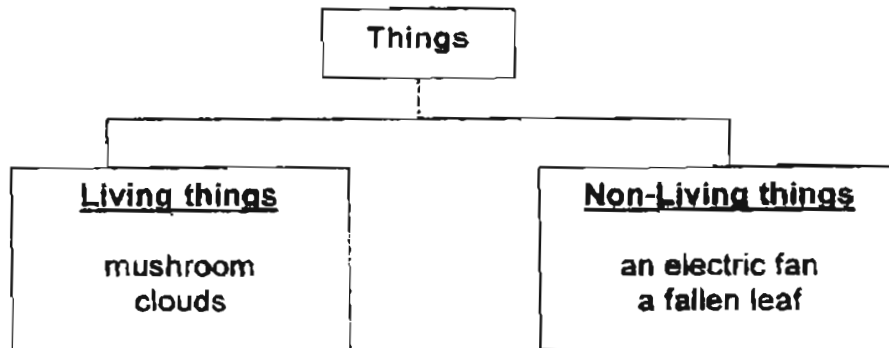

- (1) clouds
- (2) mushroom
- (3) a fallen leaf
- (4) an electric fan

19. Suli has classified some organisms as shown below.

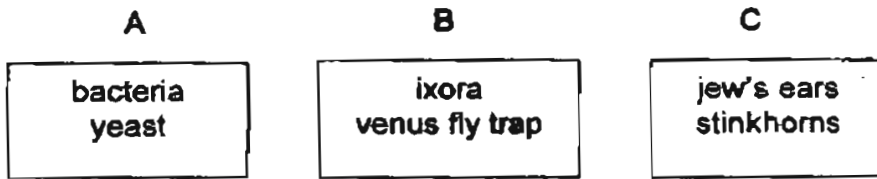

Which of the following did she group them according to?

	A	B	C
(1)	plants	animal	fungi
(2)	animals	fungi	plants
(3)	fungi	animal	micro-organism
(4)	micro-organism	plants	fungi

20. Bala drinks a bottle of Yakult everyday. His mother says that it will help him in digestion. What is found in the drink that helps digestion?

- A Yeast
- B Mould
- C Bacteria

- (1) A only
- (2) C only
- (3) A and B only
- (4) B and C only

21. Look at the diagram below.

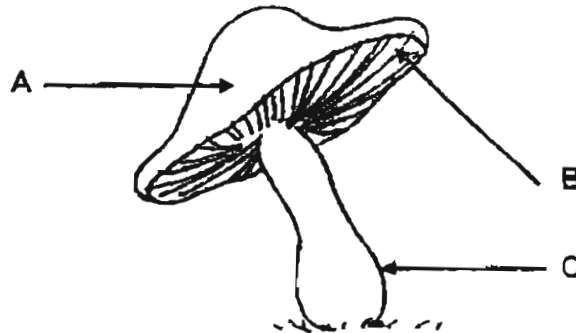

Which of the following correctly labels the parts of the diagrams?

	A	B	C
(1)	Gills	Stalk	Cap
(2)	Stalk	Cap	Gills
(3)	Cap	Gills	Stalk
(4)	Gills	Stalk	Cap

22. Ali was examining a wild mushroom under the microscope. He removed its cap, lay it facing downwards on a black piece of paper. After several hours, Ali removed the cap. There were some white deposits on the paper. What are these white deposits?

- (1) Dirt
- (2) Dust
- (3) Flour
- (4) Spores

23. John was about to eat his bread when he commented, "I love to eat bread because it is soft and fluffy!"

Which one of the following helps makes it possible for the bread to be soft and "fluffy"?

- (1) Moss
- (2) Mould
- (3) Yeast
- (4) Algae

24. Which of the following statement(s) about fungi are incorrect?

- A Spores have the same function as seeds
- B Fungi do not have leaves but have roots
- C Fungi feed on live and dead animals and plants
- D Some mushrooms are green because they have chlorophyll

- (1) A & C only
- (2) B & C only
- (3) B & D only
- (4) D & A only

25. Which of the following materials is most suitable to make a floating toy and does not break easily?

- (1) glass
- (2) plastic
- (3) ceramic
- (4) porcelain

26. Which one of the following pairs is incorrect?

	Material	Origin
(1)	Plastic	Man-made
(2)	Cotton	Animals
(3)	Rubber	Plant
(4)	Rock	From the ground

27. Study the items below.



Picture Frame



Five-cent coin

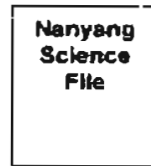

Science File

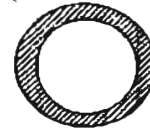

Paper Plate

Based on your observations of the diagrams above only, how would you group them into 2 groups?

- (1) according to their size
- (2) according to their shape
- (3) according to their weight
- (4) according to their material

28. May took 4 objects made of different materials and used a coin to scratch the surface of each object.

She wanted to find out which object is _____.

- (1) man-made
- (2) the hardest
- (3) the strongest
- (4) the most elastic

29. Muthu laid 4 objects on the floor. He used the same amount of strength and hit hard on each object with a hammer once. Which of the following object(s) is/are not likely to break?

- A A mirror
- B A ceramic bowl
- C A piece of paper
- D A porcelain bowl

- (1) B only
- (2) C only
- (3) A and B only
- (4) C and D only

30. In which one of the following diagrams are the materials used to make the items labelled wrongly?

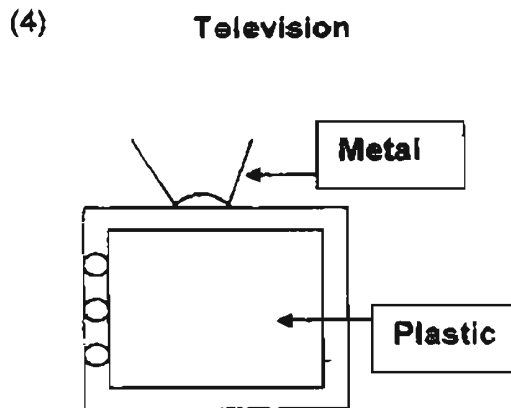
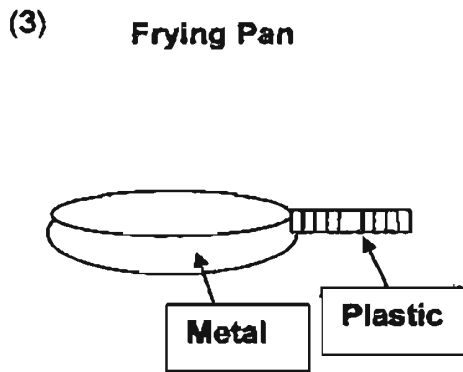
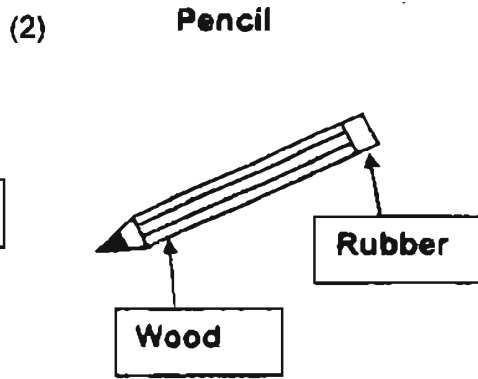
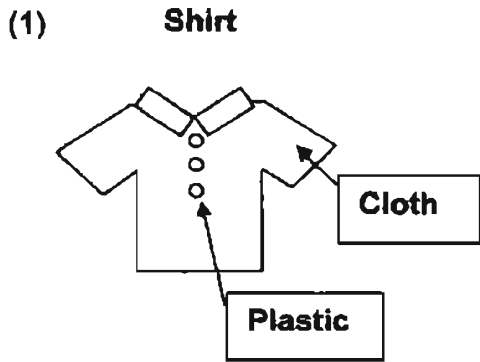

NANYANG PRIMARY SCHOOL

PRIMARY THREE SCIENCE

**SEMESTRAL ASSESSMENT 1
2005**

BOOKLET B

Date : 6TH MAY 2005

Duration : 1 h 45 min

Name : _____ ()

Class: Primary 3 ()

Marks Scored:

Booklet A:	60
Booklet B :	40
Total :	100

Parent's signature:

**DO NOT OPEN THIS BOOKLET UNTIL YOU ARE TOLD TO DO SO.
FOLLOW ALL INSTRUCTIONS CAREFULLY.**

Booklet B consists of 14 printed pages including this cover page.

Section B (40 marks)

Write your answers to questions 31 to 48 in the spaces provided.
Marks will be deducted for misspelt key words.

31. Study the chart below.

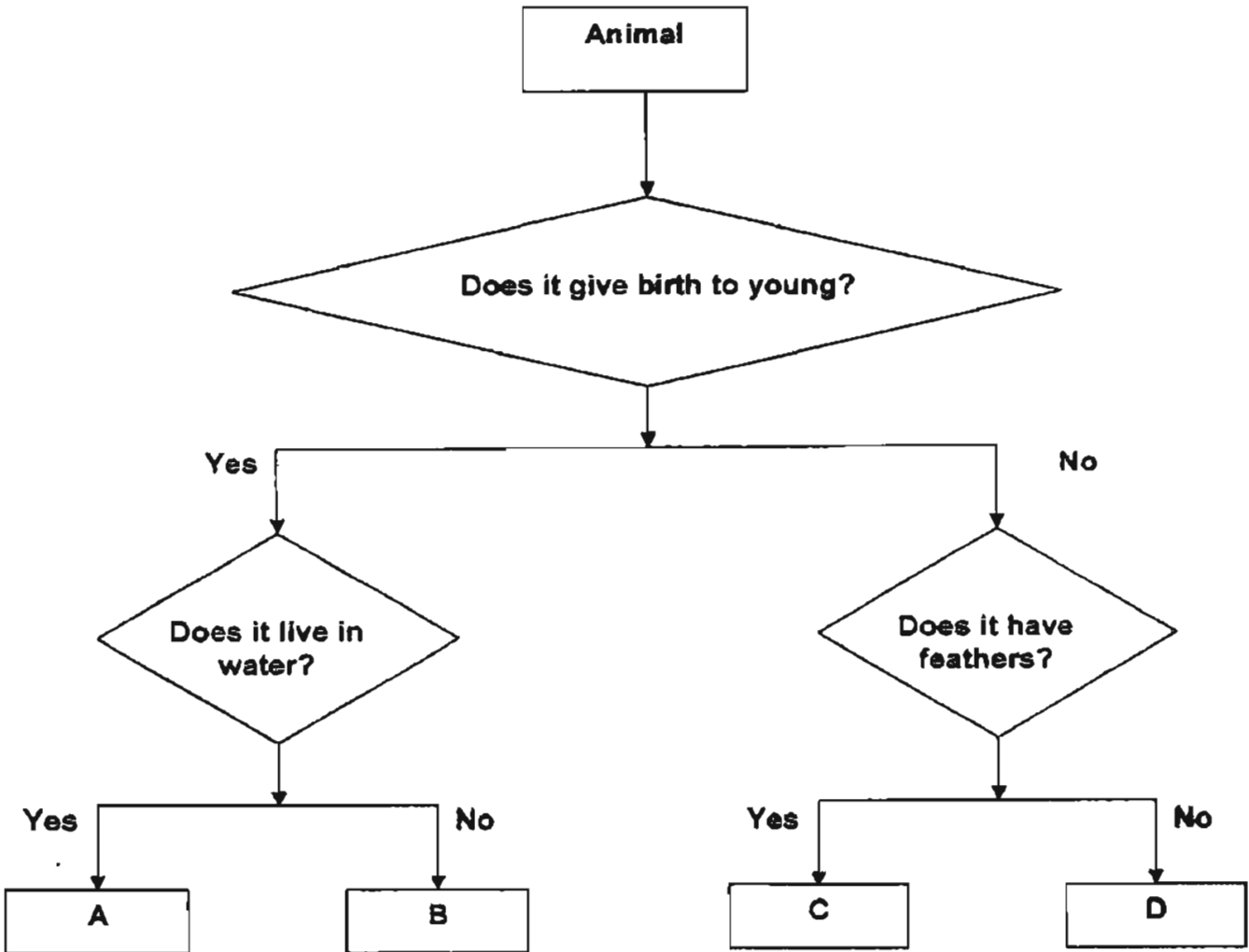

Identify the letters A, B, C and D in the flow chart that represent each of the following animals. (4 marks)

- a) Bat: _____
- b) Guppy: _____
- c) Ostrich: _____
- d) Crocodile: _____

32. On an expedition to a tropical rainforest, Ali saw an animal H that he had never seen before. He then spent a few days in the forest taking notes on the animals characteristics. He noted the following characteristics.

Characteristics

- Its weight.
- Its height.
- The food it eats.
- Its outer covering.
- The number of legs.
- The number of wings.
- How it feeds its young.

Based on the above, he concluded that the animal was a mammal.

- a) Which of the characteristics listed above helped him conclude that animal H was a mammal? (2 marks)

- b) What do you think he would observe in animal H for the characteristics listed in (a)? (1 mark)

33. Peter predicted that caterpillars prefer fresh leaves to dead leaves. In order to prove his prediction, he decided to conduct an experiment. He placed five similar caterpillars into each of the three boxes labelled P, Q and R as shown below. He also placed only dead leaves in P, only fresh leaves in Q and a mixture of dead leaves and fresh leaves in R. Then, he left them in the Science Room. All the boxes were then covered and many small holes were made on the lids.

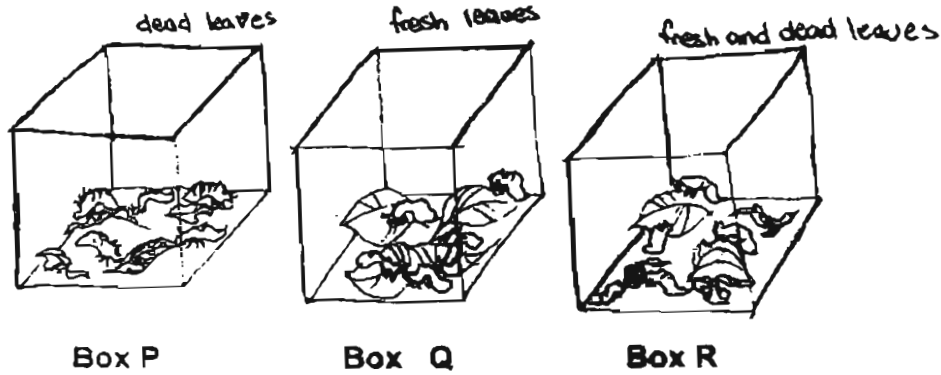

After five hours, he weighed the leaves in each box. The graph below shows the amount of leaves at the beginning and at the end of the experiment for Box P and Q.

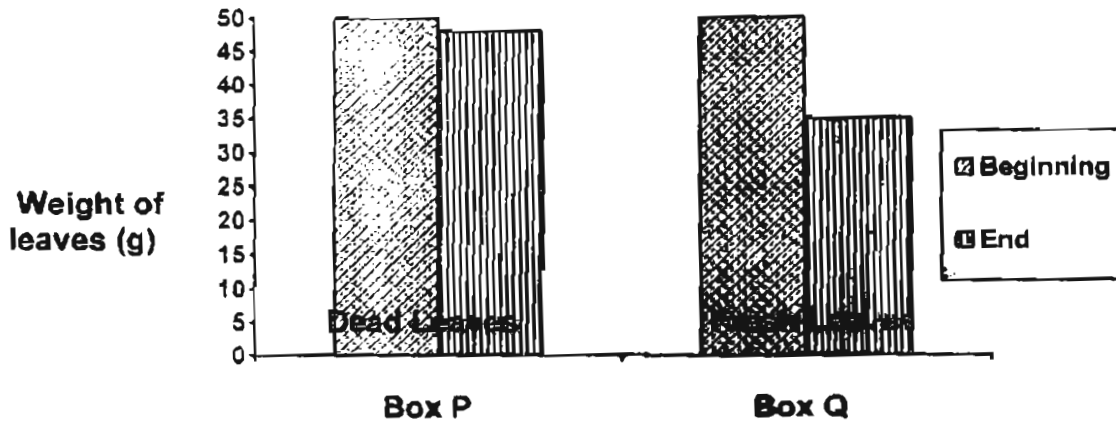

Answer part (i) and (ii) based on the graph above.

i) Was Peter correct in his prediction? (1 mark)

ii) Explain your answer in (i).

(1 mark)

iii) In the diagram below, draw the bars that represent the final weight of the dead and fresh leaves in **Box R**. (2 marks)

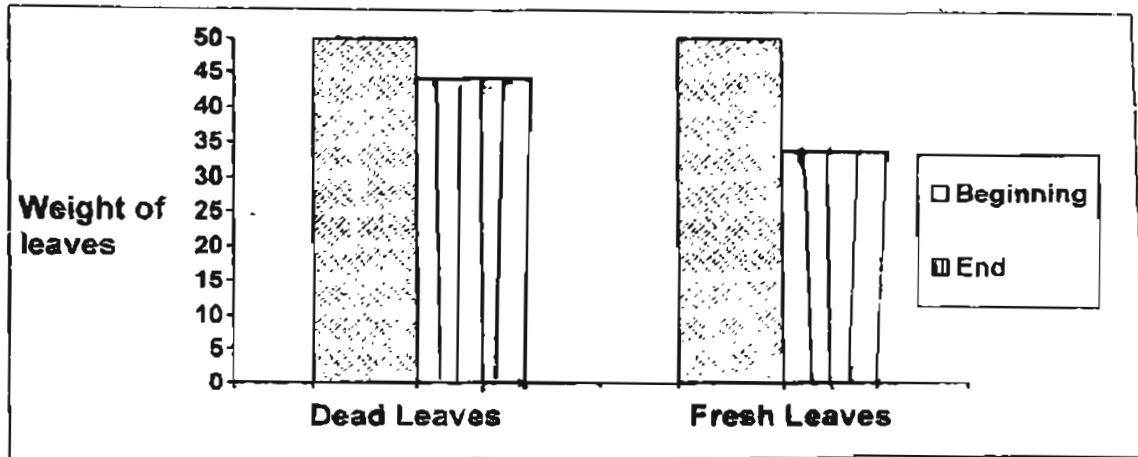

Box R

34. Tom classified some animals into two groups as shown below.

Group M	Group N
Cow	Duck
Whale	Cod
Cat	Dove

He said that platypus could be placed in both Group M and N. State the characteristics for each group. (1 mark)

Group M: _____

Group N: _____

35. Study the fruits, P and Q below.

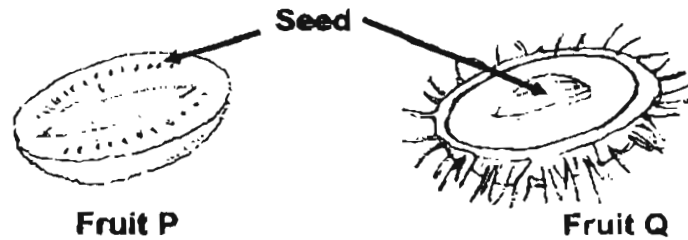

- a) Based only on the diagram above, state 1 common characteristic of both fruits. (1 mark)

- b) Based only on the diagram above, state 1 difference in the characteristic of both fruits. (1 mark)

36. Muthu carried out an experiment using 2 plants, W and X. Both pots of plants of the same size were grown in fertile soil. They were given equal amounts of water daily and placed under the sun. However, he covered both the top and underside of all the leaves of plant W with clear masking tape.

- a) Which plant, W or X, would not survive after 1 week? (1 mark)

- b) Name the condition that was necessary for the plant to make food but was absent in the above experiment. (1 mark)

- c) State a condition that had to be kept the same for the experiment to be a fair test. (1 mark)

37. Terrence drew a picture of his school's garden as shown below. In the garden was a fence (A), a pond (B), a tree (C) and a ploughed strip of land (D).

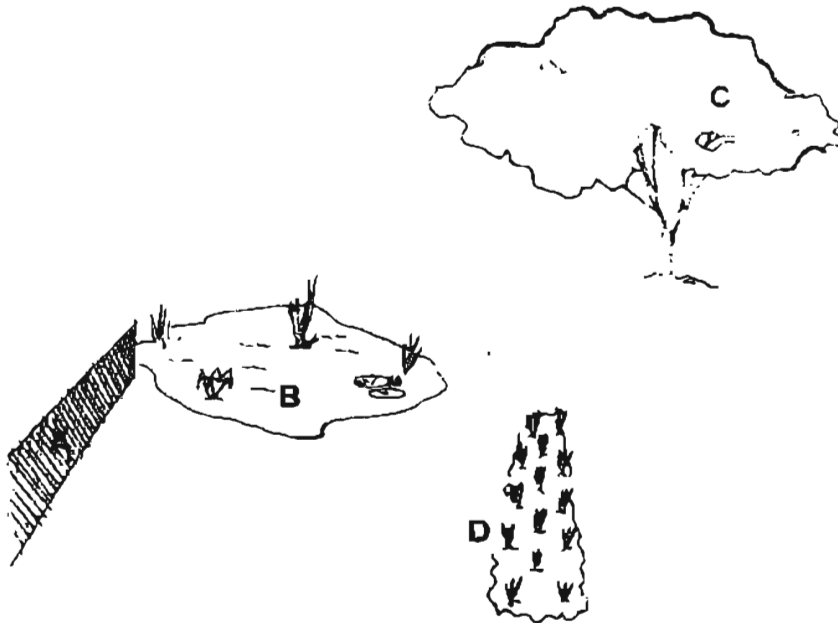

Write the alphabet A, B, C and D that best represents the location that each of the following plants would most likely grow. (2 marks)

- i) morning glory _____
- ii) tape grass _____
- iii) lettuce _____
- iv) stag's horn fern _____

38. Kiran planted 2 different types of plants, Plant A and Plant B, under a tree as shown in the diagram below. Both plants were watered daily with equal amounts of water. After a month, Plant B died but Plant A was still growing well.

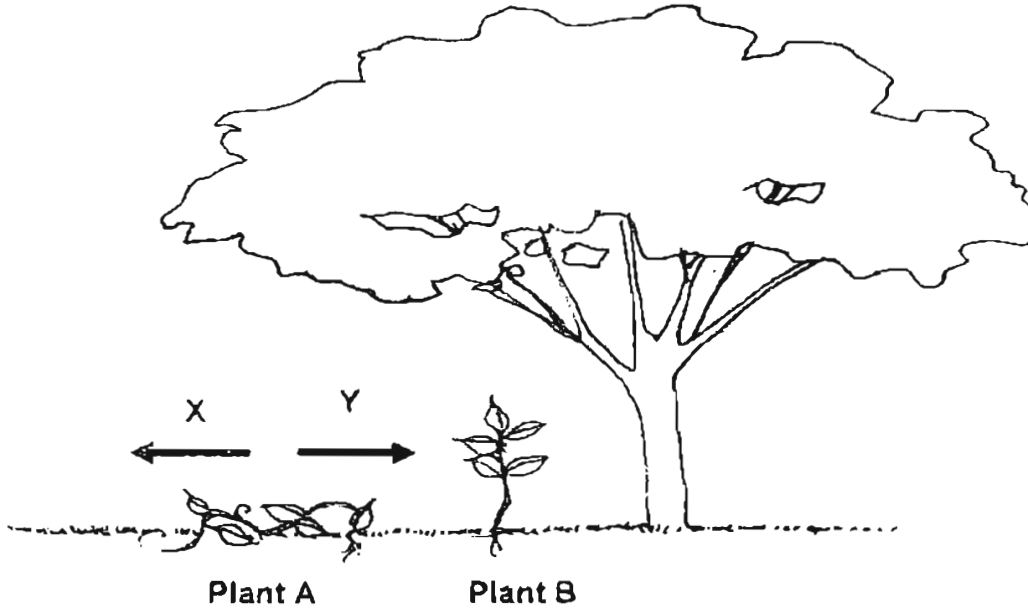

- a) For Plant A to survive, in which direction as shown by arrows X and Y was Plant A growing? (1 mark)

- b) Explain why Plant A was growing in that direction. (1 mark)

39. Ali carried out 2 experiments and the results are shown below.

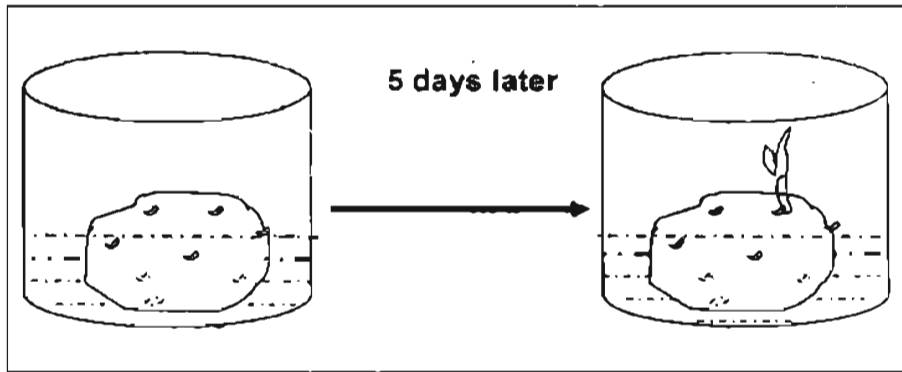

**Experiment 1:
Potato placed in water**

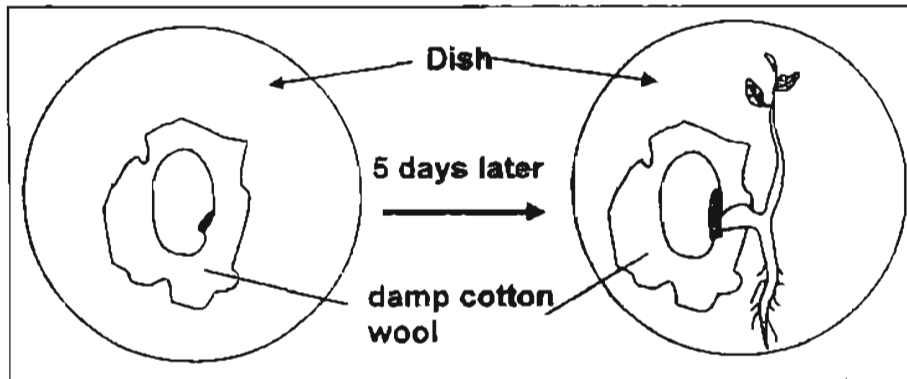

**Experiment 2:
Seed on damp cotton wool**

Ali said, "Both the potato and seed are non-living things. It does not move around to look for food".

a) Based on the results shown in the diagrams above, are seeds and potatoes living or non-living things? (1 mark)

b) Explain your answer in (a) (1 mark)

40. Alvin was given the following items.

Algae	Water
Hair	Ant

He was asked to classify them using the classification chart below.

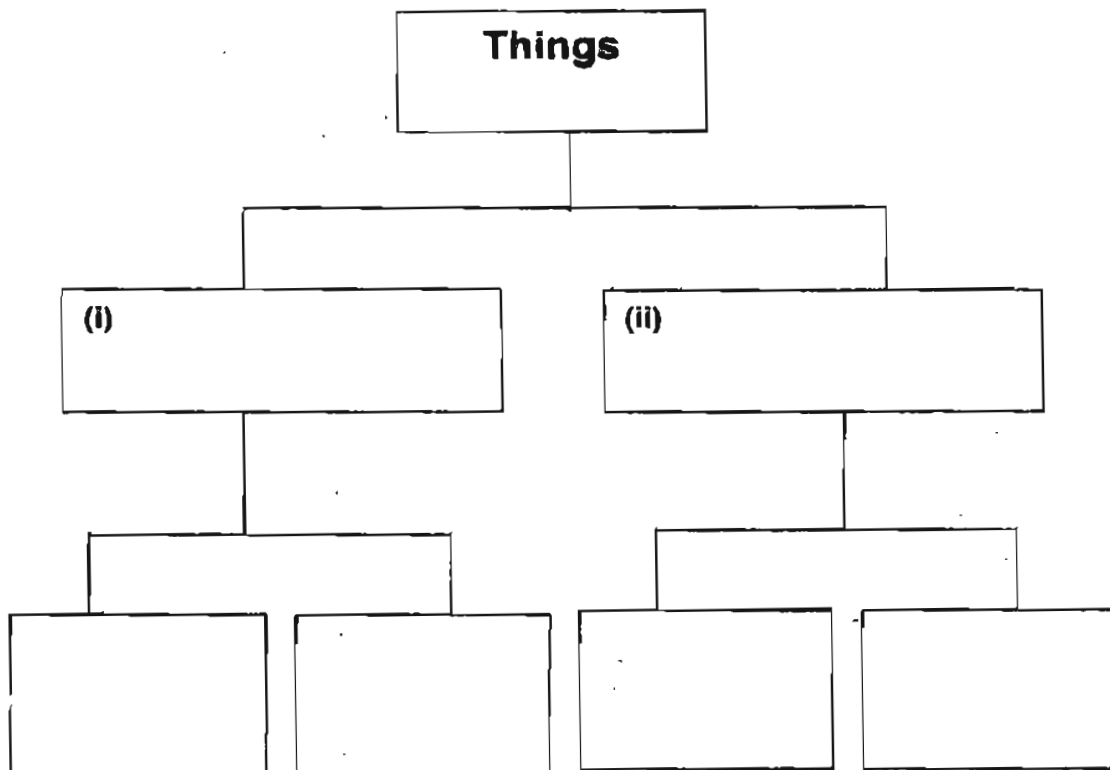

- a) Give a heading in the boxes (i) and (ii) (1 mark)
- b) Group the items that Alvin was given according to your headings in boxes above. (1 mark)

41. Weiming's mother poured a glass of milk for him.
Weiming said, "Cows produce milk that is being drunk by humans. It is amazing that cows can make their own food."

a) Explain why Weiming was not right in saying that cows make their own food. (2 marks)

42. The object below shows a hairdryer.

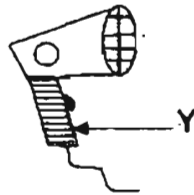

a) Give 2 reasons why metal is not used to make the outer casing of the hairdryer. (2 marks)

b) Why is the handle, marked "Y", made of rubber? (1 mark)

43. May bought a cake and cut 2 equal pieces from it. She then put each piece into 2 transparent containers, A and B. She left container A open but she covered container B with a dark cloth as shown below.

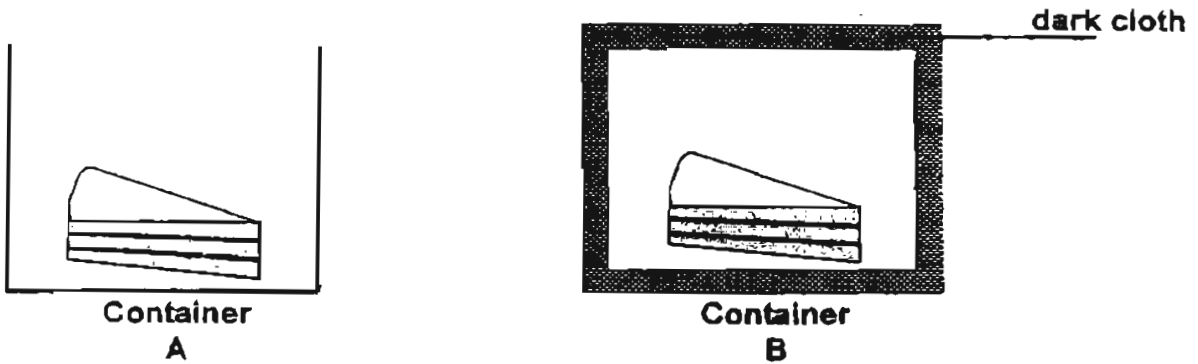

After a week, she observed that there were patches of thread-like things on both pieces of cake. Mother told her that it had gone bad and could not be eaten.

- a) What were the thread-like things they saw? (1 mark)

- b) What was the aim of May's experiment? (1 mark)

May repeated the experiment. This time she used an air tight container. After a week, they realised that there were still white patches but this time they were much smaller.

- c) Explain why the patches were not as large as before. (1 mark)

44. One day, Ben noticed something growing on his skin. As days went by, it did not go away; it was at the same spot and has even started to spread to other parts of his skin! After much thought, he said, "This is definitely a living thing. I'm sure this is a kind of fungus".

a) Name a characteristic of living things that made Ben so sure that it was a living thing. (1 mark)

b) An anti-fungal cream was applied to the spots to dry them up. A few days after applying the cream, the spots were gone. What was the condition for its growth that was absent after the cream was applied? (1 mark)

45. Fill in the blanks with an appropriate word. (2 marks)

Keys are mostly made of _____. The material is used because it is _____, thus can be easily pressed into the shapes needed.

46. The flowchart below describes the characteristics of 4 different materials represented by the letters A, B, C and D.

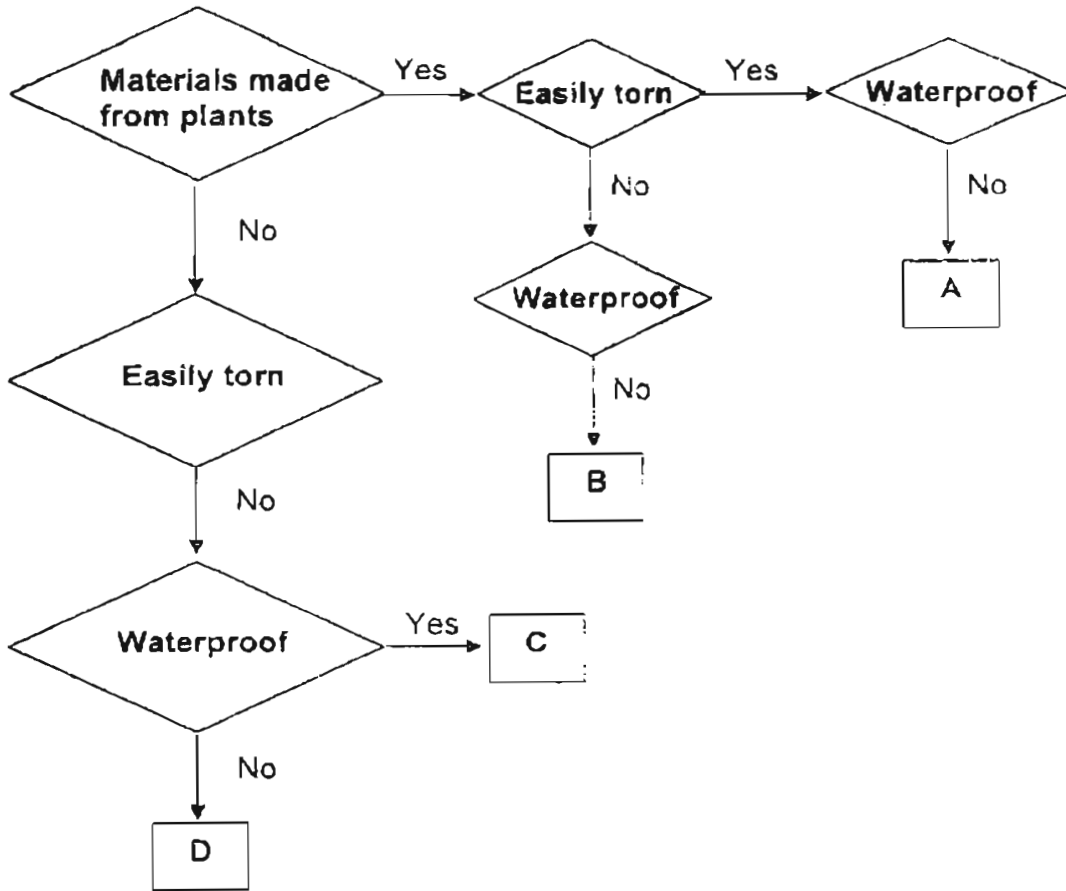

a) Sue wanted to choose a material to make a bag which could carry heavy books and protect them from the rain. Which of the above materials A, B, C or D would she choose? (1 mark)

b) Name the 2 characteristics of the material chosen in part (a). (1 mark)

c) Which letter best represents a newspaper? (1 mark)

Nanyang Primary School
Primary 3 Science SA1 Exams (2005)

Exam Time

Answer Sheets

Q1	Q2	Q3	Q4	Q5	Q6	Q7	Q8	Q9	Q10
4	4	4	2	1	2	4	4	1	3
Q11	Q12	Q13	Q14	Q15	Q16	Q17	Q18	Q19	Q20
3	3	2	1	4	3	1	1	4	2
Q21	Q22	Q23	Q24	Q25	Q26	Q27	Q28	Q29	Q30
3	4	3	3	2	2	2	2	2	4

- 31a. B
 31b. A
 31c. C
 31d. D
- 32a. How it feed it you and its outer covering help him conclude that animal H was a mammal.
- 32b. It has hair and feeds on its young.
33. (i) Yes, Peter was correct.
 (ii) The caterpillars ate more fresh leaves than dead leaves.
34. Group M : Have hair on their bodies
 Group N : Lay eggs.
- 35a. They have hairy outer covering.
 35b. Fruit P has many seeds while Fruit Q has one seed.
- 36a. Plant W will not survive.
 36b. The plant needs carbon dioxide.
 36c. He must use the same type of plants.
37. (i) A
 (ii) B
 (iii) D
 (iv) C

- 38a. Plant A was growing by arrow X.
38b. Plant A needed sunlight to grow.
- 39a. The seeds and potatoes are living things.
39b. They can grow.
- 40.
- 41a. Cows do not have chlorophyll.
- 42a. Metal is a good conductor of heat.
42b. So that heat or electricity cannot get through.
- 43a. The bread like things were bread mould.
43b. May want to know where fungi grow.
43c. That was not enough air for the fungi to grow.
- 44a. Living things reproduce.
45. Metal solid.
- 46a. She would choose C
46b. It is waterproof and not easily torn.
46c. A best represents a newspaper.