

CA2

Tao Nan School  
Primary 3 Science Continual Assessment 2 (2004)

Name : \_\_\_\_\_ ( )

Date 26/08/2004

Class : P3 \_\_\_\_\_

Time: 1 hour

Parent's Signature : \_\_\_\_\_

Marks : \_\_\_\_\_ /50

**Section A (36 marks)**

For each question, choose the most suitable answer and write its number in the brackets provided.

1. Which of the following is made mainly from a natural material?

- (1) Rubber tyre
- (2) Plastic bottle
- (3) Styrofoam box
- (4) Pencil sharpener

( )

2. Which is the best material for making a raincoat?

- (1) silk
- (2) wool
- (3) plastic
- (4) cotton

( )

3. Which of the following does not belong to the same group as the rest?

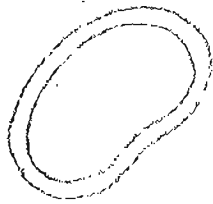

Elastic band  
(1)

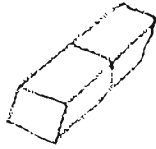

Eraser  
(2)



Balloon  
(3)



straw  
(4)

( )

4. Which of the following objects will float on water?

(1)



cork

(2)



platinum ring

~~3~~

(4)



needle



soap

( )

5. The table below shows some materials classified under 3 different groups.

Group X	Group Y	Group Z
Rubber	Leather	Glass
Wood	Silk	Rock
Flour	ivory	Metal
W		

'W' is classified under group X. Which of the materials is 'W'?

- (1) Cotton (2) Wool  
(3) Clay (4) Iron

6. Some animals have a 3-stage life cycle as shown below.

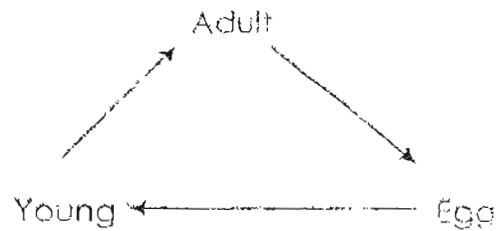

Which of the following animals have this life cycle?

- A: Butterfly  
B: Cockroach  
C: Chicken  
D: Mosquito

- (1) A and B only (2) B and C only  
(3) A, B and C only (4) B, C and D only

7. How are the butterfly and the mosquito alike?

- A: They lay eggs on land.
- B: Their larvae live in water.
- C: They have a 4 stage life cycle.

- (1) A only
- (2) B only
- (3) C only
- (4) A and B only

8. The diagram below shows a fertilized hen's egg. Which part of the egg provides food for the developing chick?

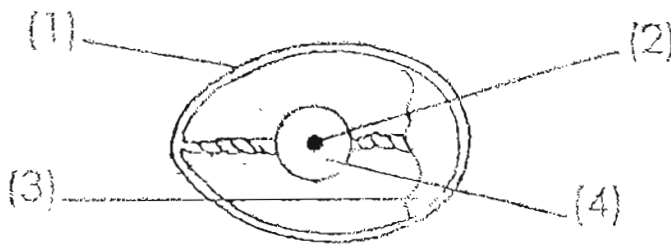

9. Animal X lays an egg. The egg hatches into a larva. The larva spins a cocoon after sometime. Then an adult animal X emerges from the cocoon. Which diagram below shows the life cycle of animal X?

(1)

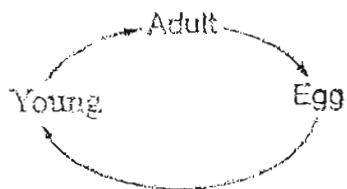

(2)

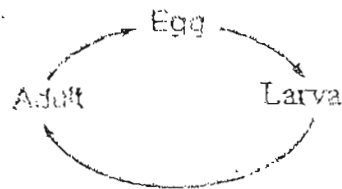

(3)

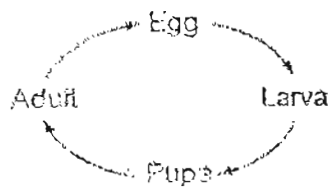

(4)

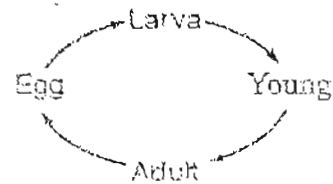

10. The first stage in the development of a bean seed is \_\_\_\_\_.

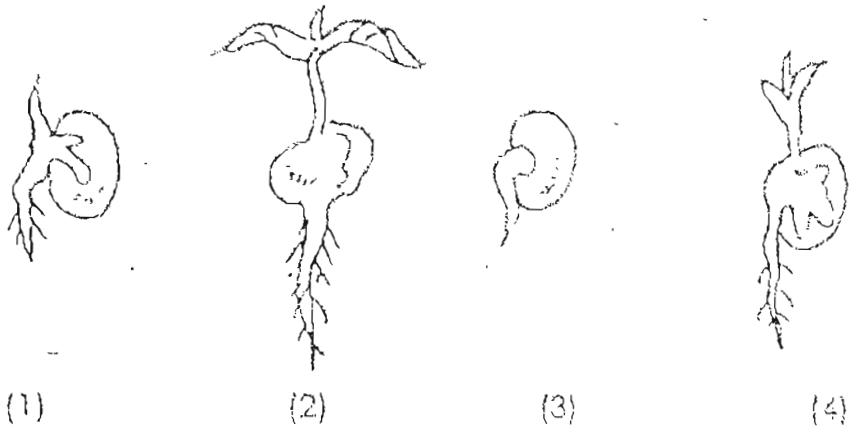

11. Refer to the diagram of the seedling below. What grows towards water?

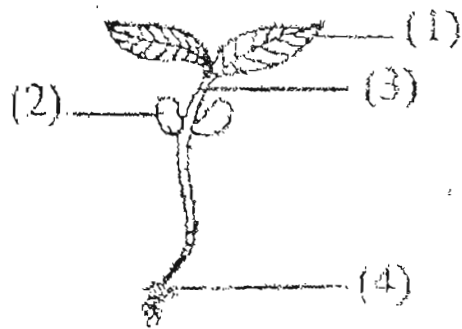

12.

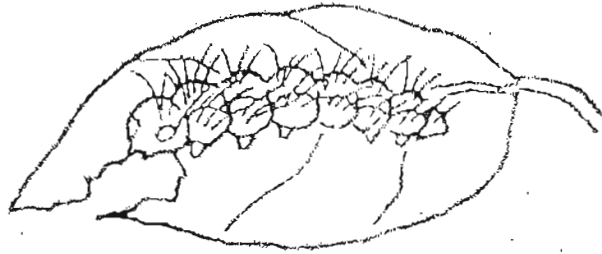

Which of the following shows the next stage in the life cycle of the animal above ?

(1)



Butterfly

(2)



Butterfly pupa

(3)



Mosquito Pupa

(4)



Mosquito

13. Michael has a magnet, a thumbtack and an object X.

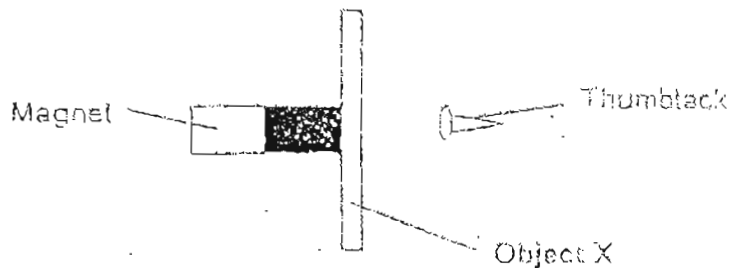

He held onto the thumbtack and placed object X between the magnet and the thumbtack as shown above. What should object X be made of so that the thumbtack will move towards the magnet when released?

- A: Glass
- B: Iron
- C: Steel
- D: Plastic

- (1) A and B only
- (2) A and D only
- (3) B and C only
- (4) C and D only

14. What will happen to the piece of nickel when the magnet is brought near it?

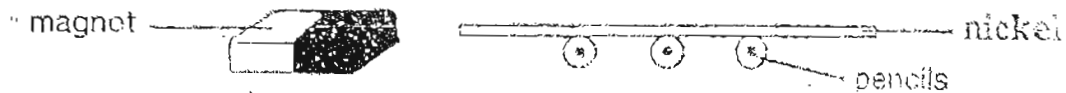

- (1) It will move away from the magnet.
- (2) It will move towards the magnet.
- (3) It will move towards and then away from the magnet.
- (4) It will not move at all.

15. Look at the 2 magnets, X and Y, below.

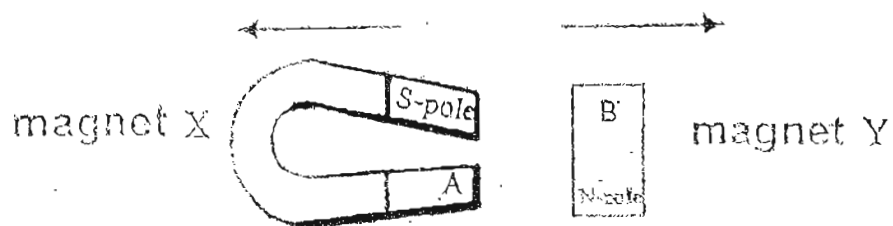

The 2 magnets repel each other. What are the likely poles of 'A' and 'B'?

	Pole A	Pole B
(1)	N-pole	N-pole
(2)	N-pole	S-pole
(3)	S-pole	N-pole
(4)	S-pole	S-pole

16. Which of the following arrangements will cause the three magnets to push one another away?

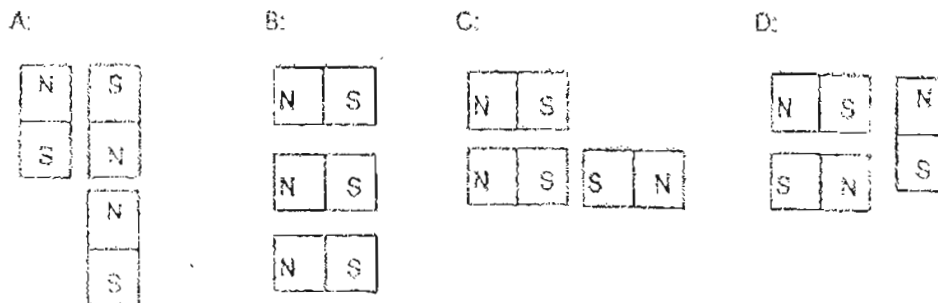

- (1) A and B only
- (2) A and D only
- (3) B and C only
- (4) C and D only



17. Henry wanted to find out whether the number of turns of a wire affect the strength of an electromagnet. Which two experimental set-ups should he choose to carry out the experiment?

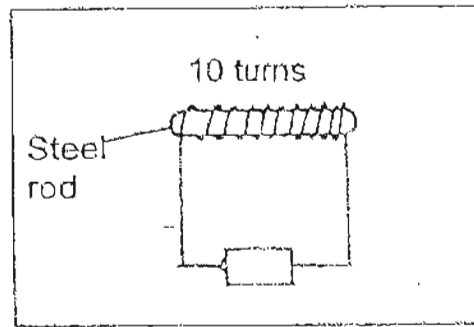

A

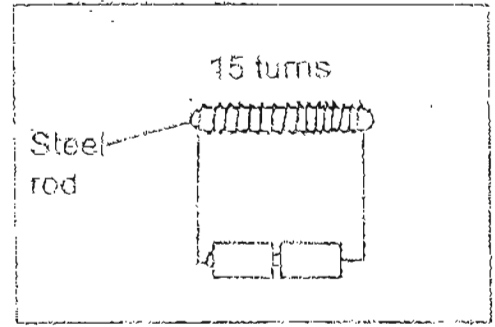

B

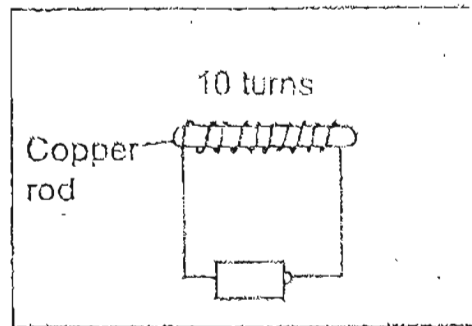

C

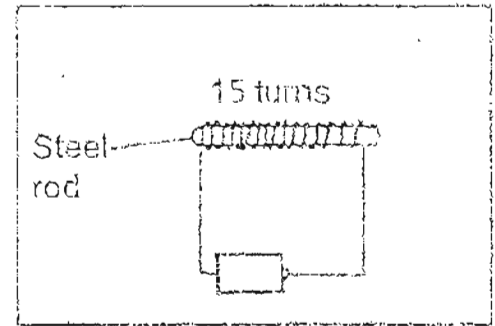

D

- (1) A and B only  
(3) B and C only

- (2) A and D only  
(4) C and D only

{      }

18. An iron nail can be made into an electromagnet when electricity flows around it as shown in the diagram below.

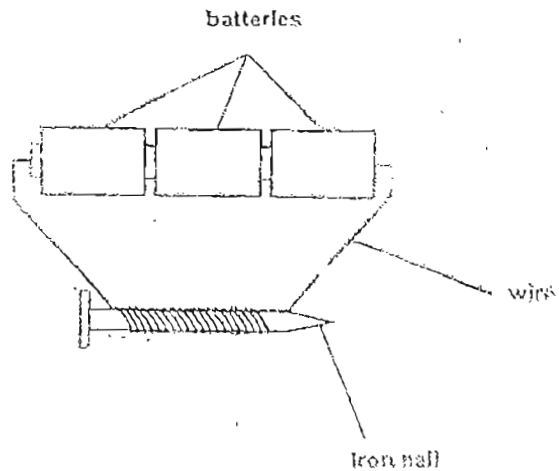

In order for the iron nail to attract more pins, we could \_\_\_\_\_.

- A: use a longer wire
- B: increase the number of batteries
- C: use a longer nail
- D: increase the number of coils of the wire

- (1) A and B only
- (2) A and C only
- (3) B and D only
- (4) C and D only

( )

Section B (14 marks)

Write your answers in the blanks provided.

19. Write true or false in the boxes provided. (2m)

	True/False
a. A seed will grow into a seedling with suitable conditions	
b. A seedling will bear flowers and fruits.	
c. A cockroach nymph moults only once.	
d. The young of cockroaches, butterflies and moths look like their parents.	

20. Arrange these materials according to their hardness (from softest to hardest). (2m)

Brick      Cork      Wood      Metal

Softest

Hardest

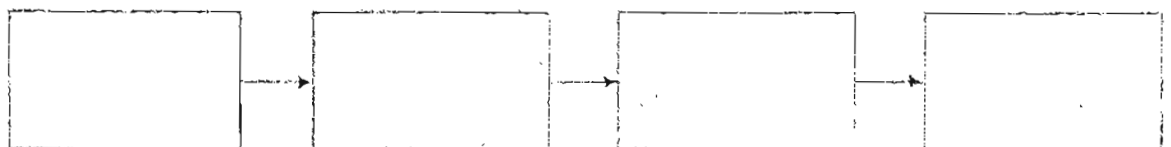

21. John placed three sheets of different materials over the mouths of three containers. He then poured a spoonful of water onto each material. This was what he observed.

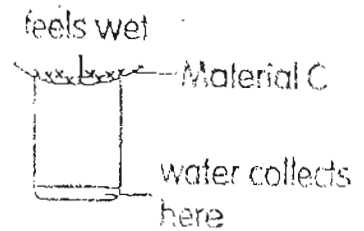
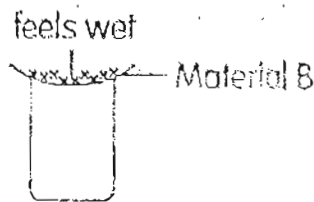
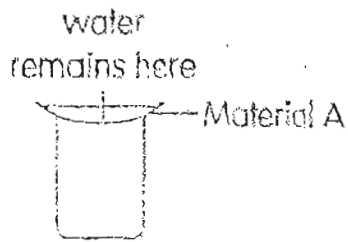

(a) Rank the materials according to the amount of water each can absorb. (1m)

Absorbs the greatest amount of water.

Absorbs the least amount of water.

(b) From the above results, which of the three materials is the best for wiping puddles of water on the floor? Why? (1m)

---

---

22. An iron rod can be made into a magnet by stroking it with a permanent magnet. Label the N-pole and S-pole in the boxes provided. (1m)

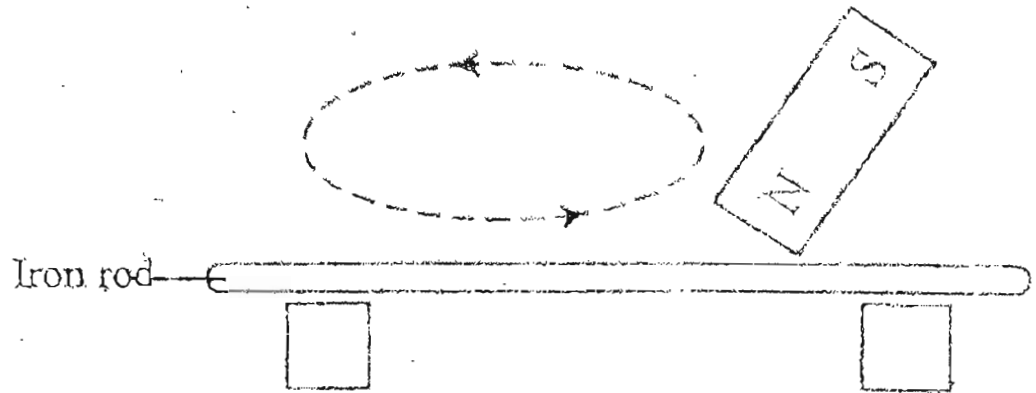

23. Study the pictures of a family of rabbits shown below.

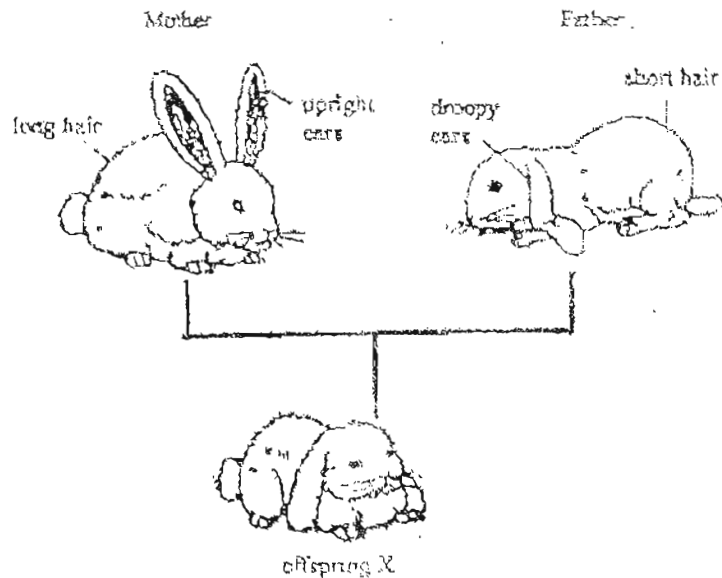

Name one characteristic that offspring X has inherited from its father (1m)

---

24. The diagram below shows the different stages of growth of a seed.

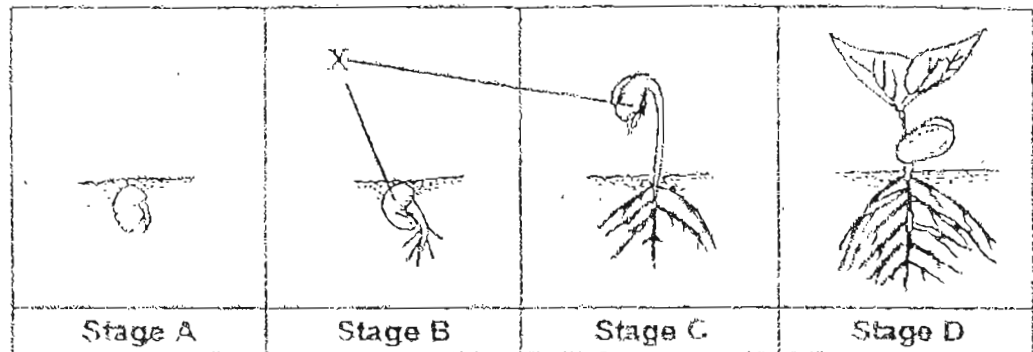

(a) Besides air, what are the other conditions needed for the seed to germinate? (1m)

\_\_\_\_\_

(b) Name the parts marked X. (1m)

\_\_\_\_\_

(c) What is the function of the parts marked X? (1m)

\_\_\_\_\_

(d) At which stage can the seedling make its own food? (1m)

\_\_\_\_\_

25. The diagram below shows three floating ring magnets. In order to make this happen, the magnets must be arranged in a certain way. Write either 'N-pole' or 'S-pole' in the blanks provided. (2m)

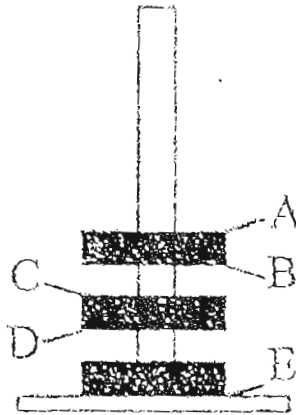

- (i) A: \_\_\_\_\_
- (ii) B: \_\_\_\_\_
- (iii) C: \_\_\_\_\_
- (iv) D: \_\_\_\_\_
- (v) E: N-pole

End of paper

TAO NAN SCHOOL  
PRIMARY 3  
SCIENCE  
CONTINUAL ASSESSMENT 2 (2004)

042-

- 1) 1
- 2) 3
- 3) 4
- 4) 1
- 5) 1
- 6) 2
- 7) 3
- 8) 4
- 9) 3
- 10) 3
- 11) 4
- 12) 2
- 13) 2
- 14) 2
- 15) 2
- 16) 3
- 17) 2
- 18) 3
- 19) a) True
  - b) False
  - c) False
  - d) False
- 20) Cork Wood Metal Brick
- 21) a) B
  - C
  - A
  - b) Material B. It absorbs the most amount of water.
- 22) N S
- 23) It has inherited his droopy ears from its father.
- 24) a) It also needs warmth and water.
  - b) Seedleaves
  - c) It gives the plant food.
  - d) Stage D
- 25) i) South-pole
  - ii) North-pole
  - iii) N-pole
  - iv) S-pole