

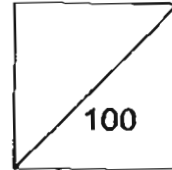

HENRY PARK PRIMARY SCHOOL  
2011 SEMESTRAL EXAMINATION 2  
MATHEMATICS  
PRIMARY 3



Name: \_\_\_\_\_ ( )

Parent's Signature

Class: Pr 3 \_\_\_\_\_

Duration of Paper: 1 h 30 min

---

**Section A: (20 x 2 marks = 40 marks)**

Choose the correct answer and write its number in the brackets provided.

You are required to shade the OAS at the end of the examination.

1. In 5083, the value of the digit 8 is \_\_\_\_\_.

- (1) 8
- (2) 80
- (3) 800
- (4) 8000

( )

2. Which one of the following statements is true?

- (1)  $7 \times 7 = 50$
- (2)  $12 \times 4 = 48$
- (3)  $36 \div 6 = 5$
- (4)  $81 \div 9 = 8$

( )

3. What is the length of the bold line from A to B as shown below?

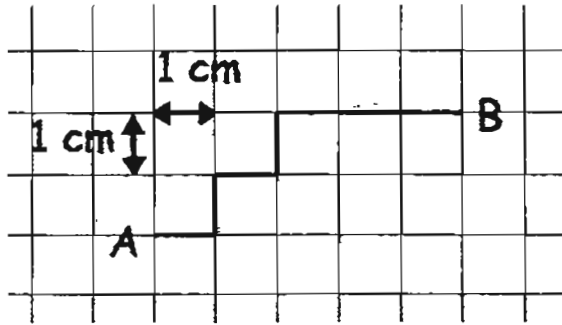

- (1) 7 cm
- (2) 6 cm
- (3) 5 cm
- (4) 4 cm

( )

4. What is the mass of the fish as shown in the diagram below?

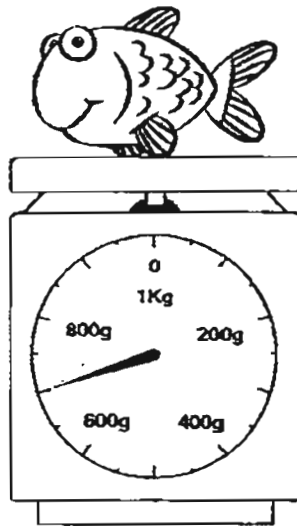

- (1) 600 g
- (2) 650 g
- (3) 700 g
- (4) 1400 g

( )

5. What is the total volume of water shown in the two beakers below?

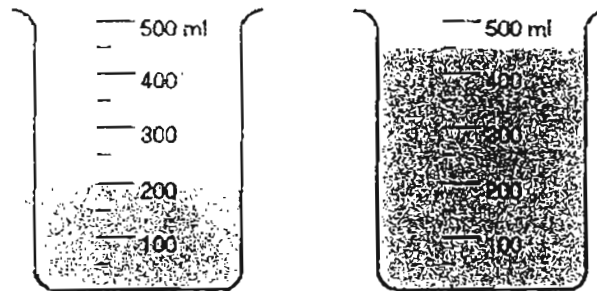

- (1) 200 ml
- (2) 450 ml
- (3) 600 ml
- (4) 650 ml

( )

6.  $\frac{3}{6} - \frac{1}{3} = \square$

- (1)  $\frac{1}{6}$
- (2)  $\frac{2}{3}$
- (3)  $\frac{2}{6}$
- (4)  $\frac{5}{6}$

( )

7. A square has a length of 7 cm. What is the perimeter of the square?

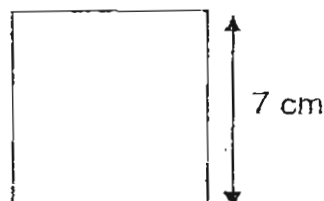

- (1) 14 cm
- (2) 21 cm
- (3) 28 cm
- (4) 49 cm

( )

8.  $7300 + 9 \text{ hundreds} + 3 \text{ tens} = \underline{\hspace{2cm}}$

In the answer obtained above, which digit is in the thousands place?

- (1) 7
- (2) 2
- (3) 3
- (4) 8

( )

9. Damien used some grey and white beads to form the pattern shown below. He placed a box over some grey beads to cover them. How many grey beads did he cover with the box?

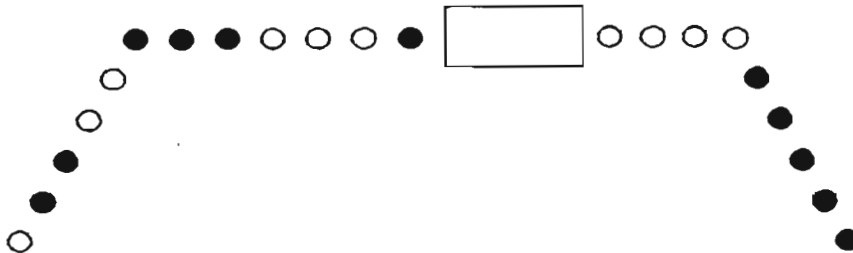

- (1) 5
- (2) 2
- (3) 3
- (4) 4

( )

10. Find the missing number in the box.

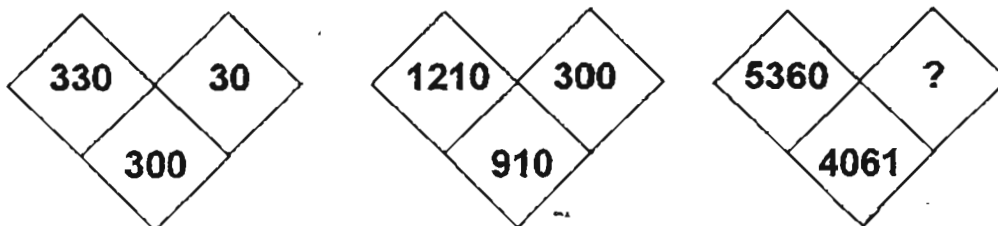

- (1) 1299
- (2) 1399
- (3) 9321
- (4) 9421

( )

11.  $423 \times 7 = \square - 39$

What is the missing number in the box?

- (1) 2900
- (2) 2922
- (3) 2961
- (4) 3000

( )

12. A chair costs \$15 more than a stool. The chair costs \$50.

How much must Ali pay when he buys 10 stools?

- (1) \$350
- (2) \$450
- (3) \$550
- (4) \$650

( )

13. Kim swam for 25 minutes. She finished her swim at 9.35 a.m. .

She started swimming at \_\_\_\_\_ .

- (1) 9.00 a.m.
- (2) 9.10 a.m.
- (3) 10.00 a.m.
- (4) 10.10 a.m.

( )

14. The table below shows the distance cycled by 3 girls over two days.

	Ashley	Betty	Cindy
Distance cycled on Day 1	1 km 5 m	1 km 50 m	1500 m
Distance cycled on Day 2	1 km 5 m	2000 m	1 km 750 m

After 2 days, who cycled more than 3000 m?

- (1) Ashley
- (2) Betty
- (3) Ashley and Betty
- (4) Betty and Cindy

(     )

15. A bottle is 300 g heavier than a book.

The total mass of the bottle and the book is 1300 g.

What is the mass of the book?

- (1) 500 g
- (2) 650 g
- (3) 800 g
- (4) 1000 g

(     )

16. The given figure is made up of 8 identical squares. What fraction of figure is shaded?

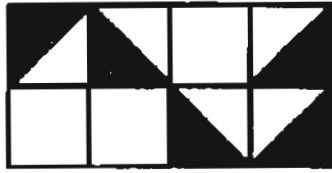

(1)  $\frac{5}{8}$

(2)  $\frac{5}{11}$

(3)  $\frac{5}{13}$

(4)  $\frac{5}{16}$

( )

17. The figures below are drawn to scale. Which of the figures has only 1 pair of perpendicular lines?

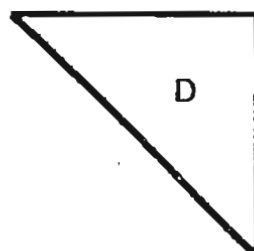
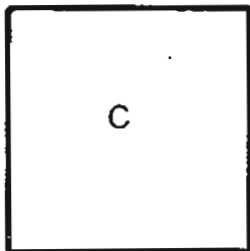
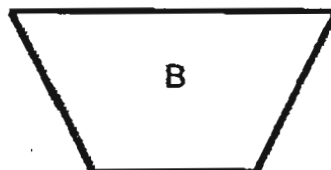

- (1) A  
 (2) B  
 (3) C  
 (4) D

( )

18. The figure below is made up of a rectangle and a square. What is the perimeter of the figure?

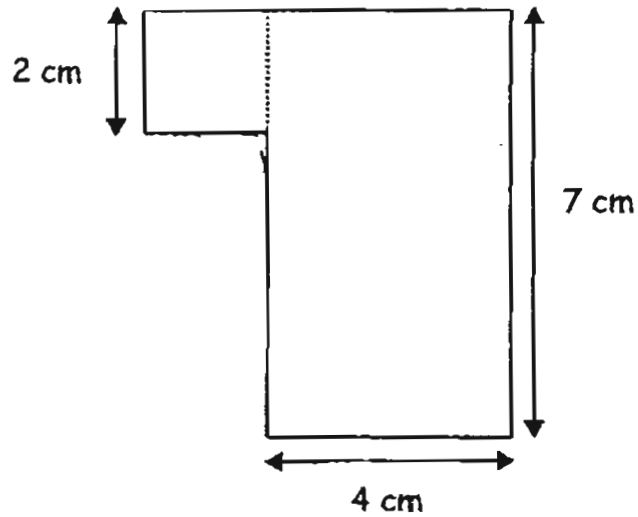

- (1) 13 cm
- (2) 26 cm
- (3) 28 cm
- (4) 32 cm

( )

19. Look at the figure below.

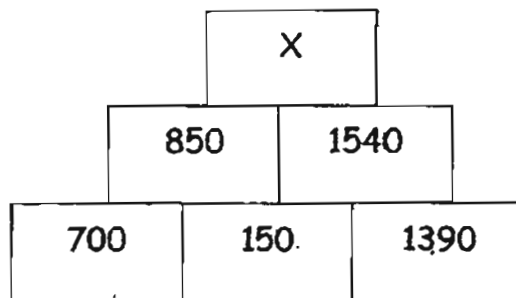

What is the value of X ?

- (1) 1000
- (2) 1390
- (3) 2300
- (4) 2390

( )



20. There was some water in a jar at first. When 1000 ml of water was poured into it, 300 ml of water flowed out of the jar.

The capacity of the jar was 800 ml.

How much water was in the jar at first?

- (1) 100 ml
- (2) 200 ml
- (3) 500 ml
- (4) 700 ml

(     )

**Section B: Open-Ended (20 x 2 marks = 40 marks)**

Read the following questions carefully and write your answers in the boxes provided. Show all your workings clearly.

21. Find the quotient and remainder.

$$614 \div 7 = \underline{\quad\quad} \text{ R } \underline{\quad\quad}$$

R
---

22. Mr Tan paid \$1535.00 for a guitar and \$ 2346.50 for a laptop. How much did Mr Tan pay altogether for the two items?

\$
----

23. Express 2095 g in kilograms and grams.

kg	g
----	---

24. Work out the question below. Write your answer in its simplest form.

$$\frac{6}{8} - \frac{2}{4} = \boxed{?}$$

25. The figure below is made of straight lines. Name a pair of parallel lines in the figure.

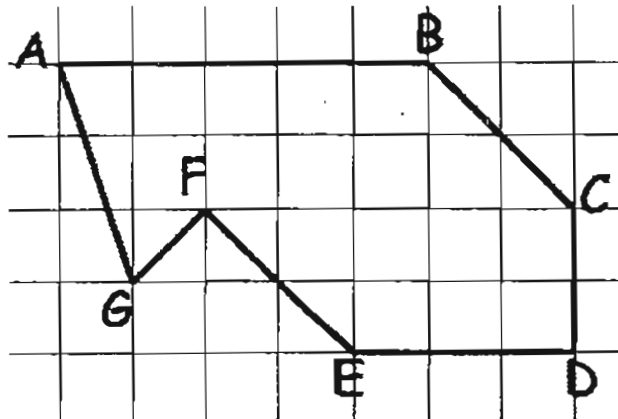

26. Arrange the fractions in order. Begin with the smallest.

$$\frac{4}{6}, \frac{3}{4}, \frac{7}{12}$$

27. The table below shows the number of marbles John collected over 4 days. Based on the pattern, find out the number of marbles he will collect on Day 5 and Day 8.

Day	Day 1	Day 2	Day 3	Day 4	Day 5	...	Day 8
Number of marbles collected	15	24	33	42	A	...	B

A =

B =

28. 3 identical comic books cost as much as 5 identical pens. 1 comic book costs \$15. Find the cost of 1 pen.

\$

29. Sarah left her school at 4.10 p.m. She took 40 minutes to travel home. She spent 30 minutes showering immediately after she reached home. What time did she finish showering?

p.m.
------

30. A bridge is 3 km 180 m long. John and his workers painted 890 m of the bridge in the first month. In the second month, they painted another 934 m. What is the length of the bridge that is not painted? Leave your answer in metres.

m
---

31. Tom had some orange juice. He drank 500 ml of it and poured the rest equally into four empty cups. Each cup now had 280 ml of orange juice. What was the volume of orange juice Tom had at first?

ml
----

32. Khadijah has 2680 beads and Mei Qi has 1600 beads. How many more beads must the girls collect to fill a jar with 6000 beads?

--

The following bar graph shows the number of pens sold by a bookstore from Monday to Friday this week. Study the graph carefully and answer questions 33 and 34.

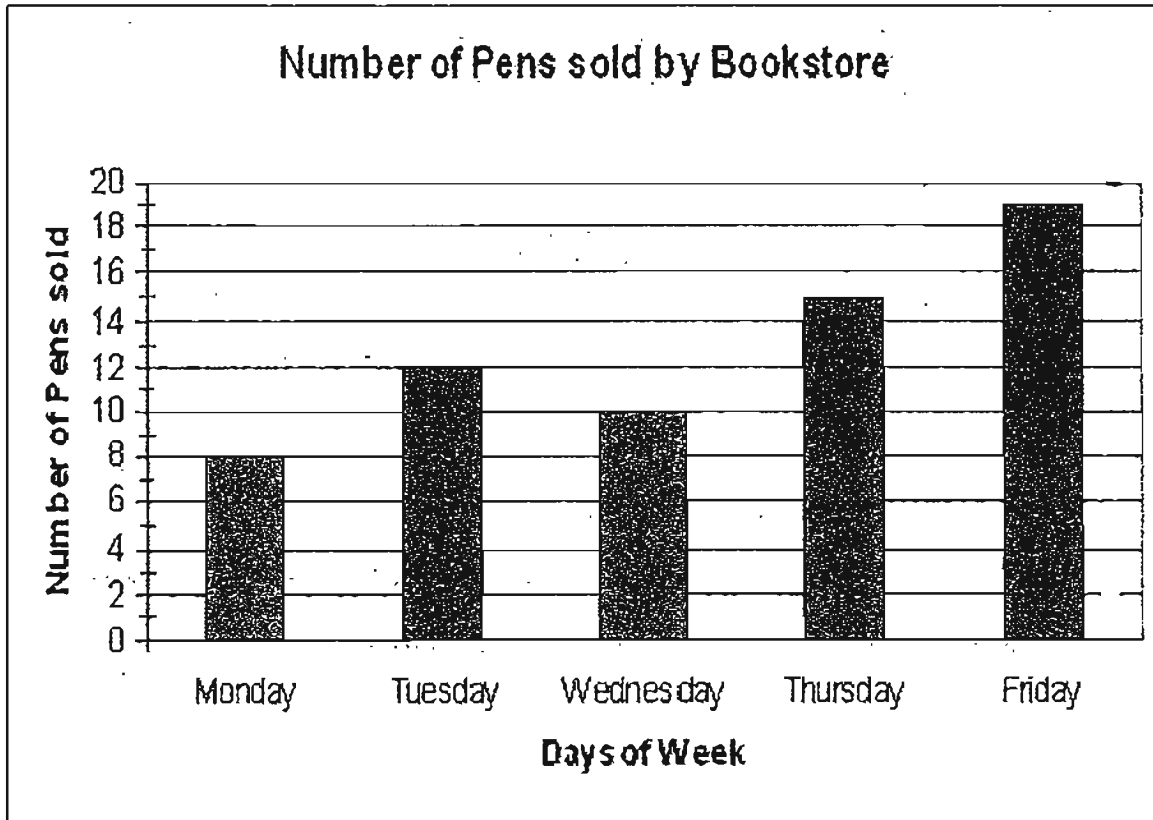

33. How many more pens were sold on Friday than on Wednesday?

34. How many pens did the bookstore sell in total from Monday to Friday?

35. How many angles inside the shaded figure shown below are greater than a right angle?

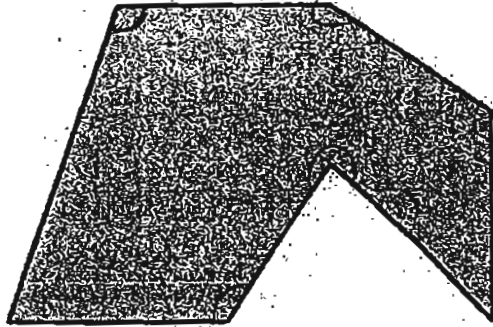

36. Farmer Andy and Farmer Bob had 192 cows altogether.  
After Farmer Andy gave 20 cows to Farmer Bob, Farmer Andy had 3 times  
as many cows as Farmer Bob. How many cows did Farmer Bob have at first?



37. A dental clinic opens everyday for the times shown in the table below.

Opening Hours
8.30 a.m. to 1.00 p.m.
3.00 p.m to 6.00 p.m.

How many hours and minutes is the clinic open each day?

h	min
---	-----

38. Mr Moorthy drew a line measuring 245 cm long on a wall. His son, Ganesh, drew another line which was 180 cm longer on the same wall. What is the total length of the two lines on the wall?

cm
----

39. Alex, Bala and Chang shared a pizza. Alex ate  $\frac{1}{4}$  of the pizza and Bala ate  $\frac{2}{3}$  of the pizza. Chang ate the rest of the pizza. What fraction of the pizza was eaten by Chang? Write your answer in its simplest form.



40. Square A has the same perimeter as Rectangle B.

What is the area of Square A?

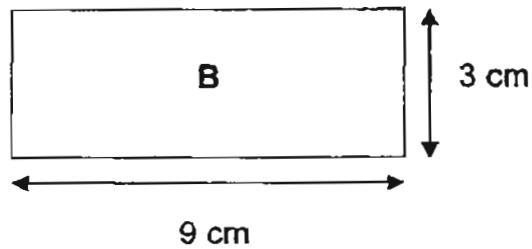
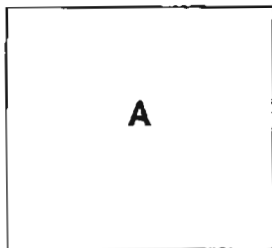

Section C: Problem Sums (5 x 4 marks = 20 marks)

Read the problem sums carefully before solving it.  
Show all your workings clearly.

41. Sara collected 2269 shells on Monday and 1368 shells on Tuesday. She found that some of her shells were chipped and threw them away. If the total number of shells left is 3541, how many shells did she throw away?

Working

42. Stephanie put 248 stickers equally into 8 containers. She gave 6 containers of stickers to Jean. How many stickers did Jean receive?

Working

43. Mrs Koh went shopping with \$700. She spent \$280 on a camera and \$186 on a watch. She then bought a bag and had \$178 left. How much did the bag cost?

Working

44. Alice had 4570 more marbles than Charlie. Belinda had three times as many marbles as Charlie. The three children had 5200 marbles altogether. How many marbles did Belinda have?

Working

45. The rectangle  $ABCD$  shown below is made up of 8 identical rectangles.

It has a total area of  $128 \text{ cm}^2$ . What is the perimeter of the rectangle  $ABCD$ ?

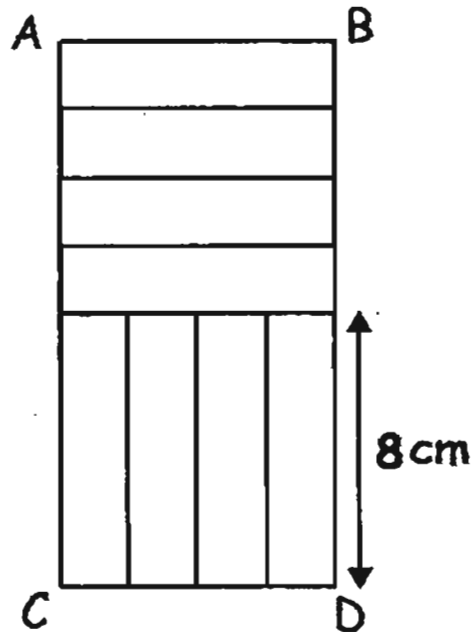

Working

---

- END OF PAPER -

Setters: Mdm. Nadia Abu Bakar

Mr. Tseng Lin Fang

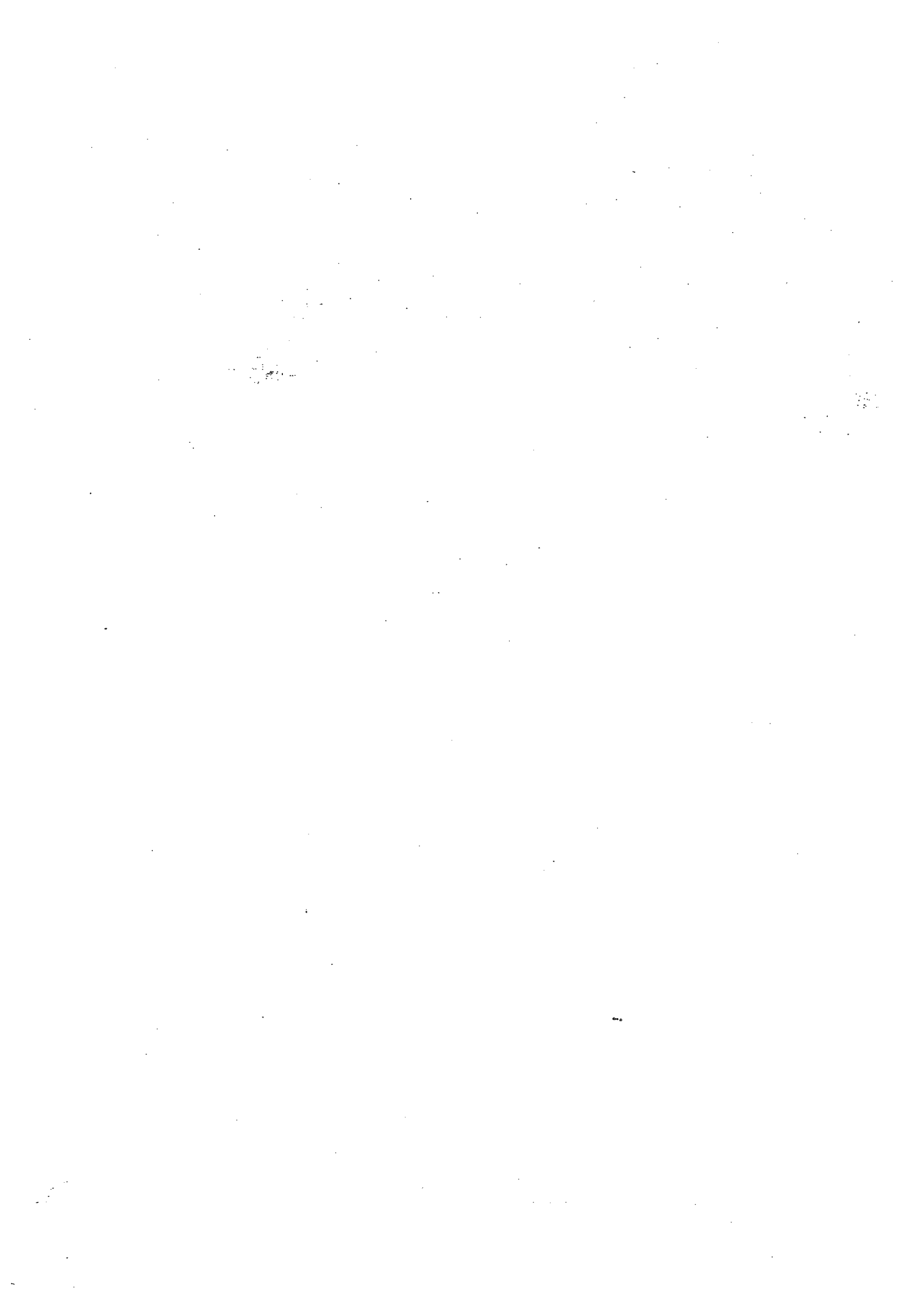

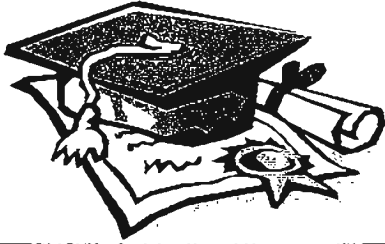

# ANSWER SHEET

## EXAM PAPER 2011

SCHOOL : HENRY PARK  
SUBJECT : PRIMARY 3 MATHEMATICS

TERM : SA2

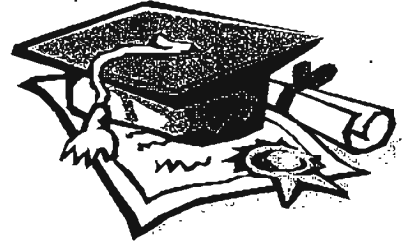

Q1	Q2	Q3	Q4	Q5	Q6	Q7	Q8	Q9	Q10	Q11	Q12	Q13	Q14	Q15	Q16	Q17
2	2	1	3	4	1	3	4	3	1	4	1	2	4	1	4	4

Q18	Q19	Q20
2	4	1

- 21) 87 R 5      22) \$3881.50      23) 2kg 95g      24)  $\frac{1}{4}$       25) AB//DE
- 26)  $\frac{7}{12}$ ,  $\frac{4}{6}$ ,  $\frac{3}{4}$       27) A = 51      B = 78      28) \$9      29) 5.20p.m.
- 30) 1356m      31) 1620ml      32) 1720      33) 9      34) 64
- 35) 5      36) 28      37) 7h 30min      38) 670cm      39)  $\frac{1}{12}$       40) 36cm<sup>2</sup>

41)  $2269 = 1368 = 3637$   
 $3637 - 3541 = 96$   
96 seashells were thrown away.

42)  $248 \div 8 = 31$   
 $31 \times 6 = 186$   
Jean received 186 stickers.

43)  $280 + 186 = 466$   
 $700 - 466 = 234$   
 $234 - 178 = 56$   
The bag cost \$56.

44)  $5200 - 4570 = 630$   
 $630 \div 5 = 126$   
 $126 \times 3 = 378$   
Belinda has 378 marbles.

45)  $128 \div 8 = 16$   
 $8 \times 6 = 48$   
The perimeter is 48cm.