



RAFFLES GIRLS' PRIMARY SCHOOL

SEMESTRAL ASSESSMENT (2) 2011

| | | |
|--------------------------------|-------|-------|
| Your Score Out of 100 marks | | |
| | Class | Level |
| Highest score | | |
| Average score | | |
| Parent's Signature | | |

Name: _____ () Class: P2_____

24 October 2011 MATHEMATICS ATT: 1h 30min

Section A: (13 x 2 marks)

Choose the correct answer and write its number in the bracket provided.

1. 5 tens 42 ones = _____.

(1) 47

(3) 425

(2) 92

(4) 542

()

2. Ken bought 20 stickers.

He shared them equally among his 4 brothers.

Which number sentence shows the number of stickers each of his brothers received?

(1) $20 + 4 = 24$

(3) $20 \div 5 = 4$

(2) $20 - 4 = 16$

(4) $20 \div 4 = 5$

()

3. Eraser A is shorter than Eraser B by about _____ cm.

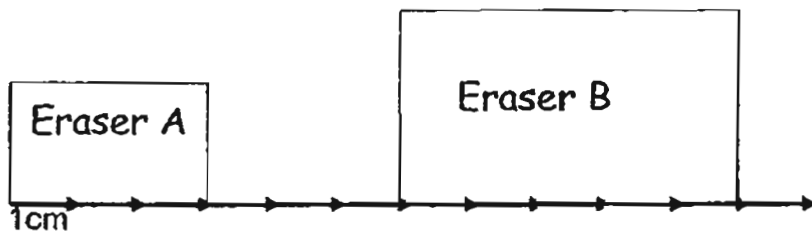

(1) 5 cm

(3) 3 cm

(2) 2 cm

(4) 8 cm

()

4. The clock below shows the time Jonathan went for his morning jog.
He had his morning jog at _____.

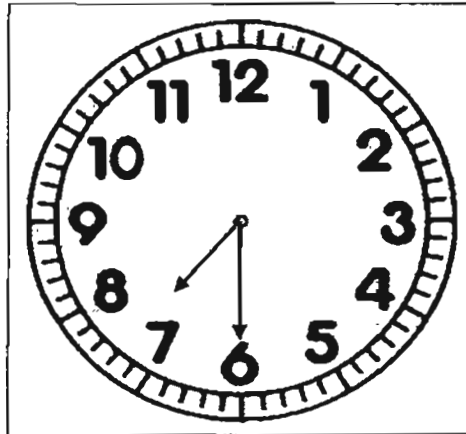

- (1) 7.30 a.m. (3) 7.30 p.m.
(2) 6.35 a.m. (4) 6.35 p.m. ()

5. The total amount of money in the purse below is _____.

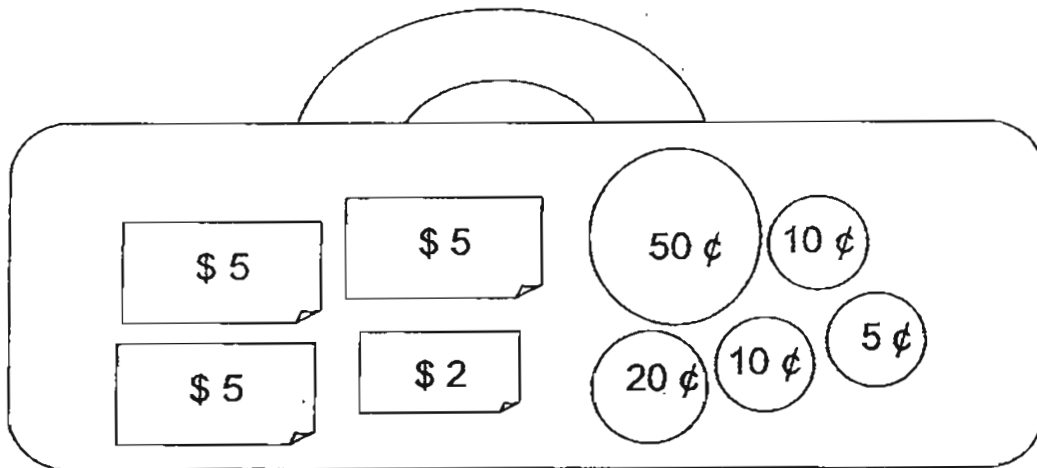

- (1) \$15.95 (3) \$17.95
(2) \$17.90 (4) \$18.00 ()

6. Which diagram below shows that $\frac{1}{4}$ of its shape is shaded?

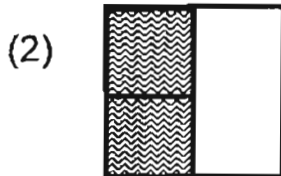
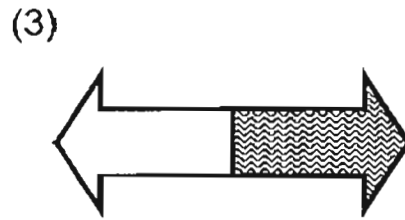
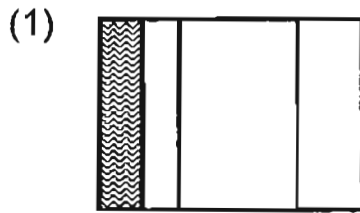

7. Tom has 49 stamps. His sister has 36 stamps more than him.
Which number sentence shows the **total** number of stamps they have?

(1) $49 - 36 = 13$

(3) $49 + 36 = 85$

(2) $85 - 36 = 49$

(4) $85 + 49 = 134$

()

8. $803 - \boxed{} = 135$

The missing number in the box is _____.

(1) 672

(3) 732

(2) 668

(4) 938

()

9. The height of my blue desk in the classroom is about _____.

(1) 1 cm

(3) 20 cm

(2) 1 m

(4) 20 m

()

10. There are _____ straight lines in the figure below.

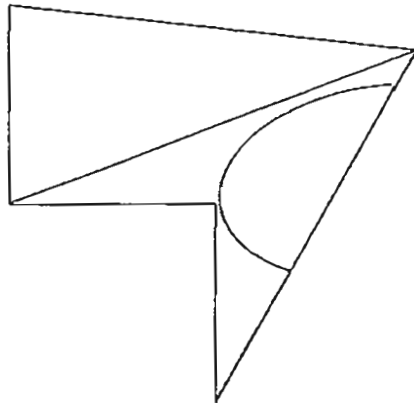

(1) 5

(3) 7

(2) 6

(4) 4

()

11. $\text{⊕} + \text{⊕} + \text{⊕} + \text{⊕} + \text{⊕} + \text{⊕} = 30$

$\text{☾} \times \text{⊕} = 15$

$\text{☾} + \text{⊕} = \boxed{?}$

(1) 5

(3) 15

(2) 8

(4) 45

()

12. $36 \div 4 = 3 \boxed{} 3$

Choose a suitable sign to be put in the box for the above number sentence.

(1) +

(3) X

(2) -

(4) ÷

()

13. 1 flask can hold 2 litres of water.
 4 such flasks of water can fill half a pail.
 How much water can 1 pail hold?

(1) 6 litres

(3) 8 litres

(2) 2 litres

(4) 16 litres

()

Section B: (28 x 2 marks)

Work out these questions carefully and write their answers in the boxes or blanks provided. Show all working.

14. 978 is 10 more than

15.
$$\begin{array}{r} 587 \\ + 15 \\ \hline \end{array}$$

16 Look at the picture below and write a **subtraction** sentence.

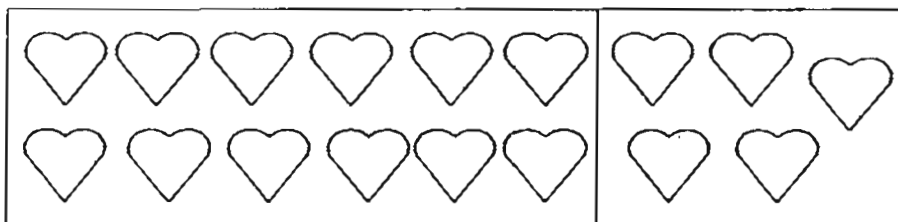

○ =

17. Measure the lines below.

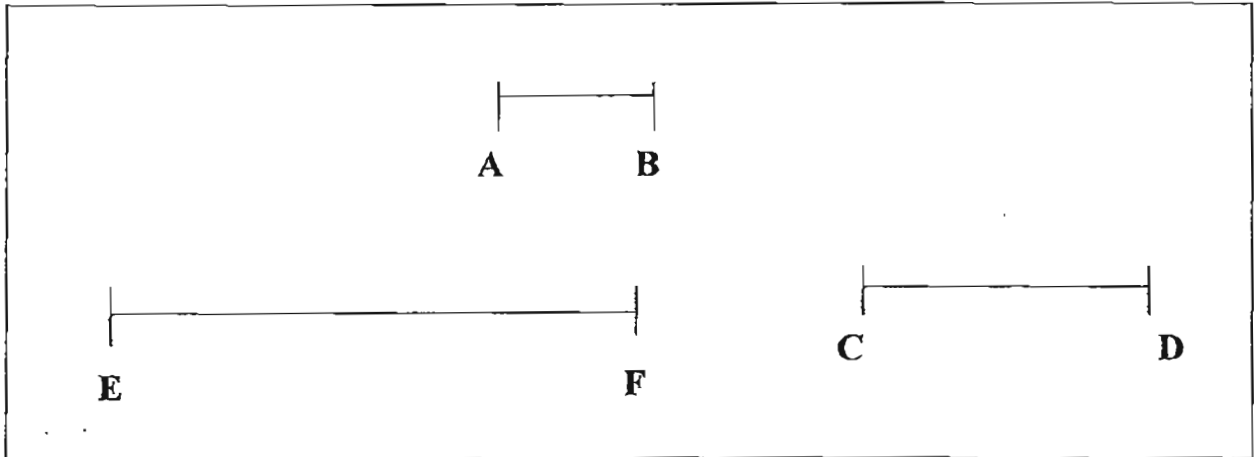

Line is about 2 cm long.

18. The picture graph below shows the favourite fruit of the pupils in Primary 2K.

Favourite Fruit of Primary 2K

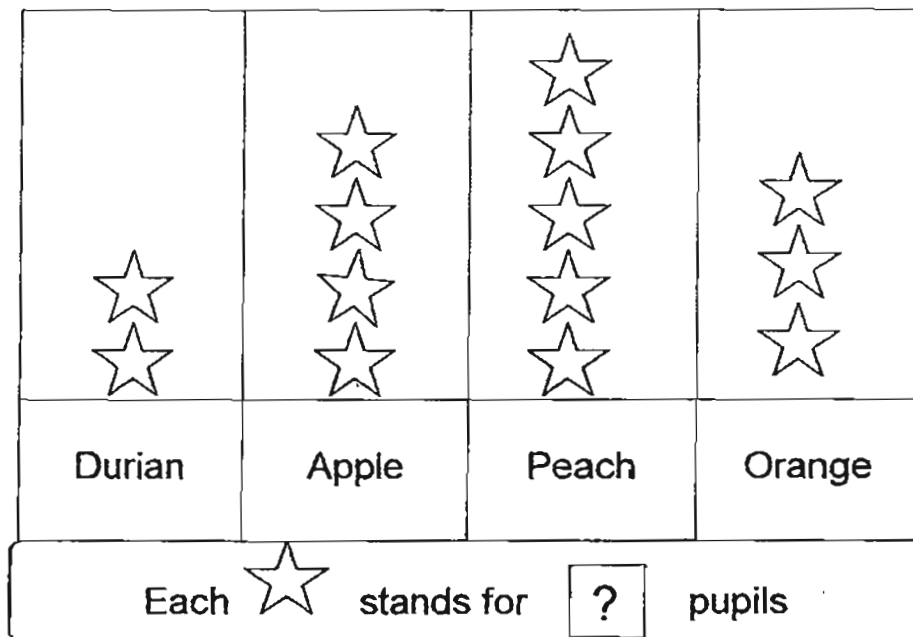

If 8 pupils like apple, what does  stand for?

Each  stands for pupils.

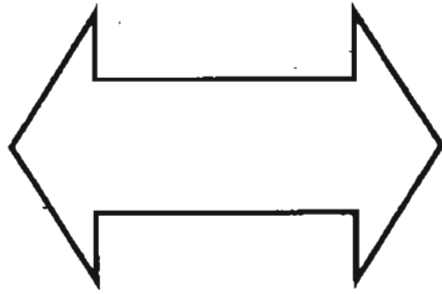

19. The figure above is made of 2 different shapes.

They are two and one

20. The 3-D object below has flat surfaces.

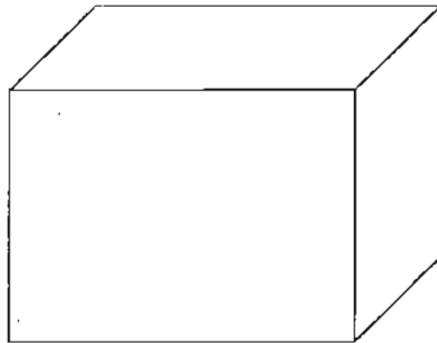

21. Colour the coins below to make \$1.

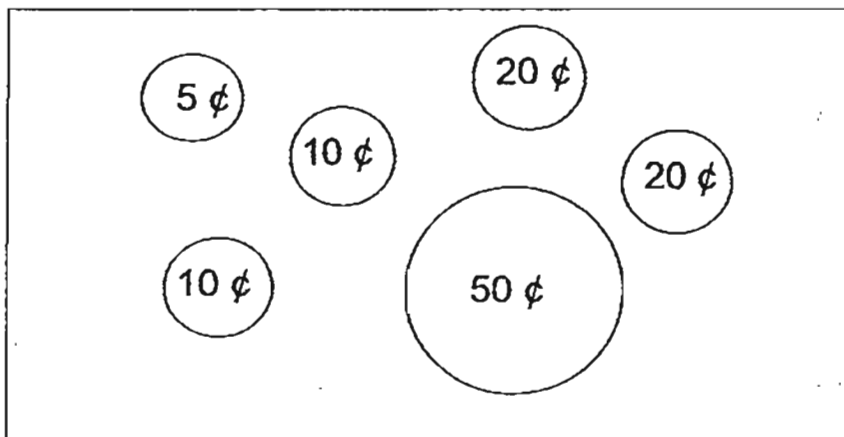

22. Arrange the set of fractions below in order. Begin with the **smallest**.

$$\frac{1}{4} , \frac{1}{12} , \frac{1}{10} , \frac{1}{2}$$

, , ,

smallest

23. Write **940** in words.

24. $787 =$ $+ 40 + 7$

25. $17 \text{ tens} - 4 \text{ tens } 3 \text{ ones} =$ ones

26. Mr. Fox had 60 turkeys. He ate 28 turkeys and shared the rest equally with his 3 cousins. How many turkeys did each cousin receive?

turkeys

27. Look at the pictures below.

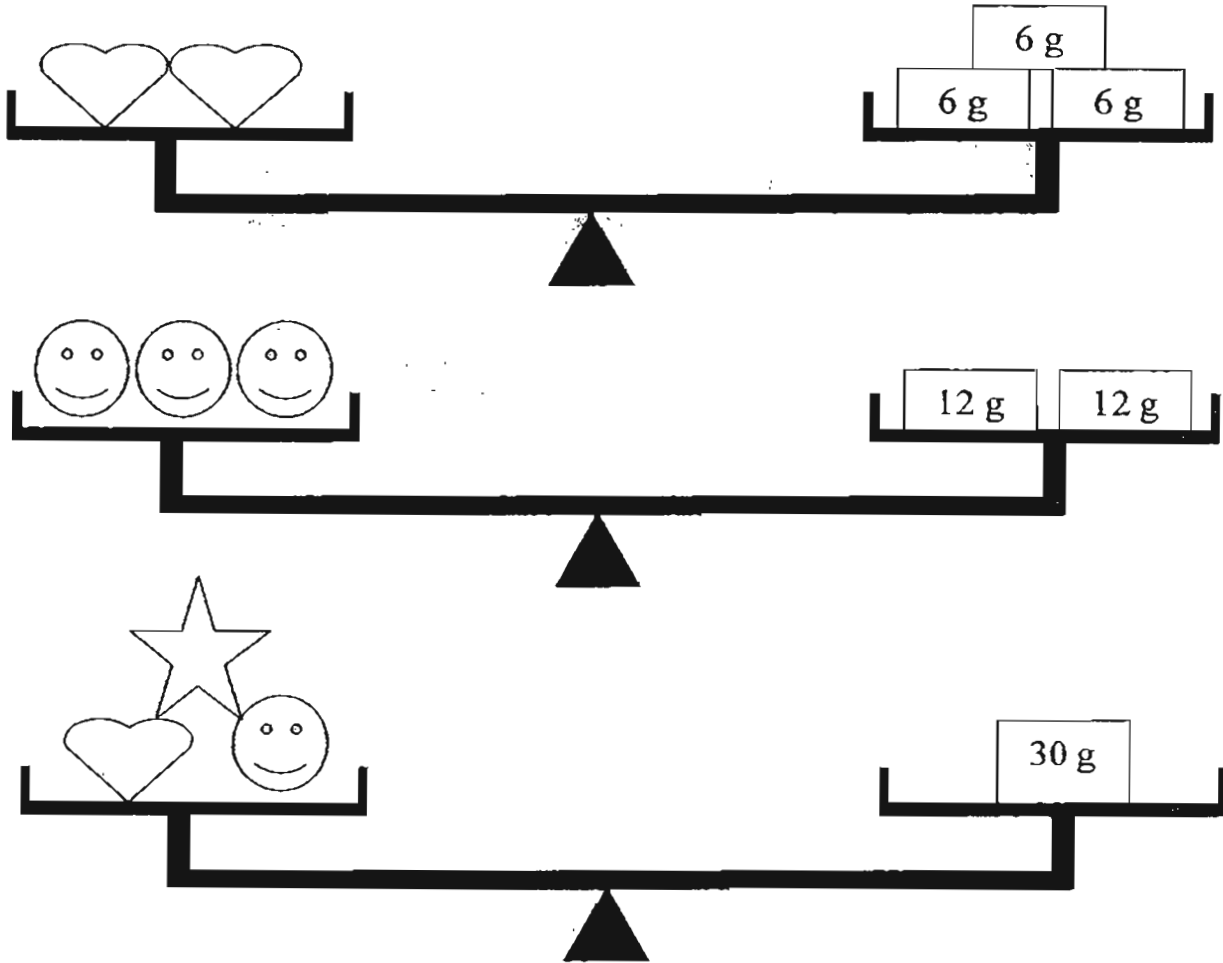

The mass of the  is g.

28. Arrange the containers A, B and C in order.

Begin with the container with the **greatest** volume of water.

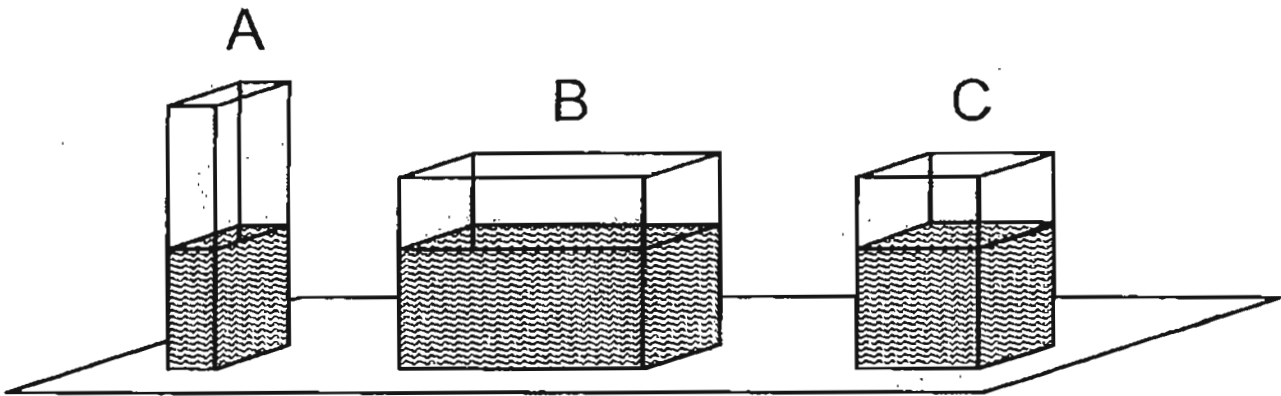

_____ , _____ , _____
greatest

29. Mary started walking to the swimming pool at 5.15 p.m.
She took 15 minutes to reach the pool.
Then, she swam for 1 hour before going home.

Fill in the time-line based on the story sum above.

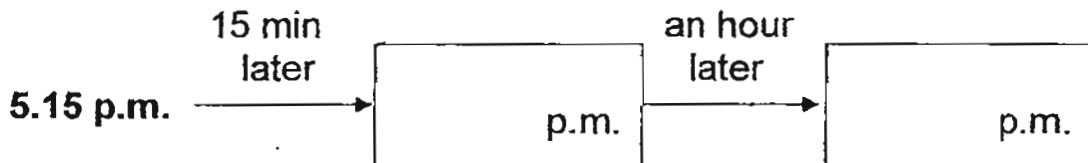

The picture graph below shows the amount of money saved by 4 children in a certain month. Study it and answer questions 30 and 31.

Amount of Money Saved

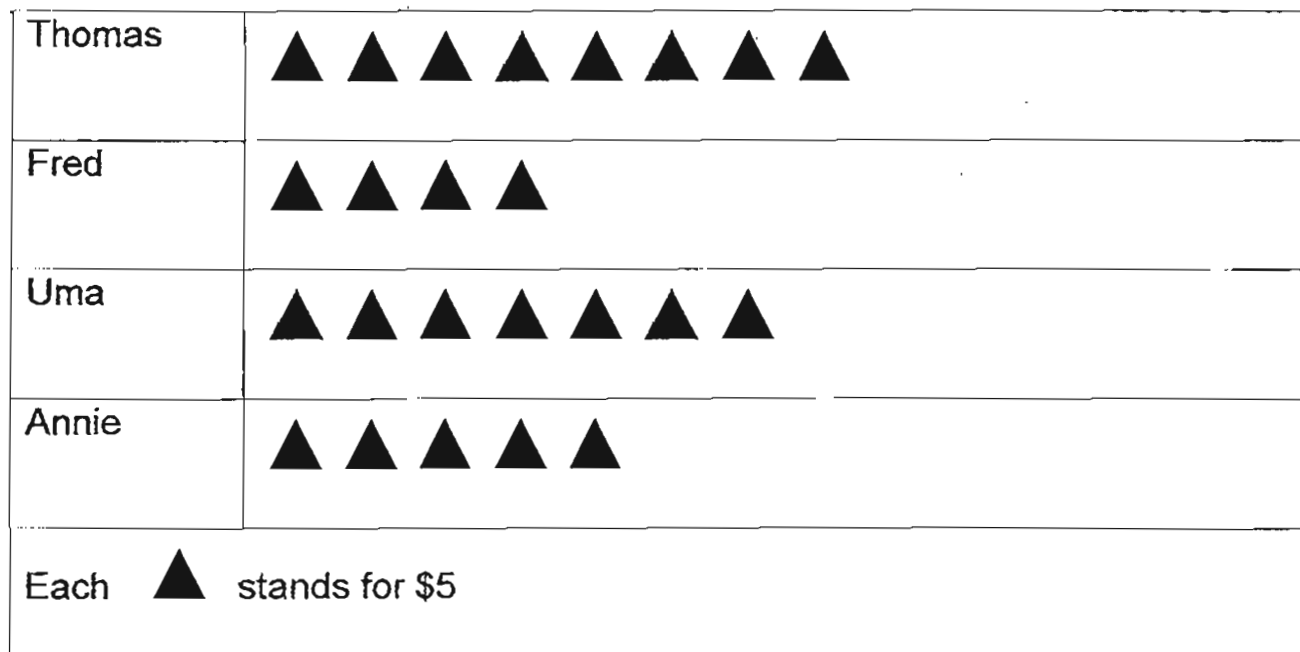

30. Fred saved \$ less than Uma.

31. Annie spent \$7 of her savings on a book and shared the rest of her savings equally among the other three children.

Thomas would have \$ now.

32. How many **curves** and **straight** lines are there in the figure below?

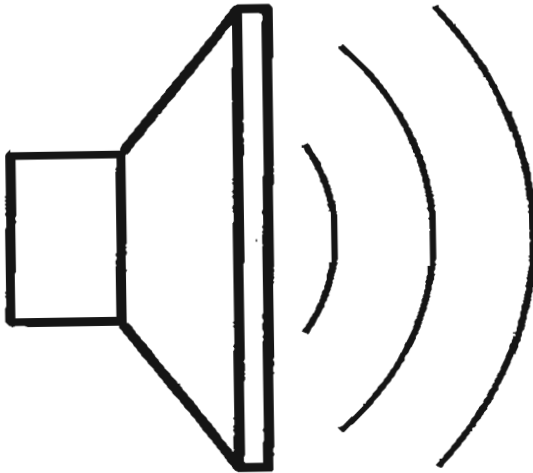

There are curves and straight lines.

33. Sammy bought a bowl of rice for \$5 and two chicken wings at \$1 each. She gave the stall keeper a \$10 note. How much change did she receive?

\$

34. What fraction of the shape below is **shaded**?

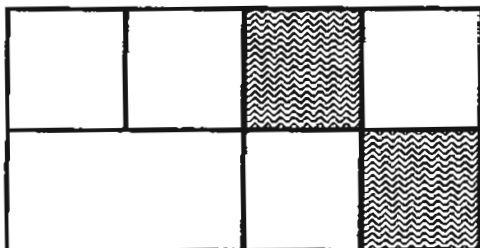

35.

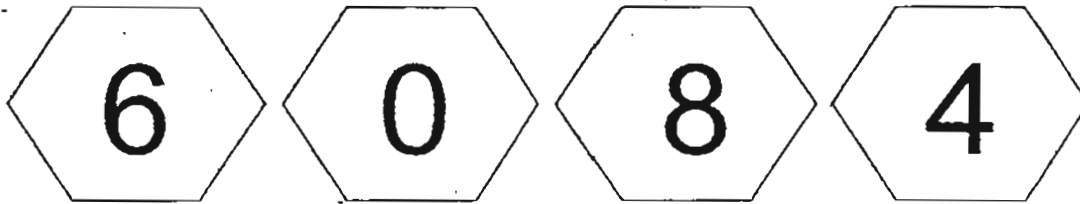

John uses 3 of the number cards above to form a 3-digit number.
The digit in the hundreds place is twice the digit in the ones place.
The digit in the tens place is 4 less than the digit in the ones place.

The 3-digit number is

36. A baker has 4 ^{boxes} baskets of tarts. The number of tarts in each ^{box} basket is shown below.

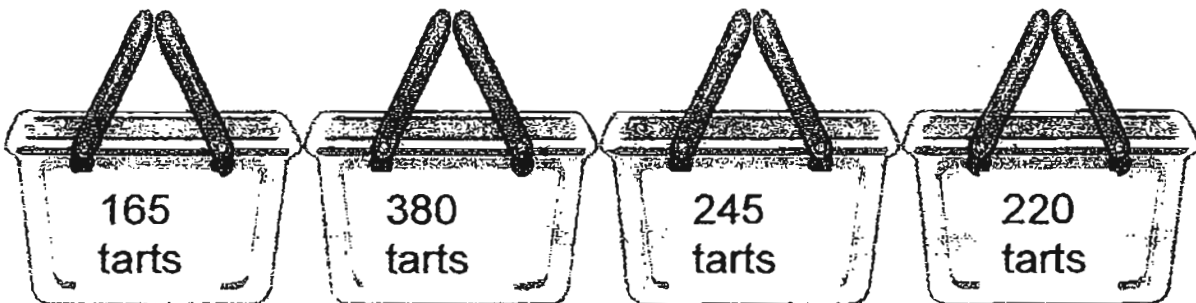

A

B

C

D

Which 3 boxes contain 630 tarts altogether?

They are Box

, Box

and Box

37. The total mass of 6 paper clips and 2 pencils is 32g.
If 1 pencil weighs 10g, what is the mass of 1 paper clip?

 g

38. Ron has 11 toy cars.
Ron has 3 more toy cars than Tony.
Melvin has thrice as many toy cars as Tony.
How many toy cars does Melvin have?

 toy cars

39. Kevin started doing his homework at 2.00 p.m. and finished
at 2.30 p.m. How long did he take to finish his homework?

 min

40. Look at the pattern.

Circle the correct object in the box to complete the pattern.

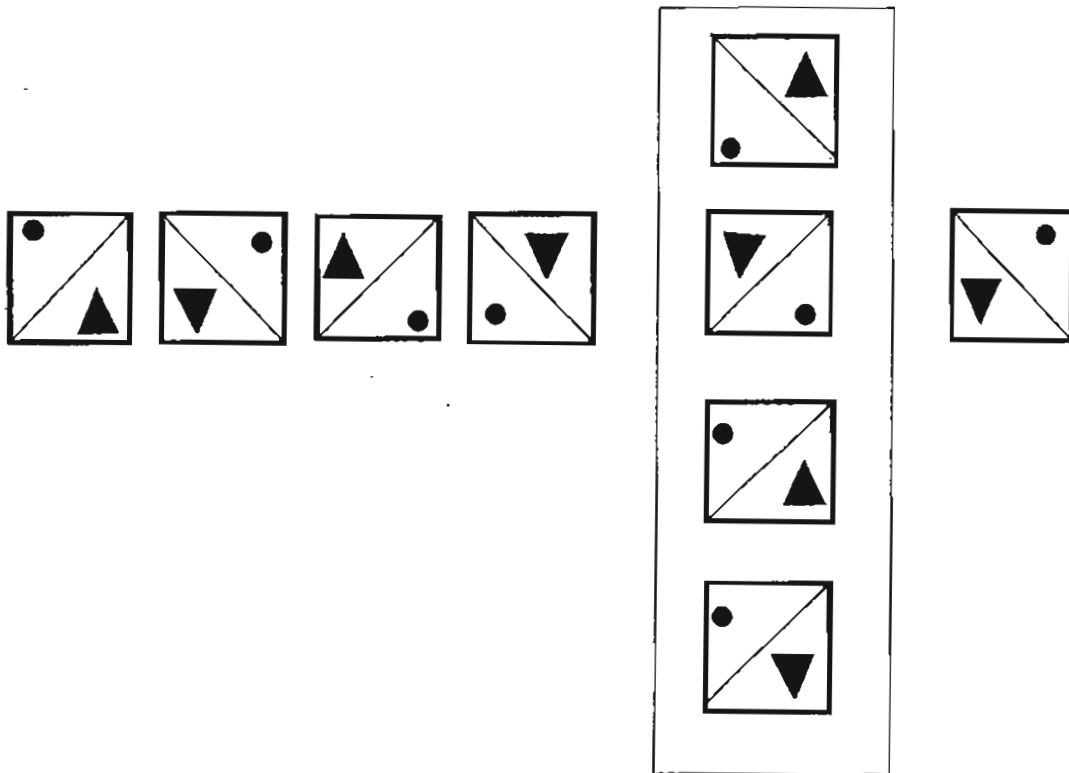

41. A pie was cut into 10 equal slices.

Tom ate 2 slices and Karen ate 3 more slices than Tom.

What fraction of the pie was left?

Section C: (6 x 3 =18 marks)

Show all number sentences and working clearly in the space provided.

42. There are 275 girls in Rosehill Primary School. There are 48 more girls than boys in the school. How many pupils are there in Rosehill Primary School?

There are _____ pupils.

43. There are 5 sweets in each box.
2 sweets are red and the rest are blue.
Carinn has 7 such boxes of sweets.
How many blue sweets does she have altogether?

Carinn has _____ sweets altogether.

blue

^

44. Complete the table below to get the answer.

Jenny started reading a storybook at 8 p.m.

She took 5 minutes to read a page.

After reading 5 pages of the book, Jenny fell asleep.

What time did she fall asleep?

| | | | | | | |
|--------|------|---|---|---|---|---|
| Start | Page | 1 | 2 | 3 | 4 | 5 |
| 8 p.m. | Time | | | | | |

Jenny fell asleep at _____.

45. Amy is 10 kg heavier than James.

James is 5 kg lighter than Bobby.

If Bobby is 47 kg, what is the total mass of the three children?

The total mass of the three children is _____ kg.

46. A notebook cost \$3.

A doll cost 5 times as much as a notebook.

Mrs Tan bought 4 notebooks and a doll.

How much did she spend altogether?

Mrs Tan spent \$ _____ altogether.

47. A chocolate bar was cut into equal pieces.

Tom ate 2 pieces, Mary ate 4 pieces and Jean ate 1 piece.

There were 5 pieces left.

What fraction of the chocolate bar was eaten?

_____ of the chocolate bar was eaten.

The End

Setters: Miss Ang Kai Mei
Mrs Clara Tang



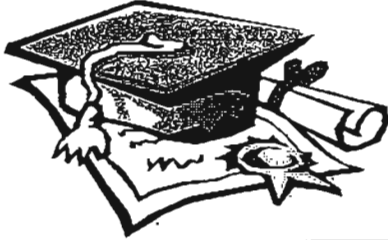

ANSWER SHEET

EXAM PAPER 2011

**SCHOOL : RAFFLES GIRLS'
SUBJECT : PRIMARY 2 MATHEMATICS**

TERM : SA2

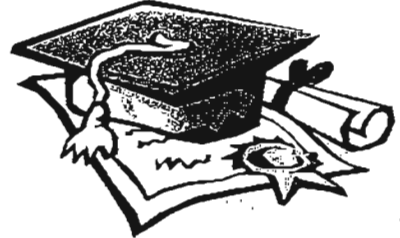

| Q1 | Q2 | Q3 | Q4 | Q5 | Q6 | Q7 | Q8 | Q9 | Q10 | Q11 | Q12 | Q13 |
|----|----|----|----|----|----|----|----|----|-----|-----|-----|-----|
| 2 | 4 | 2 | 1 | 3 | 4 | 4 | 2 | 2 | 2 | 2 | 3 | 4 |

14)968 15)602 16) $17 - 5 = 12$ 17)AB 18)2

19)triangles and rectangle 20)6 21)10¢, 20¢, 20¢, 50¢

22) $1/12, 1/10, 1/4, 1/2$ 23)nine hundred and forty 24)740

25)127 26)8 27)13g 28)B, C, A 29)5.30p.m.-->6.30p.m.

30)\$15 31)\$6 32)3, 10 33)\$3 34) $1/4$ 35)804

36)A, C, D 37)2g 38)24 toy cars 39)30 min 40)

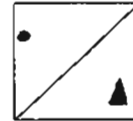

41) $3/10$

42) $275 - 48 = 227$

$$275 + 227 = 502$$

There are 502 pupils.

43) $5 - 2 = 3$

$$7 \times 3 = 21$$

Carinn has 21 blue sweets altogether.

44)Time->8.05, 8.10, 8.15, 8.20, 8.25

Jenny fell asleep at 8.25p.m.

45)Bobby = 47kg

$$\text{James} = 47 - 5 = 42\text{kg}$$

$$\text{Amy} = 42 + 10 = 52\text{kg}$$

$$\text{Total} = 47 + 42 + 52 = 141\text{kg}$$

The total mass of the three children is 141kg.

46) $3 \times 5 = 15$

$4 \times 3 = 12$

$12 + 15 = 27$

Mrs Tan spent \$27 altogether.

47) $2 + 4 + 1 + 5 = 12$

$2 + 4 + 1 = 7$

7/12 of the chocolate bar was eaten.