

Class Adm No

Candidate Name: _____

--	--

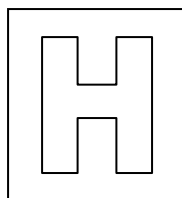

2016 Preliminary Examination II

Pre-university 3

Biology Higher 2

9648/01

Paper 1 Multiple Choice

23 September 2016

1 hour 15 minutes

Additional Materials: Optical answer sheet

READ THESE INSTRUCTIONS FIRST

Do not open this booklet until you are told to do so.

Write your name, Adm No. and class on all the papers you hand in.
Do not use staples, paper clips, highlighters, glue or correction fluid.

Paper 1

There are **forty** questions in this paper. Answer **all** questions. For each question, there are four possible answers, **A, B, C** and **D**. Choose the **one** you consider correct and record your choice in **soft pencil** on the separate Multiple Choice Answer Sheet.

Calculators may be used.

This question paper consists of 30 printed pages

[Turn over

Answer **all** questions

1. The diagram shows two isomers of a hexose labelled **I** and **II**. Four possible bonding positions are labelled **d**, **e**, **f**, **g** and **h** on one isomer, and **s**, **t**, **u**, **v** and **w** on another isomer.

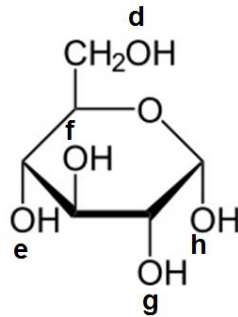

Isomer I

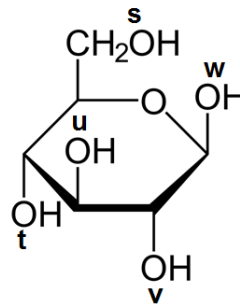

Isomer II

Which isomer and bonding positions are involved in the formation of amylopectin?

	Repeating units	Bonding position
A	Isomer I	d-g and d-h
B	Isomer I	e-h and d-h
C	Isomer II	s-v and s-w
D	Isomer II	t-w and s-w

2. Reindeer are well adapted to survive extreme cold winters. One of these adaptations is the cell membrane composition at different parts of its body. The graph below shows the percentage composition of cell surface membrane components of Cell X and Cell Y taken from two different parts of the reindeer's body.

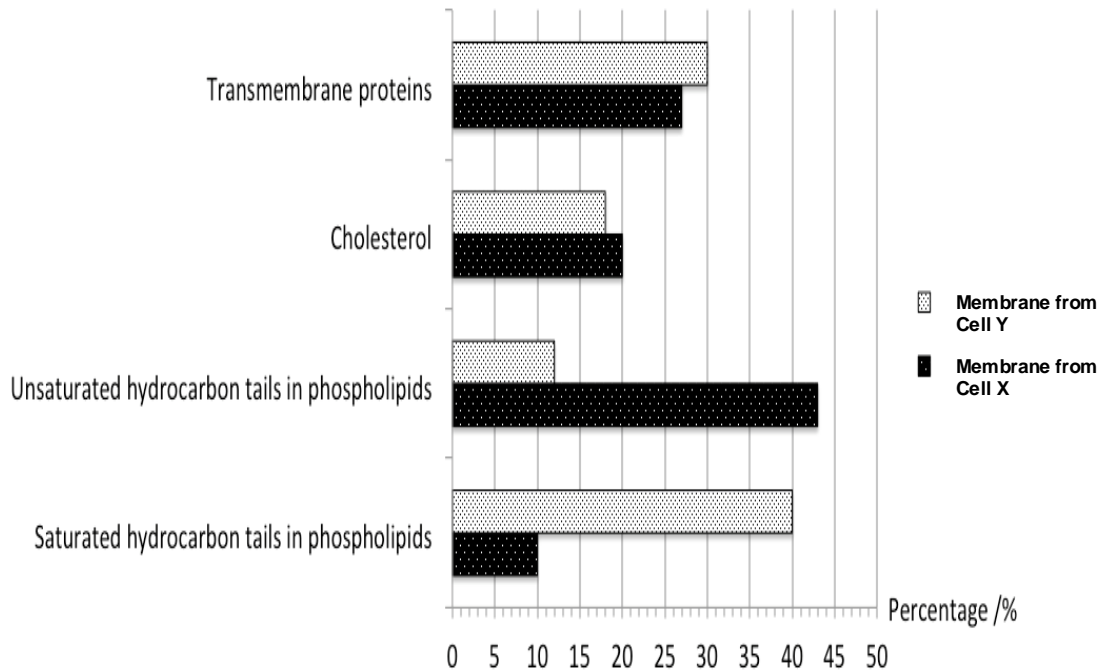

Which of the following statement best explains the differences in the membrane composition in Cell X and Cell Y?

- A** Cholesterol decreases the membrane fluidity and prevents the membrane from breaking up by restraining the movement of phospholipids.
- B** Cell X is taken from a lower part of the reindeer's leg as the unsaturated hydrocarbon tails in the cell surface membrane will prevent the fatty acids from packing close to each other.
- C** Cell Y is taken from a lower part of the reindeer's leg as the saturated hydrocarbon tails in the cell surface membrane will prevent the fatty acids from packing close to each other.
- D** Transmembrane proteins maintain the osmotic balance between the interior and exterior of the cell, hence preventing the cell membrane from solidifying at low temperatures.

3. What is the role of a biological catalyst in a metabolic reaction?
- A Increases both the activation energy and the energy yield.
 - B Decreases the activation energy and increases the energy yield.
 - C Decreases both the activation energy and the energy yield.
 - D Decreases the activation energy and has no influence on the energy yield.
4. The diagram shows a mitochondrion drawn from an electron micrograph.

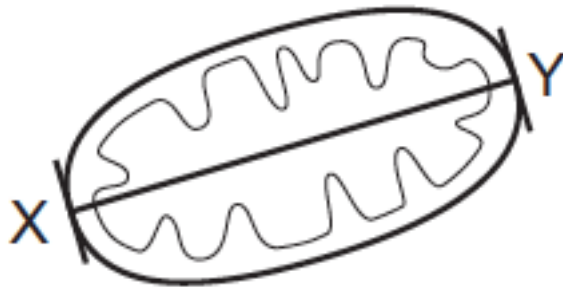

The length of the mitochondrion from X to Y is 3000 nm.

What is the magnification of the drawing of the mitochondrion?

- A X 200
- B X 2000
- C X 20000
- D X 200000

5. The following figure shows the results of an experiment, in which, samples containing the same concentration of enzyme and substrate were kept at different temperatures for periods of one, two and five hours. The quantities of product formed were then determined.

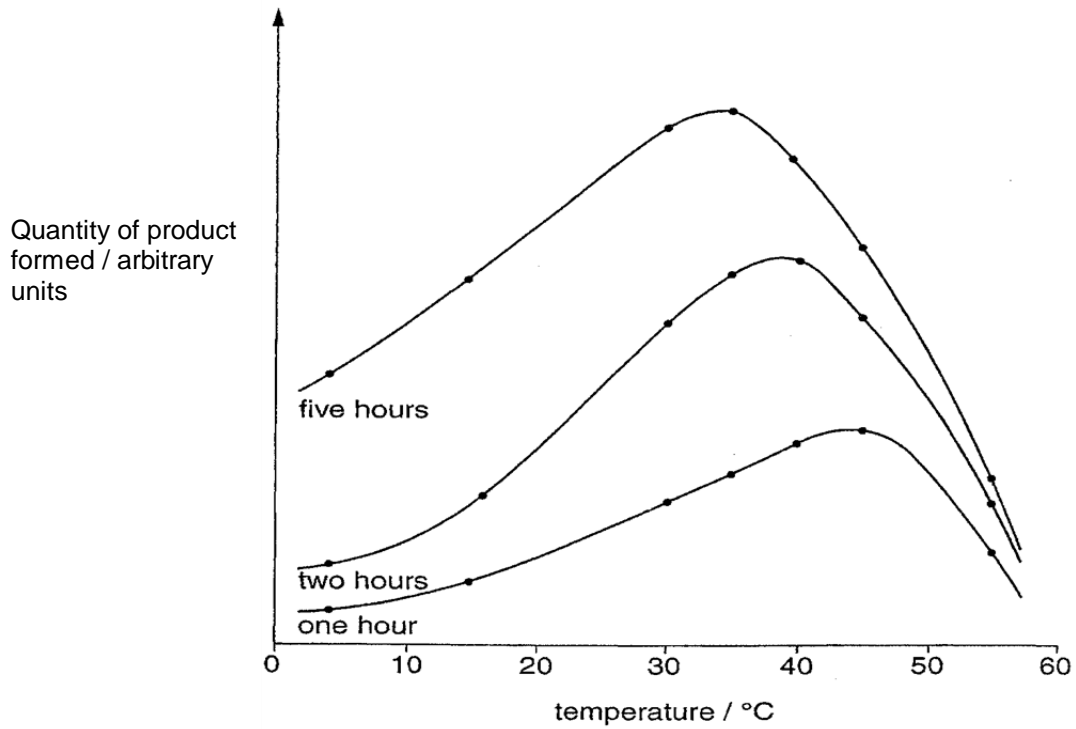

Which statement below does not describe the graphs?

- A As temperature increased, the quantity of products formed increased.
- B As the duration of the experiment decreased, the quantity of products decreased.
- C The enzyme is not active at 50°C for when the experiment is carried out for five hours.
- D Optimum temperature for the experiment held over one hour was highest as the enzyme had more disulfide bonds in stabilizing its structure.

6. The amount of DNA per nucleus in a mouse cell during a meiotic cell cycle, as shown below, was measured.

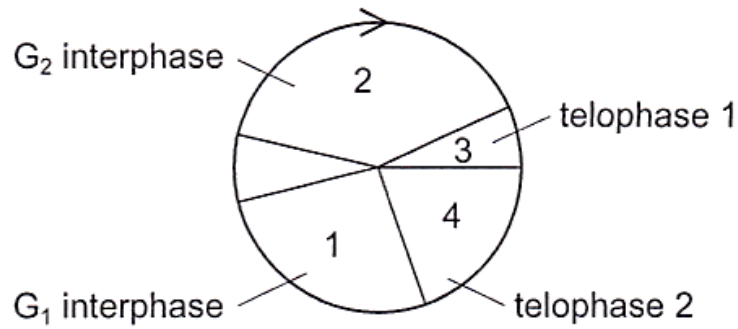

Which bar correctly represents the variation in DNA content?

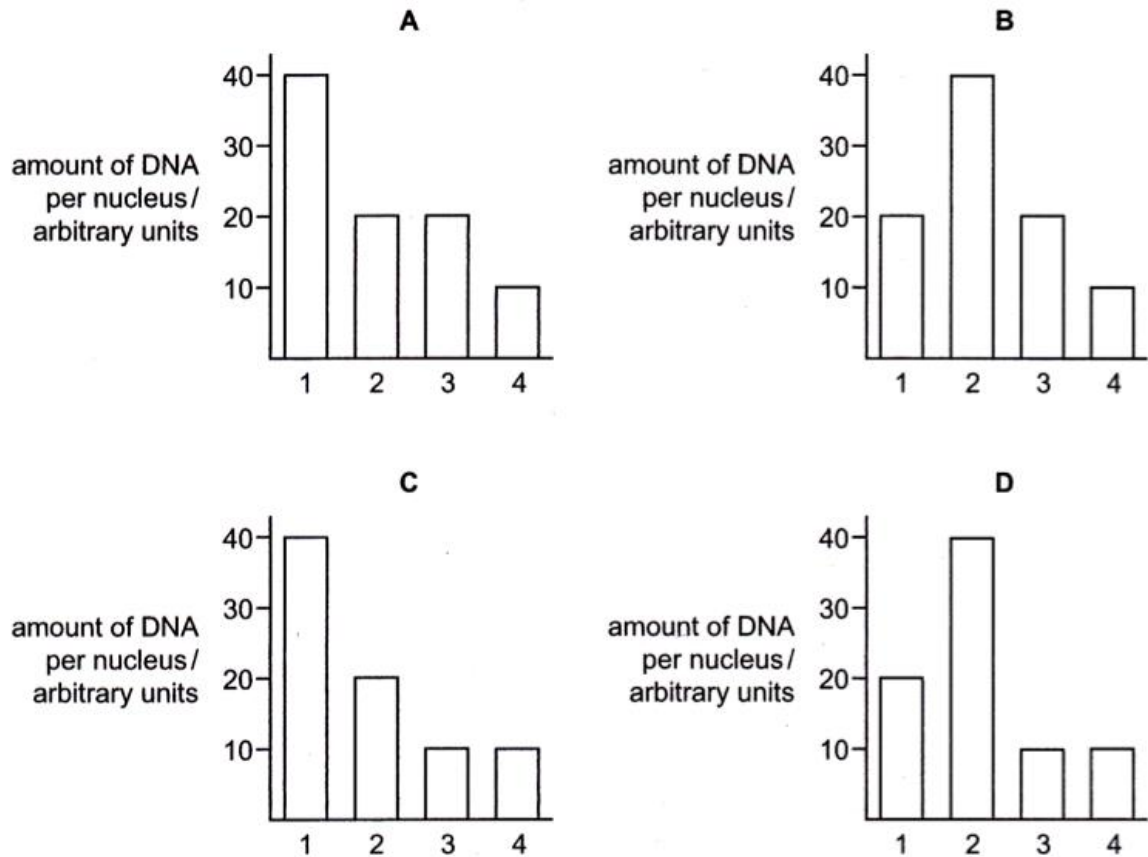

7. The diagram shows two homologous chromosomes in early prophase I of meiosis in a mouse cell. Two genes, A/a and B/b, whose loci occur on the homologous chromosomes are also shown.

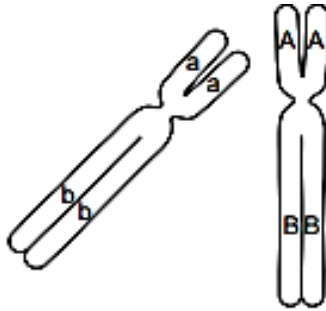

Which option is a possible representation of these chromosomes as they progress from anaphase I to prophase II?

	anaphase I	prophase II
A		
B		
C		
D		

8. The diagram shows a DNA template with the lagging strand prior to the removal of the RNA primers.

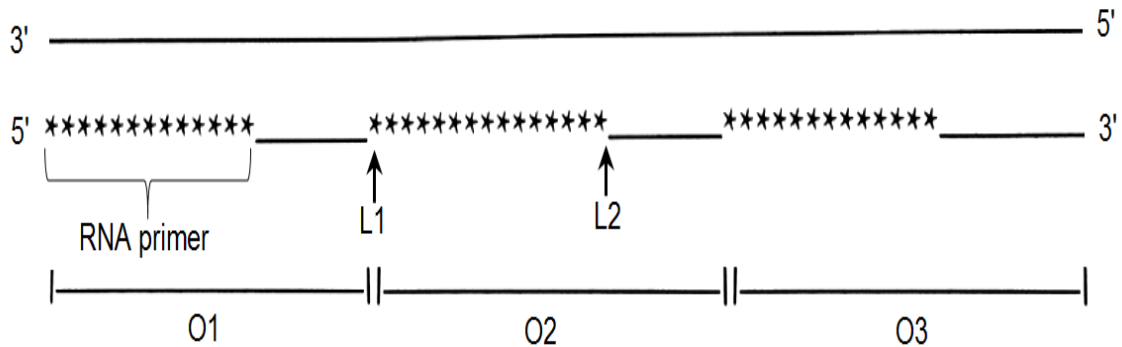

Which row correctly shows the events taking place during the synthesis of the lagging strand?

	First Okazaki fragment synthesised	Site of phosphodiester bond formation catalysed by DNA ligase
A	O1	L1
B	O1	L2
C	O3	L1
D	O3	L2

9. In a laboratory of Molecular Biology, the amino acids sequence of a cockroach intestine protein has been partially determined. The tRNA molecules used in the synthesis have the following anticodons:

3' UAC 5' 3' CGA 5' 3' GGA 5' 3' GCU 5' 3' UUU 5' 3' GGA 5'

What is the DNA nucleotide sequence of the non-template DNA strand?

- A** 5' ATG-GCT-GGT-CGA-AAA-CCT 3'
B 5' ATG-GCT-CCT-CGA-AAA-CCT 3'
C 5' ATG-GCT-GCT-CGA-AAA-GCT 3'
D 5' ATG-GGT-CCT-CGA-AAA-CGT 3'

10. A number of molecules other than tRNA and mRNA are involved during translation.

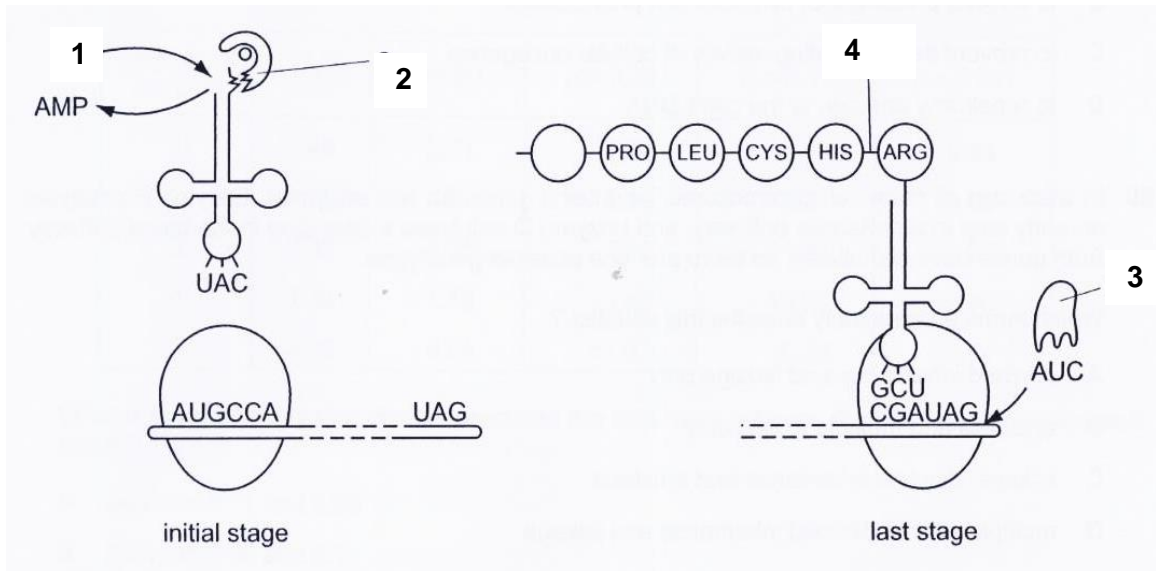

Which line in the table is correct for labels 1 – 4?

	1	2	3	4
A	ADP	Aminoacyl tRNA synthetase	Amino acid	Hydrogen bond
B	ADP	Amino acid	Release factor	Hydrogen bond
C	ATP	Aminoacyl tRNA synthetase	Release factor	Peptide bond
D	ATP	Amino acid	Aminoacyl tRNA	Peptide bond

11. Which of the following statements is true about prokaryotic plasmids?

- A** Plasmids replicate along with the chromosomal DNA by using chromosomal DNA as a template.
- B** Antibiotic-resistant genes on plasmids allow them to survive in antibiotic culture medium.
- C** Plasmid DNA strands run in opposite directions and the copy number varies with the type of plasmid.
- D** Binary fission ensures that plasmids are equally separated into daughter cells.

12. The globin gene family in humans consists of the α , β and γ genes. These genes code for the globin chains that make up haemoglobin and are expressed at different levels during different developmental stages.

The graph shows the expression of the various globin chains during the prenatal (fetal) and postnatal (after birth) periods.

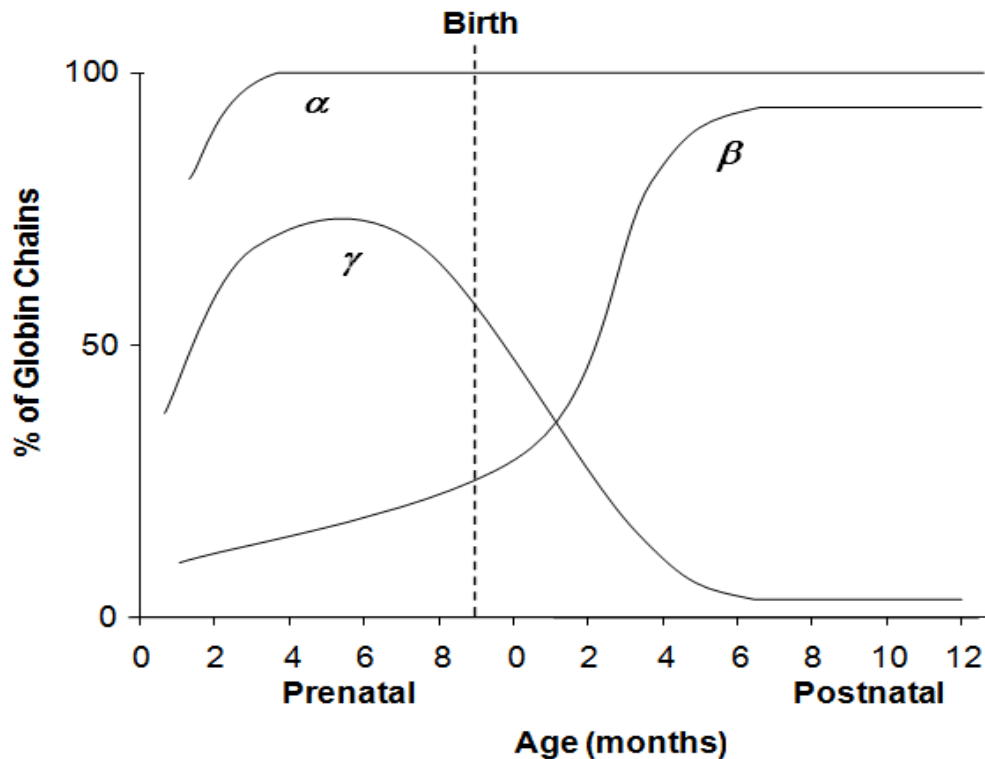

Which statement cannot account for the differences in the levels of expression of globin chains?

- A Methyl groups are added to regulatory sequences of γ -globin gene during the postnatal period, allowing for chromatin remodeling complexes to be recruited.
- B Alternative splicing occurs in the mature mRNA of the α -globin and β -globin genes, resulting in differences in the rate of expression of globin chains during the prenatal period.
- C A growth factor triggers the expression of a transcription factor that increases the rate of β -globin gene expression during the postnatal period.
- D The shortening of poly(A) tail in the mRNA of γ -globin genes reduces its stability, resulting in a decrease in the rate of expression of γ -globin chains during the postnatal period.

13. An analysis of the cells of a cancer patient revealed the presence of abnormal amounts of Ras proteins.

Which of the following could not explain for this observation?

- A Gene amplification of Ras proto-oncogene
 - B A point mutation in a control element of the Ras proto-oncogene
 - C Translocation of Ras proto-oncogene to a region under the control of a more active promoter
 - D A single substitution in the exon of Ras proto-oncogene
14. A point mutation has occurred in *Escherichia coli*. Glucose and lactose are both absent in the culture medium where the mutant *E. coli* is grown in. An analysis of proteins synthesised by mutant *E. coli* found substantial amount of β -galactosidase, transacetylase and permease.

Which of the following mutations could have taken place in the *E. coli* cell?

- 1 Mutation in the operator of the lac operon
 - 2 Mutation in the *lacI* gene
 - 3 Mutation in the promoter of the lac structural genes
- A 1 only
 - B 2 only
 - C 1 and 2 only
 - D 2 and 3 only

15. In an experiment to study genetic recombination, two strains of *Escherichia coli* with different nutritional requirements were used. Strain **A** ($met^- bio^- thr^+ leu^+ thi^+$) would grow on a minimal medium only if the medium were supplemented with methionine and biotin, while Strain **B** ($met^+ bio^+ thr^- leu^- thi^-$) would grow on a minimal medium only if it was supplemented with threonine, leucine and thiamine.

Some of the dishes were plated only with Strain **A** bacteria, some only with Strain **B** bacteria, and some with a mixture of Strain **A** and Strain **B** bacteria that had been incubated together for several hours in a liquid medium.

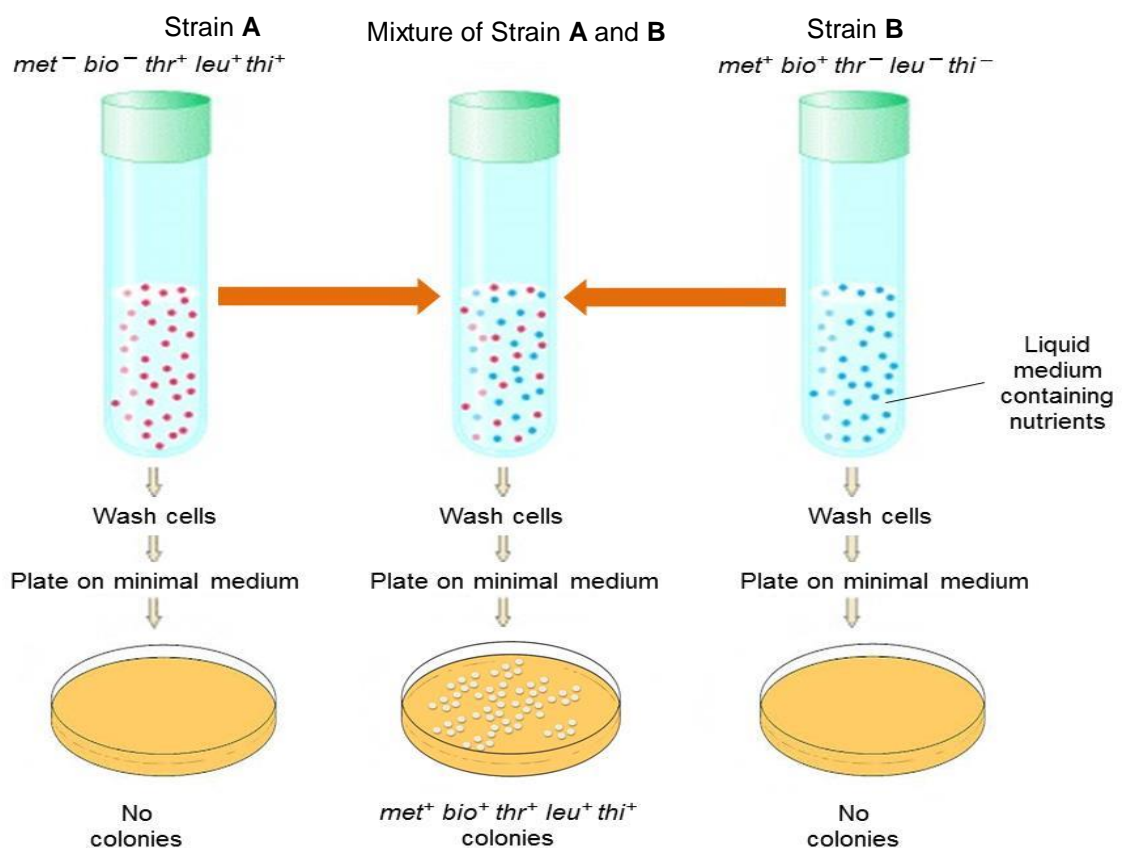

Which conclusion can be best drawn from the experiment?

- A The thr^+ , leu^+ and thi^+ genes in Strain **A** are located in its F plasmid.
- B Cell-to-cell contact is necessary for the exchange of alleles between strain **A** and strain **B**.
- C All the five genes are located on the F plasmid.
- D Mutations resulted in thr^+ , leu^+ and thi^+ genes in Strain **B** to produce colonies on a minimal medium plate.

16. The human immunodeficiency virus (HIV) has a highly specific gp120 glycoprotein that only allows it to infect cells with a CD4 receptor. To increase the host range of HIV in a laboratory setting, scientists often modify these viruses by artificially enclosing the viral nucleocapsid with a viral envelope with VSV-G glycoproteins embedded. VSV-G binds to LDL receptor, found ubiquitously on the cell membranes of many cell types, including kidney and liver cells that HIV do not usually infect.

A scientist has taken the following experimental steps:

1. Extracted an original and unmodified HIV nucleocapsid from wild-type HIV
2. Artificially enclose HIV nucleocapsid in a viral envelope containing VSV-G glycoproteins
3. Infect liver cells
4. Extract only newly synthesized virus particles released and examined them

What can the scientist expect to find in most newly synthesized virus particles extracted?

	Viral envelope	Viral Genome
A	VSV-G	VSV-G gene
B	VSV-G	gp120 gene
C	gp120	VSV-G gene
D	gp120	gp120 gene

17. During summer, an isolated population of bighorn ram on a mountain has been captured and the length of their curled horns was measured over 30 years. Horn length of bighorn ram follows a distribution similar to that of its weight.

Which of the following statements describing the features of horn length in bighorn sheep are not correct?

- 1 Horn length is controlled by multiple alleles with different degrees of dominance.
- 2 Horn length shows quantitative expression with overlaps between categories.
- 3 Horn length is polygenic where inherited individual alleles have an additive effect.
- 4 Horn length is not affected by the environment

A 1 and 2 only

B 1 and 4 only

C 2 and 3 only

D 3 and 4 only

18. Which of the following causes variation in both sexually and asexually reproducing organisms?

A Mutation

B Polygenic inheritance

C Crossing over

D Independent assortment

19. Possession of white or coloured feathers in chickens is controlled by two genes **P/p** and **Q/q**. The phenotypes of offspring that are expected from mating two chickens, each of which is heterozygous at both loci, are shown in the Punnett square.

Gametes	PQ	Pq	pQ	pq
PQ	White feathers	White feathers	White feathers	White feathers
Pq	White feathers	White feathers	White feathers	White feathers
pQ	White feathers	White feathers	Coloured feathers	Coloured feathers
pq	White feathers	White feathers	Coloured feathers	White feathers

What best explains the proportion of white to coloured feathers in the Punnett square?

- A Dominant epistasis in which the epistatic allele is **P**
 - B Dominant epistasis in which the epistatic allele is **Q**
 - C Recessive epistasis in which the epistatic allele is **p**
 - D Recessive epistasis in which the epistatic allele is **q**
20. There are two hypotheses to explain the production of white, pale blue or dark blue flowers in a species of plant.

Hypothesis 1: There are two codominant alleles for flower color

Hypothesis 2: There are three alleles, one for each flower colour.

Which procedure is the best way of testing these hypotheses?

- A Analysis of the flower pigments in several different flowers by chromatography to find whether some plants contain more than one pigment.
- B Controlled cross pollination of all the different colour varieties available, in all possible combinations, and recording the colours shown by the offspring.
- C Surveying large wild populations and finding the ratios of the different colours in these.
- D Controlled self-pollination of several individuals of each of the colour varieties and recording the colours shown by the offspring of each individual plant sampled.

21. The following claims have been made about respiration.

- 1 Two turns of the citric acid cycle is required to oxidize 1 molecule of glucose.
- 2 Four molecules of carbon dioxide are generated for every molecule of acetyl CoA introduced into the Krebs Cycle.
- 3 During aerobic respiration, glucose produces pyruvate, CO₂ and ATP in the cytoplasm of a muscle cell.
- 4 Aerobic respiration can produce about 19 times the amount of ATP produced in anaerobic respiration.

Which of the following statements is/are true?

- A 1 only
 - B 1 and 4 only
 - C 2 and 4 only
 - D 1, 3 and 4 only
22. *Rafflesia arnoldii* is a parasitic plant that produces the world's largest flower. It survives by invading the underground roots of vines to absorb nutrients essential for polypeptide synthesis. By doing so, it makes use of the nutrients to develop a giant and stinking flower that smells of rotting flesh in order to attract pollinating flies.

Which of the following two factors are most likely to act as limiting factors and inhibit growth of the vines when the *Rafflesia* parasite is present?

- 1 Carbon dioxide
 - 2 Light
 - 3 Photosynthetic enzymes
 - 4 Water
 - 5 Temperature
- A 1 and 2
 - B 2 and 3
 - C 3 and 4
 - D 4 and 5

23. Which of the following gives an accurate comparison between intracellular receptors and cell surface receptors?

	Intracellular receptors	Cell surface receptors
A	May act as regulatory proteins and bind to DNA	May catalyse the phosphorylation of intracellular proteins
B	Functions as the second messenger to activate other relay proteins	Binding of ligand always trigger the production of second messengers
C	Ligands can be water-soluble or lipid-soluble	Ligands must be lipid-soluble
D	Made up of only hydrophobic amino acids to allow the interaction with lipid-soluble ligands.	Made up of hydrophobic amino acids which interact with the phospholipids of the membrane

24. Which of the following statements about channel proteins is/are correct?

- I Channel proteins are either voltage-gated, ligand-gated or mechanically-gated.
- II Channel proteins do not undergo conformational changes when transporting molecules.
- III Channel proteins contain a hydrophilic pore lined with hydrophilic amino acids.
- IV Channel proteins serve to transport hydrophilic molecules of all sizes across the cell membrane.

- A I and II only
- B II and III only
- C I, II and III only
- D All of the above

25. Concentrations of glycerate-3-phosphate (GP) and ribulose biphosphate (RuBP) were measured from samples of actively photosynthesising green algae in an experimental chamber.

Which of the following graphs show how the concentration of these compounds changes when the light source was turned off?

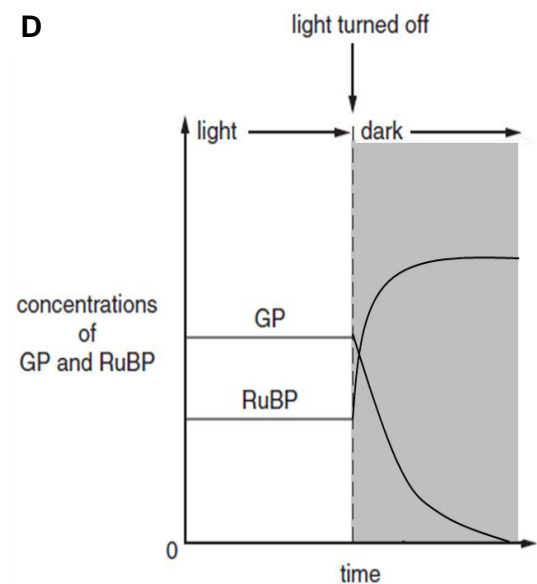
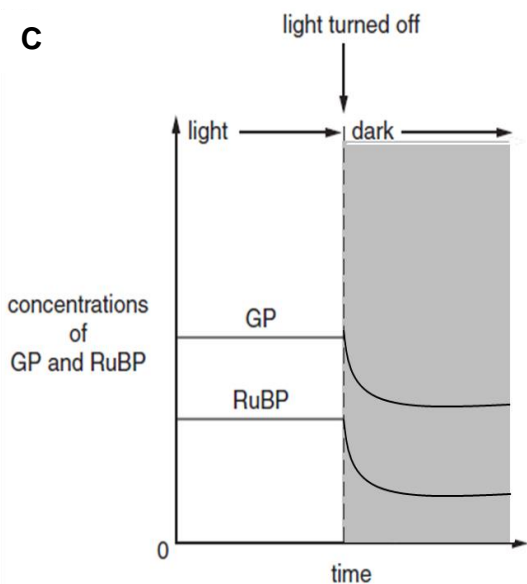
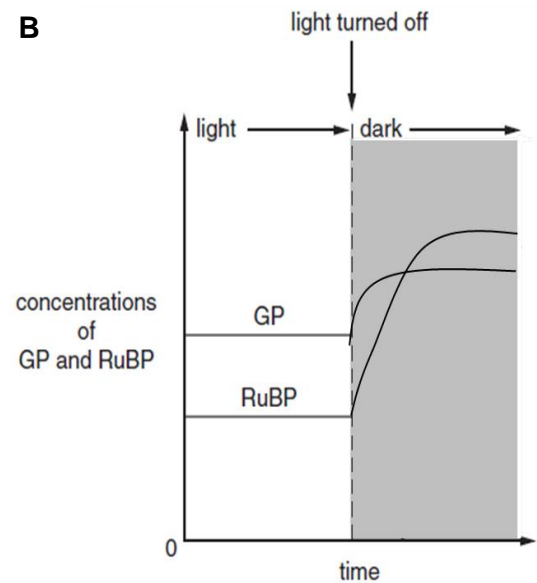
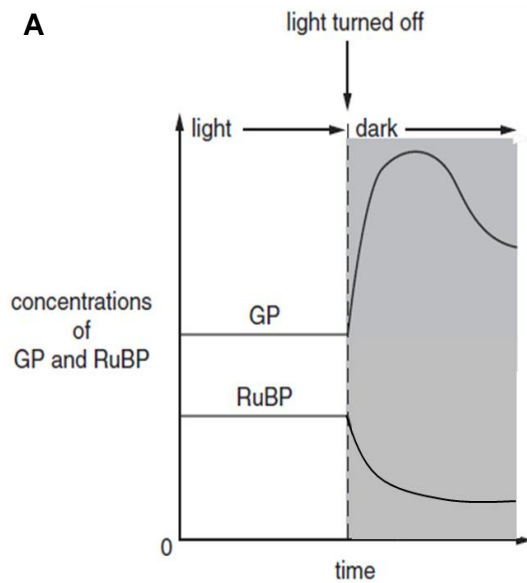

26. The following diagram shows the activation of the G protein-coupled receptor (GPCR) by the binding of adrenaline to the receptor. A mutation leads to constitutive signal transduction.

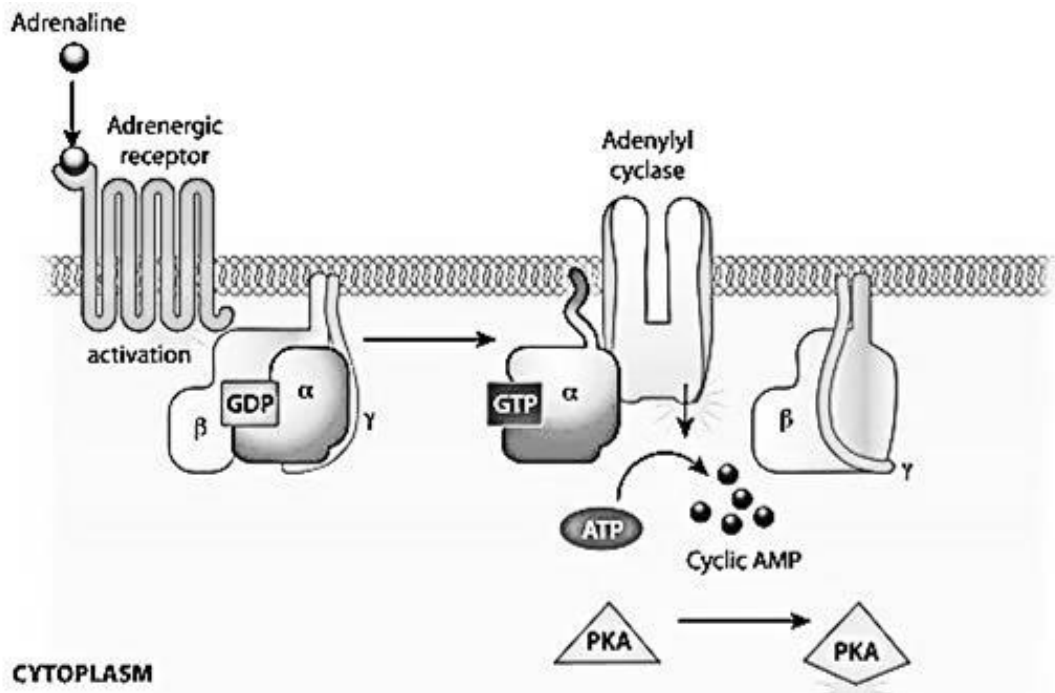

Which of the following is a possible result of the mutation?

- A Conformational change in adenylyl cyclase such that it cannot convert ATP to cyclic AMP.
- B Adrenaline not being able to bind to the receptor.
- C Cyclic AMP not being able to bind to PKA.
- D GTPase in G protein failing to hydrolyse GTP to GDP.

27. The diagram below shows a normal action potential.

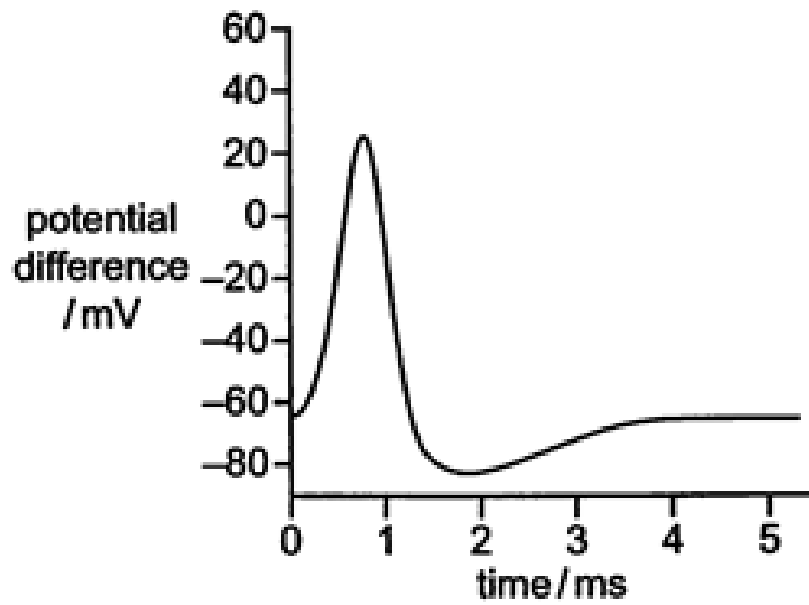

Drug X can bind and block voltage-gated K^+ channels.

Which of the following diagrams shows an action potential in a neurone affected by such a drug?

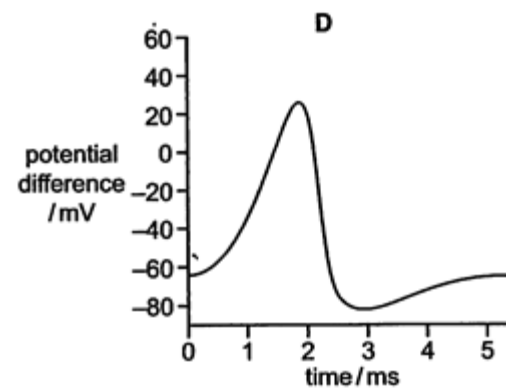
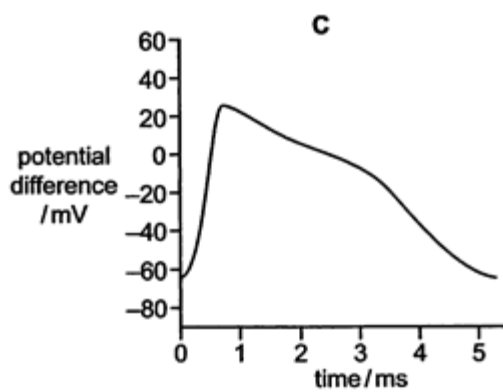
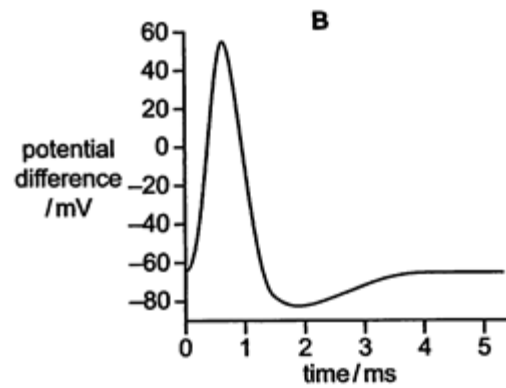
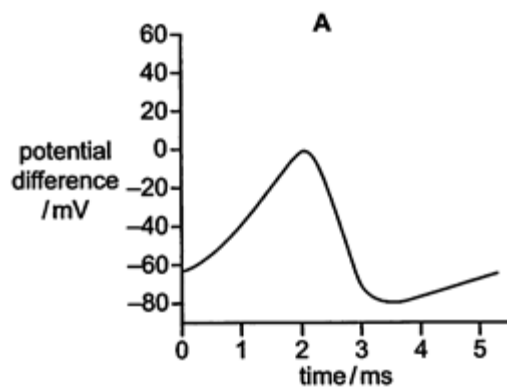

28. Which is a correct description of the role of calcium ions in synaptic signalling?
- A Calcium ions are moved in by diffusion through ligand gated ion channels in pre-synaptic membranes of excitatory neurons, causing vesicles to move towards the pre-synaptic membrane as an impulse arrives.
 - B Calcium ions are moved in by diffusion through voltage gated ion channels in pre-synaptic membranes of excitatory neurons, causing vesicles to move towards the pre-synaptic membrane as an impulse arrives.
 - C Calcium ions are moved in by active transport through calcium pumps in pre-synaptic membranes of excitatory neurons, causing vesicles to move towards the pre-synaptic membrane as an impulse arrives.
 - D Calcium ions are moved out by active transport through calcium pumps in pre-synaptic membranes of excitatory neurons, causing vesicles to move towards the pre-synaptic membrane as an impulse arrives.

29. The production of testosterone is regulated by the anterior pituitary gland. Upon stimulation by hormone K, the gland releases hormone L which causes the testes to produce testosterone. The elevated level of testosterone exerts a negative feedback on the anterior pituitary gland.

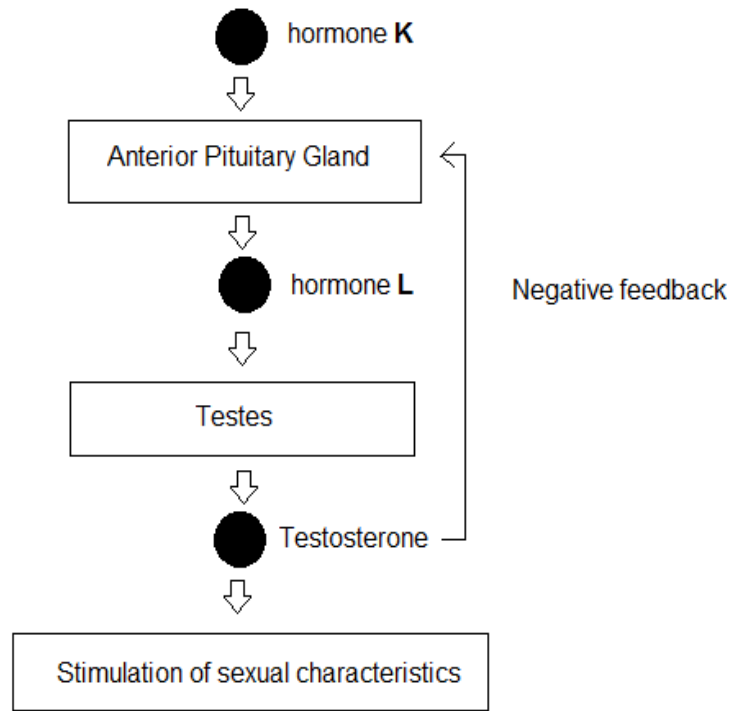

Which of the following would be observed if a man consumes large amount of steroids containing testosterone?

	Production of hormone K	Production of hormone L	Production of testosterone	Stimulation of sexual characteristics
A	Decrease	Decrease	Decrease	No change
B	Decrease	Decrease	No change	Increase
C	No change	Decrease	Decrease	Increase
D	No change	Decrease	Decrease	No change

30. Which of the following is not a limitation of the use of fossil records as evidence for evolution?
- A Fossils are damaged and incomplete.
 - B Some organisms may not form fossils.
 - C Fossils are found in different sedimentary rock layers.
 - D Fossils present in inaccessible areas are not available to us for study.
31. The following statements relate to molecular phylogenetics.
- 1 Lines of descent from a common ancestor to present-day organisms have undergone similar and fixed rates of DNA mutation.
 - 2 Organisms with similar base sequences in their DNA are closely related to each other.
 - 3 The number of differences in the base sequences of DNA of different organisms can be used to construct evolutionary trees.
 - 4 The proportional rate of fixation of mutations in one gene relative to the rate of fixation of mutations in other genes stays the same in any given line of descent.

Which statements, when taken together, suggest the existence of a 'molecular clock' that enables scientists to estimate the time at which one species might have diverged from another?

- A 1 and 2 only
- B 1 and 4 only
- C 2 and 3 only
- D 3 and 4 only

32. The northern elephant seal almost became extinct in the late 1800's following harvesting by whalers and sealers for their blubber which contains oil. A small colony of between 20 and 100 individuals survived on Guadalupe Island off Baja California. This colony has since given rise to about 160,000 elephant seals on the Pacific coast today. The following figure compares the distribution of elephant seals between 1900 and 2005.

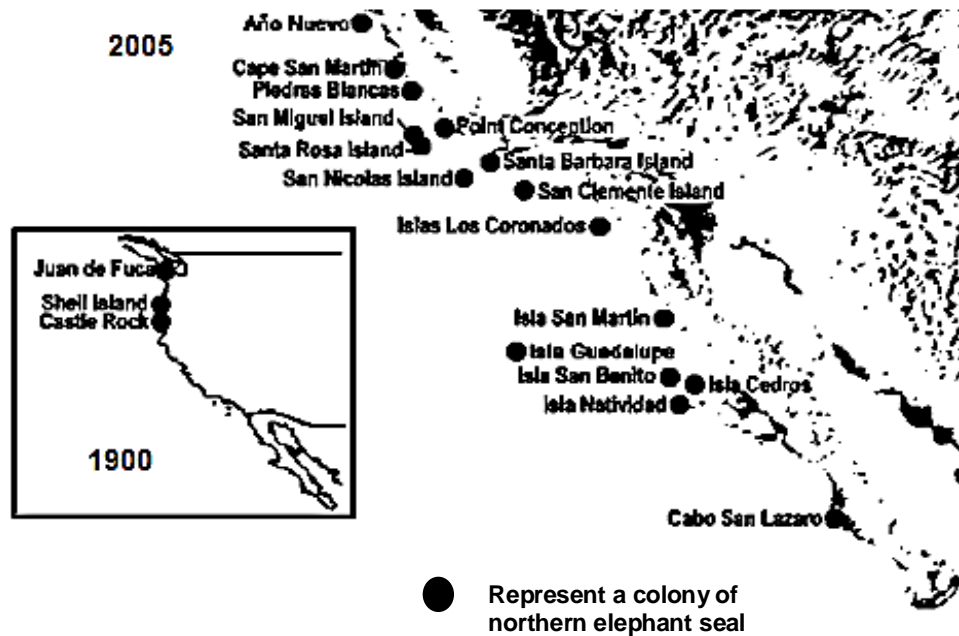

Which evolutionary mechanism could best explain why the degree of homozygosity is higher in the recent population of elephant seals compared to the original population in the 1800s?

- A Directional selection
- B Bottleneck effect
- C Founder effect
- D Genetic drift

33. The soapberry bug, *Jadera haematoloma*, uses its long beak to penetrate the fleshy fruit of the native soapberry tree to feed on the seeds at the centre. The bug also feeds on the fruit of the introduced golden rain tree.

Investigators measured the beak length of the soapberry bugs over eighty years. The results are shown in the graph.

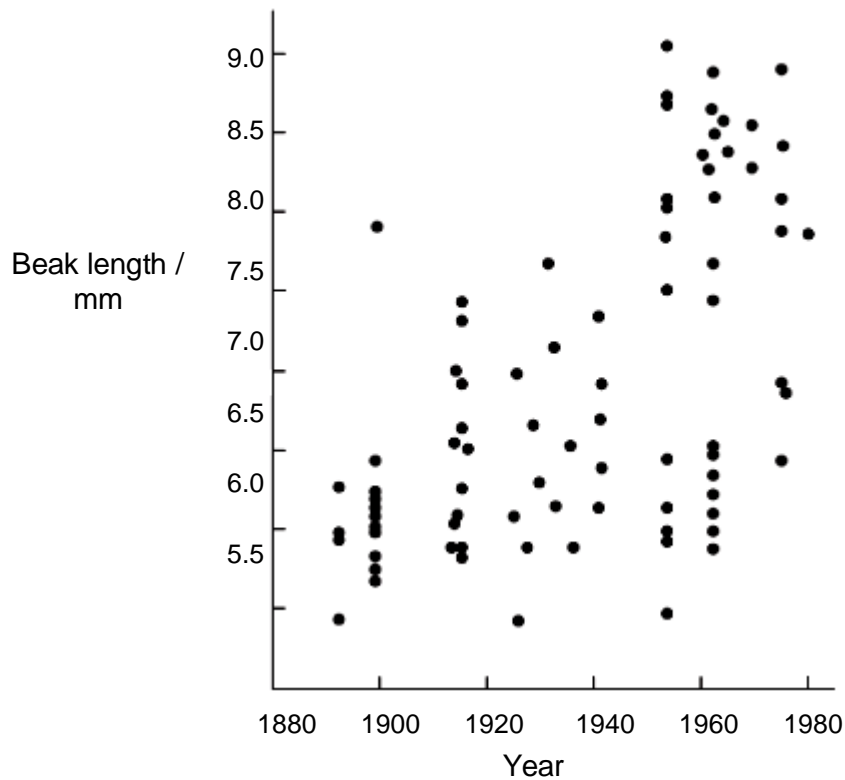

Which of the following statements is a reasonable conclusion based on the above information?

- A The golden rain tree was introduced around 1970.
- B The change in beak length is an example of stabilizing selection.
- C The diameter of the golden rain tree fruit acted as a selection pressure on beak length.
- D The response of an individual golden rain tree to predation by soapberry bugs would be to grow larger fruit.

34. EcoRI is a restriction enzyme produced by *Escherichia coli*. It recognises the sequence GAATTC and is able to make a staggered cut in the DNA. *E. coli* is susceptible to attack by bacteriophages.

Which of the following correctly describes the natural function of EcoRI?

- A It lowers infectivity rate of *E. coli* by bacteriophages that have double-stranded DNA as their genetic material, since EcoRI can recognise and cleave specific viral nucleotide sequences.
- B It cleaves *E. coli* DNA sequences to produce restriction fragments that can be packaged into bacteriophages for infection of new bacterial cells.
- C It increases infectivity rate of *E. coli* by bacteriophages because it promotes cleavage of viral DNA at specific nucleotide sequences in order to package more viral DNA into new virus particles.
- D It cleaves *E. coli* DNA sequences so that the bacterial cell which has been infected will undergo autolysis and self-destruct, preventing further infection of new bacterial cells.

35. Menkes' syndrome in humans is characterised by sparse and wiry hair, growth failure and deterioration of the nervous system. Onset of the Menkes' syndrome usually occurs during infancy.

A family, in which this X-linked disorder was present, underwent Restriction Fragment Length Polymorphism (RFLP) analysis using gel electrophoresis. The family pedigree is shown below.

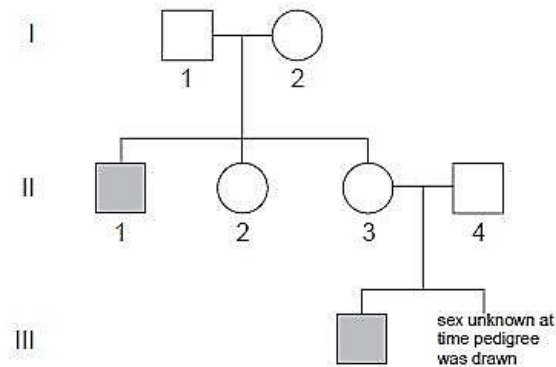

The RFLP analysis resulted in the following distribution of bands in the gel.

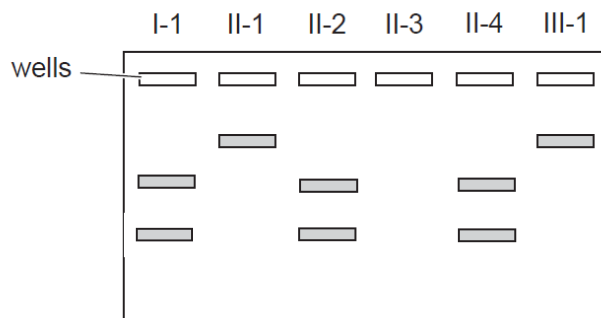

What would be the band pattern of individual II-3?

A **B** **C** **D**

36. Which of the following options correctly describe the events occurring in each process?

	Action of restriction enzyme	Ligation	Annealing	Denaturation
A	Breaking of hydrogen bonds	Formation of hydrogen bonds	Formation of phosphodiester bonds	Breaking of phosphodiester bonds
B	Breaking of hydrogen bonds	Formation of hydrogen bonds	Formation of phosphodiester bonds	Formation of phosphodiester bonds
C	Breaking of phosphodiester bonds	Formation of phosphodiester bonds	Formation of hydrogen bonds	Breaking of hydrogen bonds
D	Breaking of phosphodiester bonds	Formation of phosphodiester bonds	Breaking of hydrogen bonds	Formation of hydrogen bonds

37. Which of the following are ethical concerns arising from the Human Genome Project?

- 1 Scientists tracing migration of different population groups based on maternal inheritance
- 2 Genetic counsellors giving advice to people who are genetically pre-disposed to risks
- 3 Parents choosing to abort foetuses with minor disorders based on genetic testing results
- 4 Scientists developing tests for only some disease-causing genes
- 5 Employers refraining from hiring people with greater risk of developing genetic diseases

- A** 1 and 4
B 2 and 5
C 3 and 4
D 3 and 5

38. Which of the statements about stem cells are false?

- 1 Embryonic stem cells are useful as they have the ability to differentiate into any cell type.
- 2 Embryonic stem cells are less easily isolated compared to neural crest stem cells.
- 3 Umbilical cord blood stem cells have the same developmental potential as neural crest stem cells.
- 4 Induced pluripotent stem cells undergo differentiation to give rise to various cell lineages.
- 5 Stem cells have the ability to self-renew without any stimulus.

- A 1, 2 and 5 only
B 1, 4 and 5 only
C 2, 3 and 4 only
D 3, 4 and 5 only

39. One way to treat β -thalassaemia is to transplant bone marrow cells from a genetically compatible donor into a patient. A potential gene therapy involves adding the normal and dominant allele for β -globin to the patient's cells.

What would ensure that the normal gene is passed on to the next generation?

- A Using a retrovirus to introduce the normal β -globin gene into bone marrow cells.
B Using an adenoviral vector to introduce the normal β -globin gene into bone marrow cells.
C Using an adenoviral vector to introduce the normal β -globin gene into an egg cell.
D Using a retrovirus to introduce the normal β -globin gene into an egg cell.

40. Which of the following is an example of genetically modified organisms?
- A Cows that grow to adult sizes quickly due to injection of recombinant bovine somatotropin
 - B Durians that ripen slower due to anti-sense technology
 - C High yielding rice that are flood resistant, due to intensive self-pollination over generations
 - D Cows that grow to abnormal size due to inbreeding

End Of Paper

Class Adm No

Candidate Name: _____

--	--

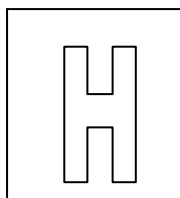

2016 Preliminary Examination II

Pre-university 3

Biology Higher 2

9648/01

Paper 1 Multiple Choice

23 September 2016

1 hour 15 minutes

Additional Materials: Optical answer sheet

READ THESE INSTRUCTIONS FIRST

Do not open this booklet until you are told to do so.

Write your name, Adm No. and class on all the papers you hand in.
Do not use staples, paper clips, highlighters, glue or correction fluid.

Paper 1

There are **forty** questions in this paper. Answer **all** questions. For each question, there are four possible answers, **A, B, C** and **D**. Choose the **one** you consider correct and record your choice in **soft pencil** on the separate Multiple Choice Answer Sheet.

Calculators may be used.

This question paper consists of 30 printed pages

Answer **all** questions

1. The diagram shows two isomers of a hexose labelled **I** and **II**. Four possible bonding positions are labelled **d**, **e**, **f**, **g** and **h** on one isomer, and **s**, **t**, **u**, **v** and **w** on another isomer.

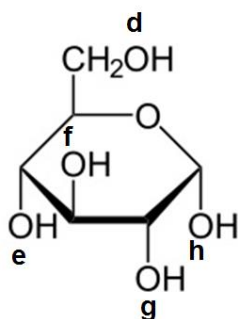

Isomer I

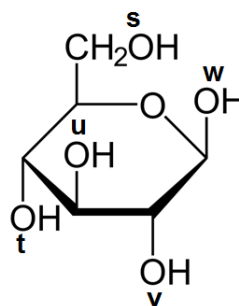

Isomer II

Which isomer and bonding positions are involved in the formation of amylopectin?

	Repeating units	Bonding position
A	Isomer I	d-g and d-h
B	Isomer I	e-h and d-h
C	Isomer II	s-v and s-w
D	Isomer II	t-w and s-w

2. Reindeer are well adapted to survive extreme cold winters. One of these adaptations is the cell membrane composition at different parts of its body. The graph below shows the percentage composition of cell surface membrane components of Cell X and Cell Y taken from two different parts of the reindeer's body.

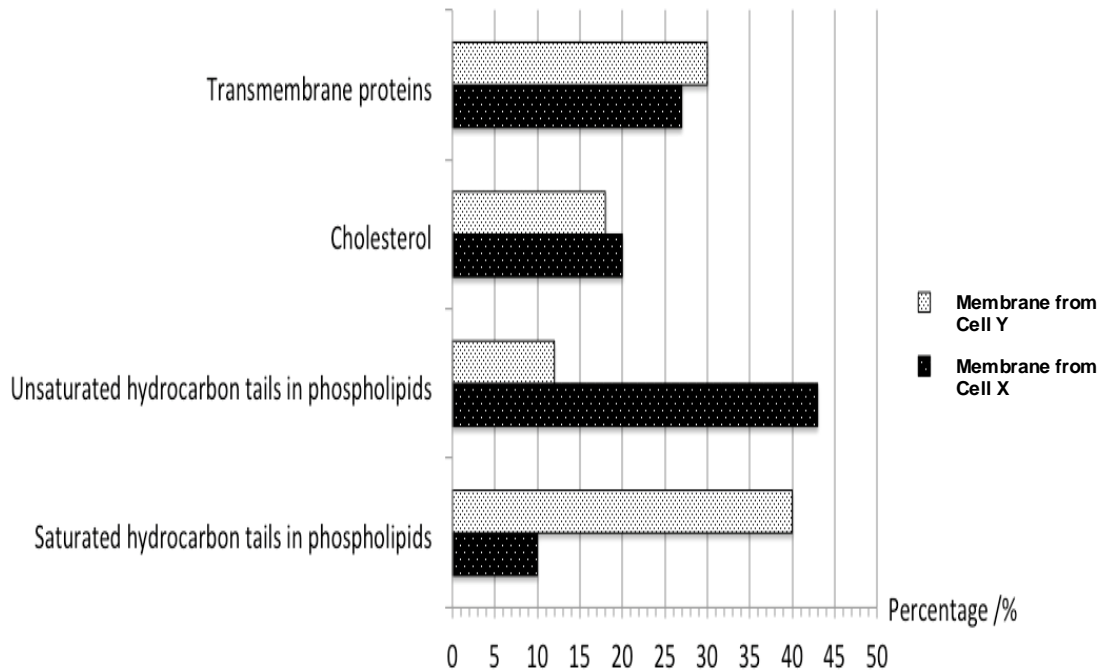

Which of the following statement best explains the differences in the membrane composition in Cell X and Cell Y?

- A Cholesterol decreases the membrane fluidity and prevents the membrane from breaking up by restraining the movement of phospholipids.
- B Cell X is taken from a lower part of the reindeer's leg as the unsaturated hydrocarbon tails in the cell surface membrane will prevent the fatty acids from packing close to each other.
- C Cell Y is taken from a lower part of the reindeer's leg as the saturated hydrocarbon tails in the cell surface membrane will prevent the fatty acids from packing close to each other.
- D Transmembrane proteins maintain the osmotic balance between the interior and exterior of the cell, hence preventing the cell membrane from solidifying at low temperatures.

3. What is the role of a biological catalyst in a metabolic reaction?
- A Increases both the activation energy and the energy yield.
 - B Decreases the activation energy and increases the energy yield.
 - C Decreases both the activation energy and the energy yield.
 - D Decreases the activation energy and has no influence on the energy yield.**
4. The diagram shows a mitochondrion drawn from an electron micrograph.

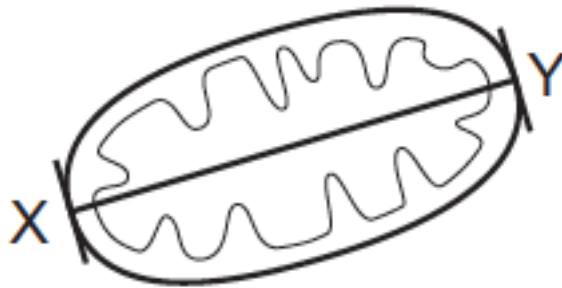

The length of the mitochondrion from X to Y is 3000 nm.

What is the magnification of the drawing of the mitochondrion?

- A X 200
- B X 2000
- C X 20000**
- D X 200000

5. The following figure shows the results of an experiment, in which, samples containing the same concentration of enzyme and substrate were kept at different temperatures for periods of one, two and five hours. The quantities of product formed were then determined.

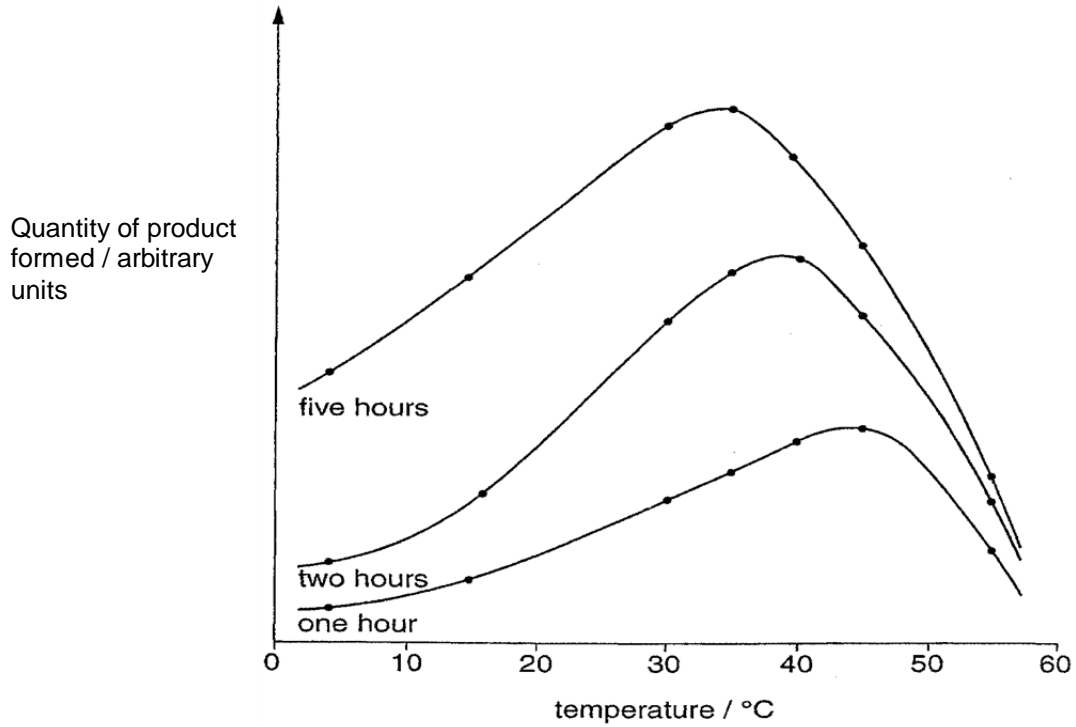

Which statement below does not describe the graphs?

- A** As temperature increased, the quantity of products formed increased.
- B** As the duration of the experiment decreased, the quantity of products decreased.
- C** The enzyme is not active at 50°C for when the experiment is carried out for five hours.
- D** Optimum temperature for the experiment held over one hour was highest as the enzyme had more disulfide bonds in stabilizing its structure.

6. The amount of DNA per nucleus in a mouse cell during a meiotic cell cycle, as shown below, was measured.

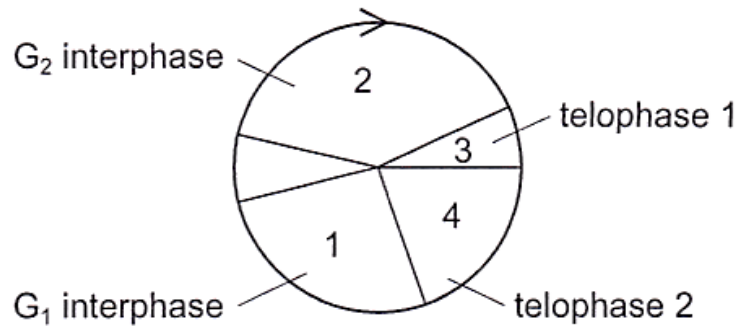

Which bar correctly represents the variation in DNA content?

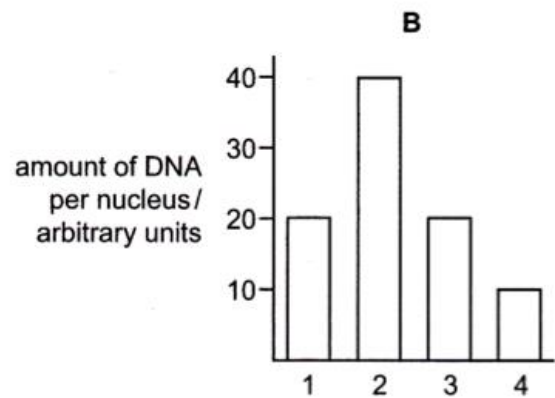
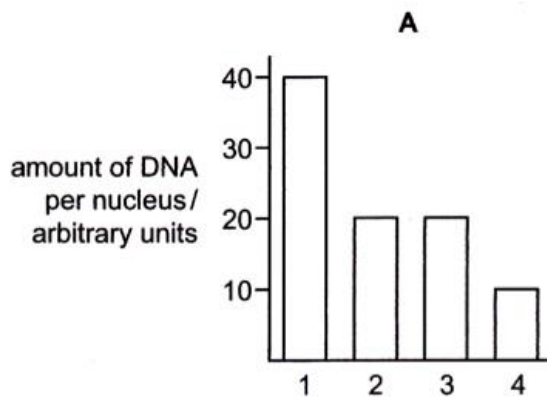

B

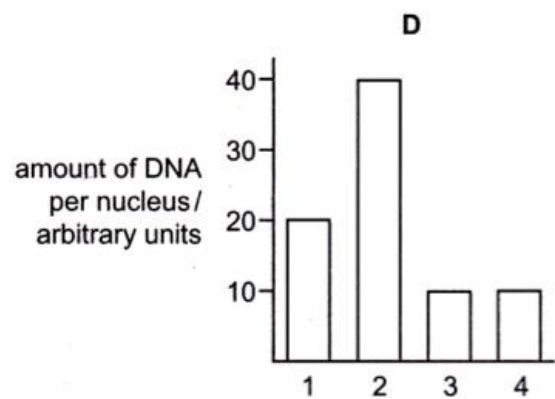
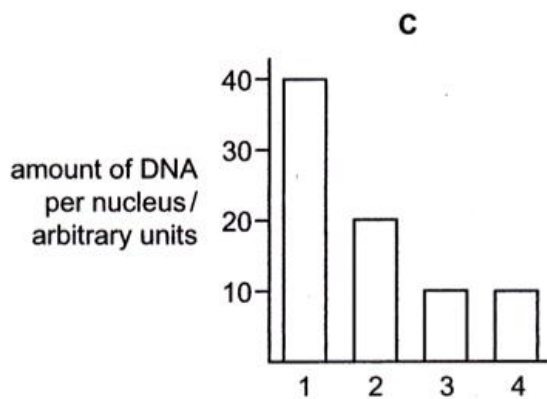

7. The diagram shows two homologous chromosomes in early prophase I of meiosis in a mouse cell. Two genes, A/a and B/b, whose loci occur on the homologous chromosomes are also shown.

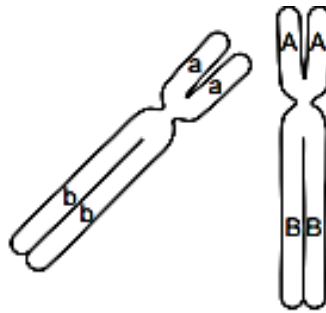

Which option is a possible representation of these chromosomes as they progress from anaphase I to prophase II?

	anaphase I	prophase II
A		
B		
C		
D		

D

8. The diagram shows a DNA template with the lagging strand prior to the removal of the RNA primers.

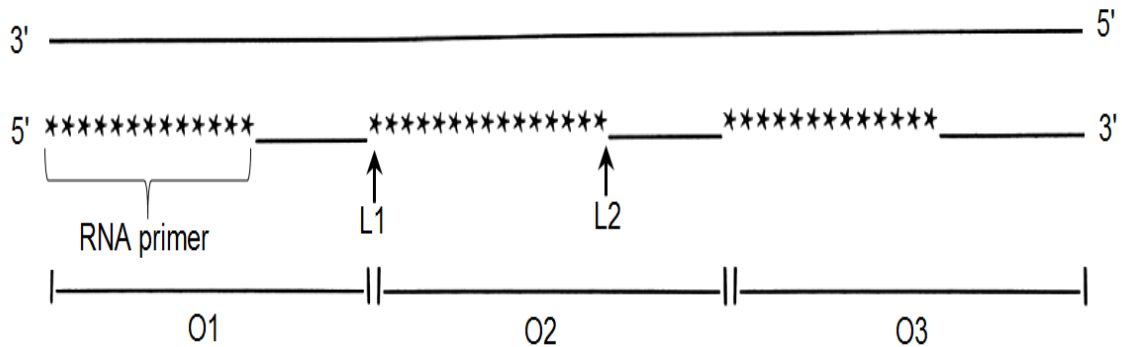

Which row correctly shows the events taking place during the synthesis of the lagging strand?

	First Okazaki fragment synthesised	Site of phosphodiester bond formation catalysed by DNA ligase
A	O1	L1
B	O1	L2
C	O3	L1
D	O3	L2

9. In a laboratory of Molecular Biology, the amino acids sequence of a cockroach intestine protein has been partially determined. The tRNA molecules used in the synthesis have the following anticodons:

3' UAC 5' 3' CGA 5' 3' GGA 5' 3' GCU 5' 3' UUU 5' 3' GGA 5'

What is the DNA nucleotide sequence of the non-template DNA strand?

- A** 5' ATG-GCT-GGT-CGA-AAA-CCT 3'
B 5' ATG-GCT-CCT-CGA-AAA-CCT 3'
C 5' ATG-GCT-GCT-CGA-AAA-GCT 3'
D 5' ATG-GGT-CCT-CGA-AAA-CGT 3'

10. A number of molecules other than tRNA and mRNA are involved during translation.

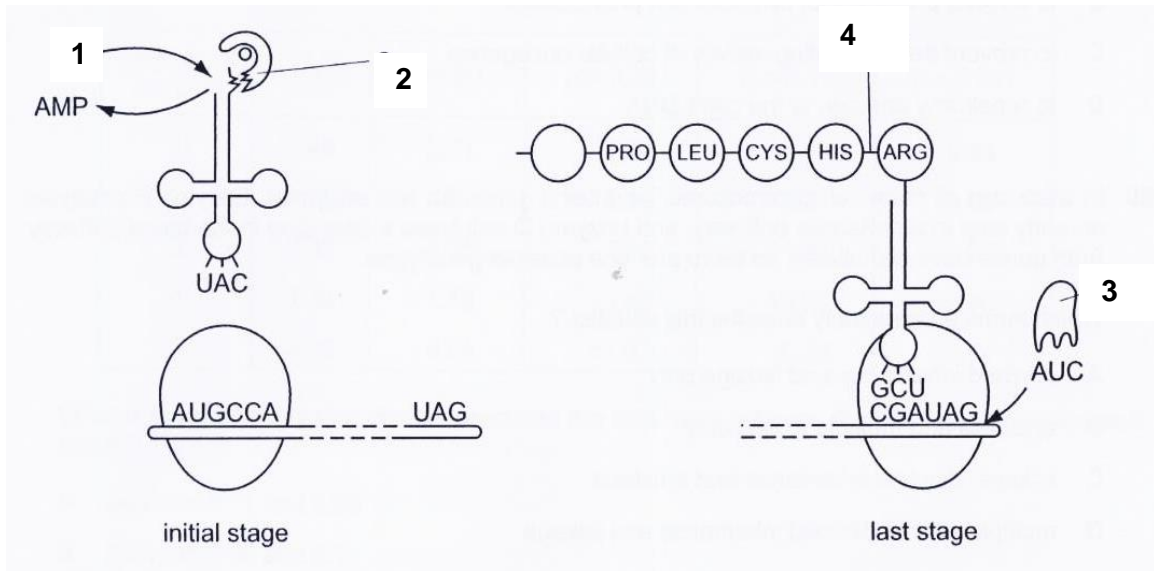

Which line in the table is correct for labels 1 – 4?

	1	2	3	4
A	ADP	Aminoacyl tRNA synthetase	Amino acid	Hydrogen bond
B	ADP	Amino acid	Release factor	Hydrogen bond
C	ATP	Aminoacyl tRNA synthetase	Release factor	Peptide bond
D	ATP	Amino acid	Aminoacyl tRNA	Peptide bond

11. Which of the following statements is true about prokaryotic plasmids?

- A** Plasmids replicate along with the chromosomal DNA by using chromosomal DNA as a template.
- B** Antibiotic-resistant genes on plasmids allow them to survive in antibiotic culture medium.
- C** Plasmid DNA strands run in opposite directions and the copy number varies with the type of plasmid.
- D** Binary fission ensures that plasmids are equally separated into daughter cells.

12. The globin gene family in humans consists of the α , β and γ genes. These genes code for the globin chains that make up haemoglobin and are expressed at different levels during different developmental stages.

The graph shows the expression of the various globin chains during the prenatal (fetal) and postnatal (after birth) periods.

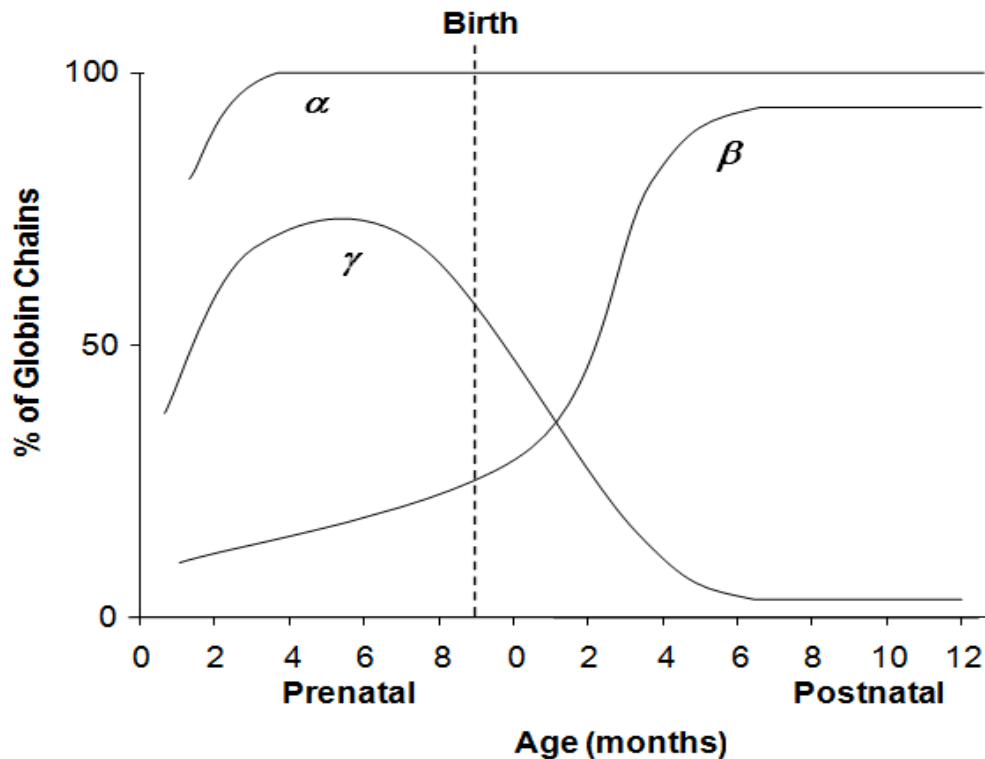

Which statement cannot account for the differences in the levels of expression of globin chains?

- A Methyl groups are added to regulatory sequences of γ -globin gene during the postnatal period, allowing for chromatin remodeling complexes to be recruited.
- B Alternative splicing occurs in the mature mRNA of the α -globin and β -globin genes, resulting in differences in the rate of expression of globin chains during the prenatal period.**
- C A growth factor triggers the expression of a transcription factor that increases the rate of β -globin gene expression during the postnatal period.
- D The shortening of poly(A) tail in the mRNA of γ -globin genes reduces its stability, resulting in a decrease in the rate of expression of γ -globin chains during the postnatal period

13. An analysis of the cells of a cancer patient revealed the presence of abnormal amounts of Ras proteins.

Which of the following could not explain for this observation?

- A Gene amplification of Ras proto-oncogene
 - B A point mutation in a control element of the Ras proto-oncogene
 - C Translocation of Ras proto-oncogene to a region under the control of a more active promoter
 - D A single substitution in the exon of Ras proto-oncogene**
14. A point mutation has occurred in *Escherichia coli*. Glucose and lactose are both absent in the culture medium where the mutant *E. coli* is grown in. An analysis of proteins synthesised by mutant *E. coli* found substantial amount of β -galactosidase, transacetylase and permease.

Which of the following mutations could have taken place in the *E. coli* cell?

- 1 Mutation in the operator of the lac operon
 - 2 Mutation in the *lacI* gene
 - 3 Mutation in the promoter of the lac structural genes
- A 1 only
 - B 2 only
 - C 1 and 2 only**
 - D 2 and 3 only

15. In an experiment to study genetic recombination, two strains of *Escherichia coli* with different nutritional requirements were used. Strain A ($met^- bio^- thr^+ leu^+ thi^+$) would grow on a minimal medium only if the medium were supplemented with methionine and biotin, while Strain B ($met^+ bio^+ thr^- leu^- thi^-$) would grow on a minimal medium only if it was supplemented with threonine, leucine and thiamine.

Some of the dishes were plated only with Strain A bacteria, some only with Strain B bacteria, and some with a mixture of Strain A and Strain B bacteria that had been incubated together for several hours in a liquid medium.

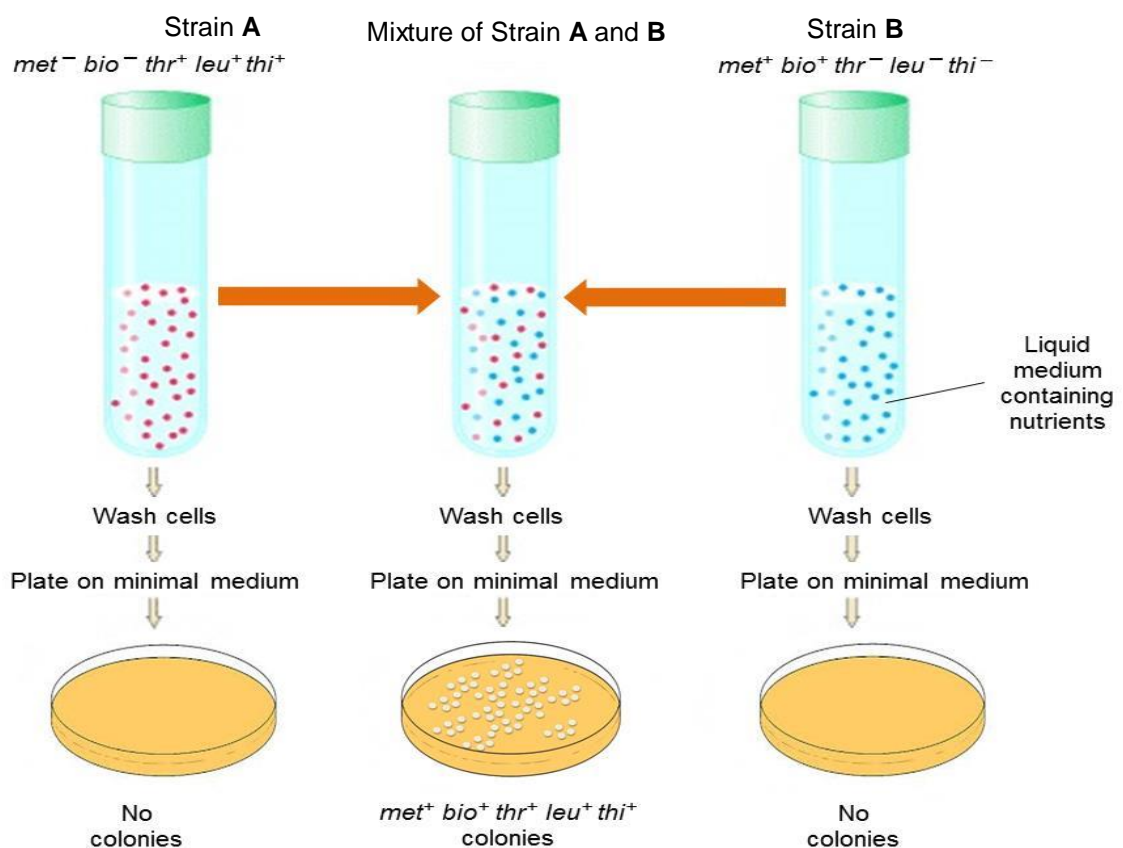

Which conclusion can be best drawn from the experiment?

- A** The thr^+ , leu^+ and thi^+ genes in Strain A are located in its F plasmid.
- B** Cell-to-cell contact is necessary for the exchange of alleles between strain A and strain B.
- C** All the five genes are located on the F plasmid.
- D** Mutations resulted in thr^+ , leu^+ and thi^+ genes in Strain B to produce colonies on a minimal medium plate.

16. The human immunodeficiency virus (HIV) has a highly specific gp120 glycoprotein that only allows it to infect cells with a CD4 receptor. To increase the host range of HIV in a laboratory setting, scientists often modify these viruses by artificially enclosing the viral nucleocapsid with a viral envelope with VSV-G glycoproteins embedded. VSV-G binds to LDL receptor, found ubiquitously on the cell membranes of many cell types, including kidney and liver cells that HIV do not usually infect.

A scientist has taken the following experimental steps:

1. Extracted an original and unmodified HIV nucleocapsid from wild-type HIV
2. Artificially enclose HIV nucleocapsid in a viral envelope containing VSV-G glycoproteins
3. Infect liver cells
4. Extract only newly synthesized virus particles released and examined them

What can the scientist expect to find in most newly synthesized virus particles extracted?

	Viral envelope	Viral Genome
A	VSV-G	VSV-G gene
B	VSV-G	gp120 gene
C	gp120	VSV-G gene
D	gp120	gp120 gene

17. During summer, an isolated population of bighorn ram on a mountain has been captured and the length of their curled horns was measured over 30 years. Horn length of bighorn ram follows a distribution similar to that of its weight.

Which of the following statements describing the features of horn length in bighorn sheep are not correct?

- 1 Horn length is controlled by multiple alleles with different degrees of dominance.
- 2 Horn length shows quantitative expression with overlaps between categories.
- 3 Horn length is polygenic where inherited individual alleles have an additive effect.
- 4 Horn length is not affected by the environment

A 1 and 2 only

B 1 and 4 only

C 2 and 3 only

D 3 and 4 only

18. Which of the following causes variation in both sexually and asexually reproducing organisms?

A Mutation

B Polygenic inheritance

C Crossing over

D Independent assortment

19. Possession of white or coloured feathers in chickens is controlled by two genes **P/p** and **Q/q**. The phenotypes of offspring that are expected from mating two chickens, each of which is heterozygous at both loci, are shown in the Punnett square.

Gametes	PQ	Pq	pQ	pq
PQ	White feathers	White feathers	White feathers	White feathers
Pq	White feathers	White feathers	White feathers	White feathers
pQ	White feathers	White feathers	Coloured feathers	Coloured feathers
pq	White feathers	White feathers	Coloured feathers	White feathers

What best explains the proportion of white to coloured feathers in the Punnett square?

- A** Dominant epistasis in which the epistatic allele is **P**
B Dominant epistasis in which the epistatic allele is **Q**
C Recessive epistasis in which the epistatic allele is **p**
D Recessive epistasis in which the epistatic allele is **q**
20. There are two hypotheses to explain the production of white, pale blue or dark blue flowers in a species of plant.

Hypothesis 1: There are two codominant alleles for flower color

Hypothesis 2: There are three alleles, one for each flower colour.

Which procedure is the best way of testing these hypotheses?

- A** Analysis of the flower pigments in several different flowers by chromatography to find whether some plants contain more than one pigment.
B Controlled cross pollination of all the different colour varieties available, in all possible combinations, and recording the colours shown by the offspring.
C Surveying large wild populations and finding the ratios of the different colours in these.
D Controlled self-pollination of several individuals of each of the colour varieties and recording the colours shown by the offspring of each individual plant sampled.

21. The following claims have been made about respiration.

- 1 Two turns of the citric acid cycle is required to oxidize 1 molecule of glucose.
- 2 Four molecules of carbon dioxide are generated for every molecule of acetyl CoA introduced into the Krebs Cycle.
- 3 During aerobic respiration, glucose produces pyruvate, CO₂ and ATP in the cytoplasm of a muscle cell.
- 4 Aerobic respiration can produce about 19 times the amount of ATP produced in anaerobic respiration.

Which of the following statements is/are true?

- A 1 only
- B 1 and 4 only**
- C 2 and 4 only
- D 1, 3 and 4 only

22. *Rafflesia arnoldii* is a parasitic plant that produces the world's largest flower. It survives by invading the underground roots of vines to absorb nutrients essential for polypeptide synthesis. By doing so, it makes use of the nutrients to develop a giant and stinking flower that smells of rotting flesh in order to attract pollinating flies.

Which of the following two factors are most likely to act as limiting factors and inhibit growth of the vines when the *Rafflesia* parasite is present?

- 1 Carbon dioxide
 - 2 Light
 - 3 Photosynthetic enzymes
 - 4 Water
 - 5 Temperature
- A 1 and 2
 - B 2 and 3
 - C 3 and 4**
 - D 4 and 5

23. Which of the following gives an accurate comparison between intracellular receptors and cell surface receptors?

	Intracellular receptors	Cell surface receptors
A	May act as regulatory proteins and bind to DNA	May catalyse the phosphorylation of intracellular proteins
B	Functions as the second messenger to activate other relay proteins	Binding of ligand always trigger the production of second messengers
C	Ligands can be water-soluble or lipid-soluble	Ligands must be lipid-soluble
D	Made up of only hydrophobic amino acids to allow the interaction with lipid-soluble ligands.	Made up of hydrophobic amino acids which interact with the phospholipids of the membrane

24. Which of the following statements about channel proteins is/are correct?

- I Channel proteins are either voltage-gated, ligand-gated or mechanically-gated.
- II Channel proteins do not undergo conformational changes when transporting molecules.
- III Channel proteins contain a hydrophilic pore lined with hydrophilic amino acids.
- IV Channel proteins serve to transport hydrophilic molecules of all sizes across the cell membrane.

- A I and II only
- B II and III only
- C I, II and III only**
- D All of the above

25. Concentrations of glycerate-3-phosphate (GP) and ribulose biphosphate (RuBP) were measured from samples of actively photosynthesising green algae in an experimental chamber.

Which of the following graphs show how the concentration of these compounds changes when the light source was turned off?

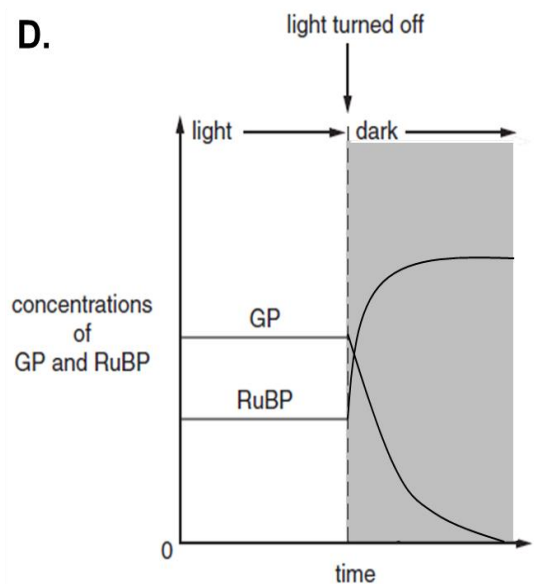
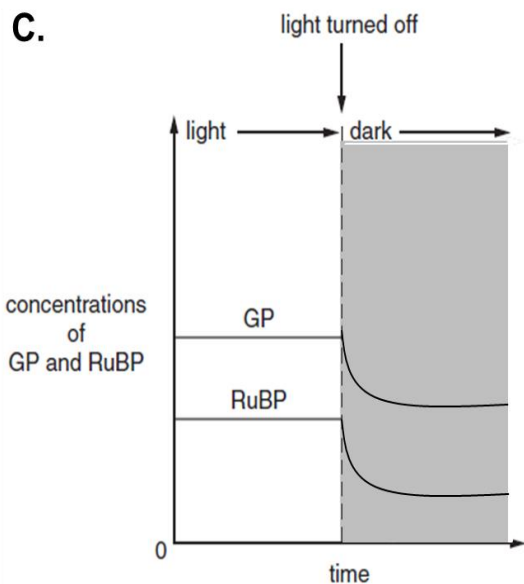
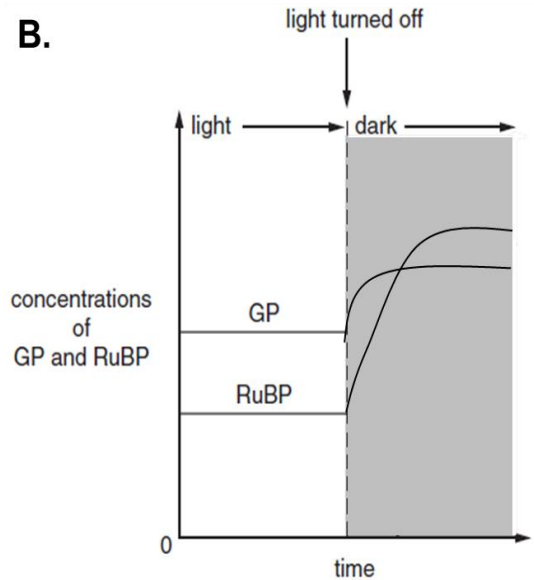
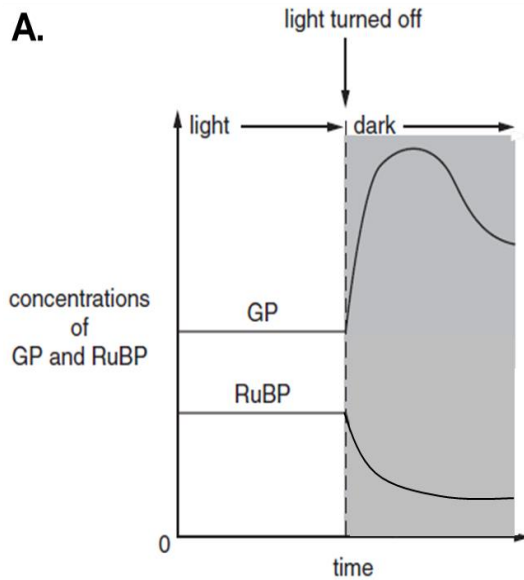

A

26. The following diagram shows the activation of the G protein-coupled receptor (GPCR) by the binding of adrenaline to the receptor. A mutation leads to constitutive signal transduction.

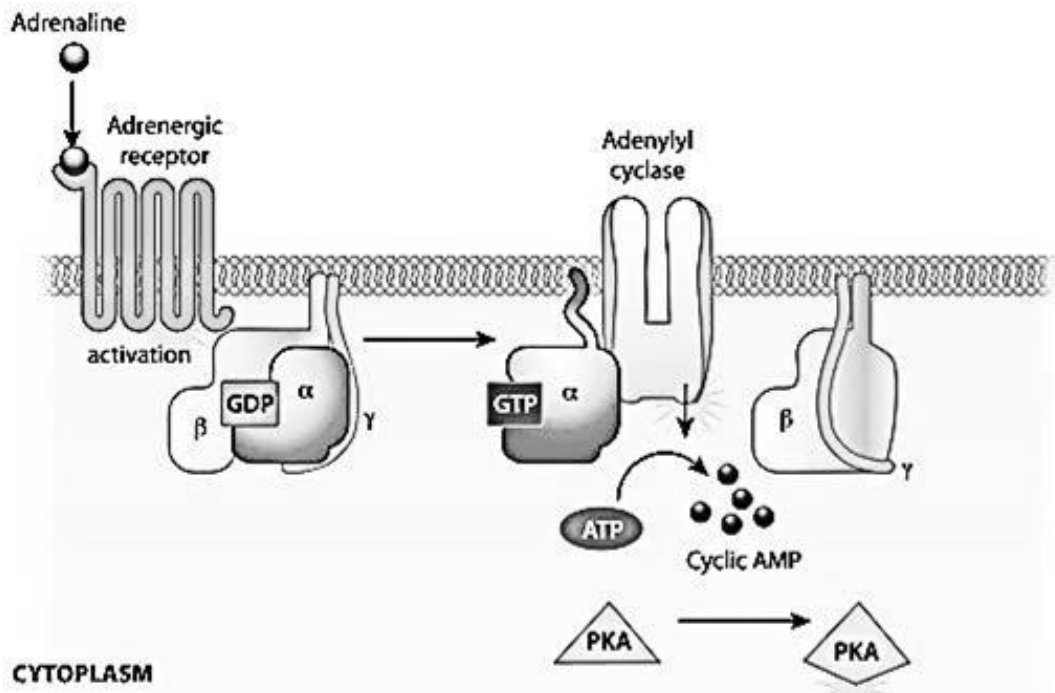

Which of the following is a possible result of the mutation?

- A Conformational change in adenylyl cyclase such that it cannot convert ATP to cyclic AMP.
- B Adrenaline not being able to bind to the receptor.
- C Cyclic AMP not being able to bind to PKA.
- D GTPase in G protein failing to hydrolyse GTP to GDP.**

27. The diagram below shows a normal action potential.

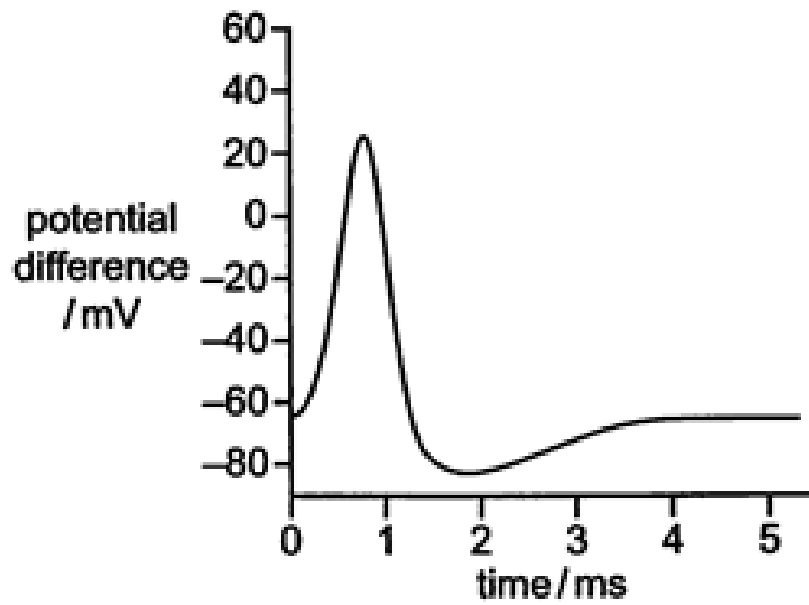

Drug X can bind and block voltage-gated K^+ channels.

Which of the following diagrams shows an action potential in a neurone affected by such a drug?

C

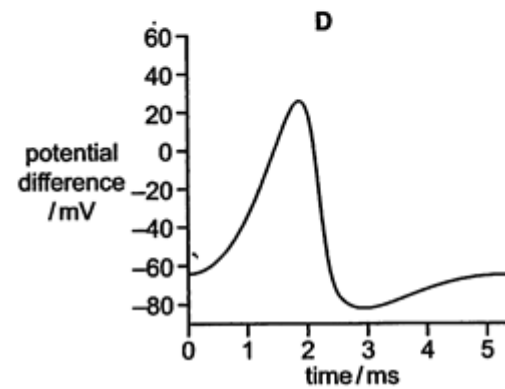
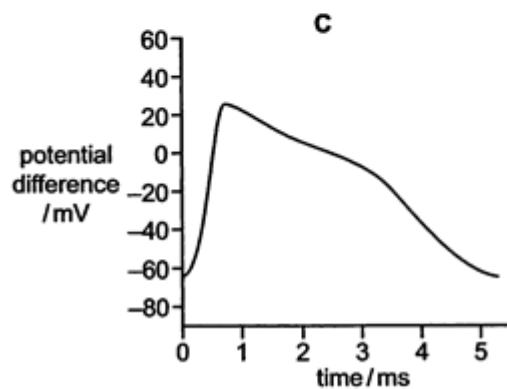
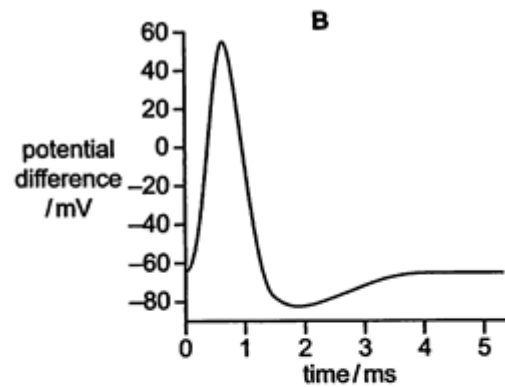
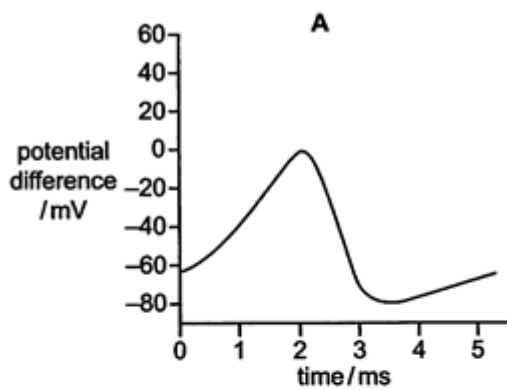

28. Which is a correct description of the role of calcium ions in synaptic signalling?
- A Calcium ions are moved in by diffusion through ligand gated ion channels in pre-synaptic membranes of excitatory neurons, causing vesicles to move towards the pre-synaptic membrane as an impulse arrives
 - B Calcium ions are moved in by diffusion through voltage gated ion channels in pre-synaptic membranes of excitatory neurons, causing vesicles to move towards the pre-synaptic membrane as an impulse arrives.**
 - C Calcium ions are moved in by active transport through calcium pumps in pre-synaptic membranes of excitatory neurons, causing vesicles to move towards the pre-synaptic membrane as an impulse arrives.
 - D Calcium ions are moved out by active transport through calcium pumps in pre-synaptic membranes of excitatory neurons, causing vesicles to move towards the pre-synaptic membrane as an impulse arrives.

29. The production of testosterone is regulated by the anterior pituitary gland. Upon stimulation by hormone K, the gland releases hormone L which causes the testes to produce testosterone. The elevated level of testosterone exerts a negative feedback on the anterior pituitary gland.

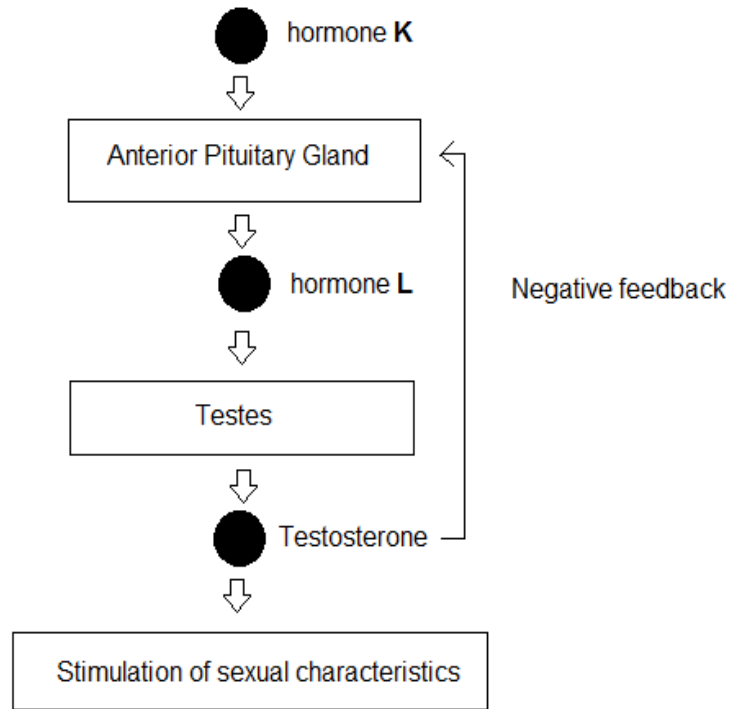

Which of the following would be observed if a man consumes large amount of steroids containing testosterone?

	Production of hormone K	Production of hormone L	Production of testosterone	Stimulation of sexual characteristics
A	Decrease	Decrease	Decrease	No change
B	Decrease	Decrease	No change	Increase
C	No change	Decrease	Decrease	Increase
D	No change	Decrease	Decrease	No change

30. Which of the following is not a limitation of the use of fossil records as evidence for evolution?
- A Fossils are damaged and incomplete.
 - B Some organisms may not form fossils.
 - C Fossils are found in different sedimentary rock layers.**
 - D Fossils present in inaccessible areas are not available to us for study.
31. The following statements relate to molecular phylogenetics.
- 1 Lines of descent from a common ancestor to present-day organisms have undergone similar and fixed rates of DNA mutation.
 - 2 Organisms with similar base sequences in their DNA are closely related to each other.
 - 3 The number of differences in the base sequences of DNA of different organisms can be used to construct evolutionary trees.
 - 4 The proportional rate of fixation of mutations in one gene relative to the rate of fixation of mutations in other genes stays the same in any given line of descent.

Which statements, when taken together, suggest the existence of a 'molecular clock' that enables scientists to estimate the time at which one species might have diverged from another?

- A 1 and 2 only
- B 1 and 4 only**
- C 2 and 3 only
- D 3 and 4 only

32. The northern elephant seal almost became extinct in the late 1800's following harvesting by whalers and sealers for their blubber which contains oil. A small colony of between 20 and 100 individuals survived on Guadalupe Island off Baja California. This colony has since given rise to about 160,000 elephant seals on the Pacific coast today. The following figure compares the distribution of elephant seals between 1900 and 2005.

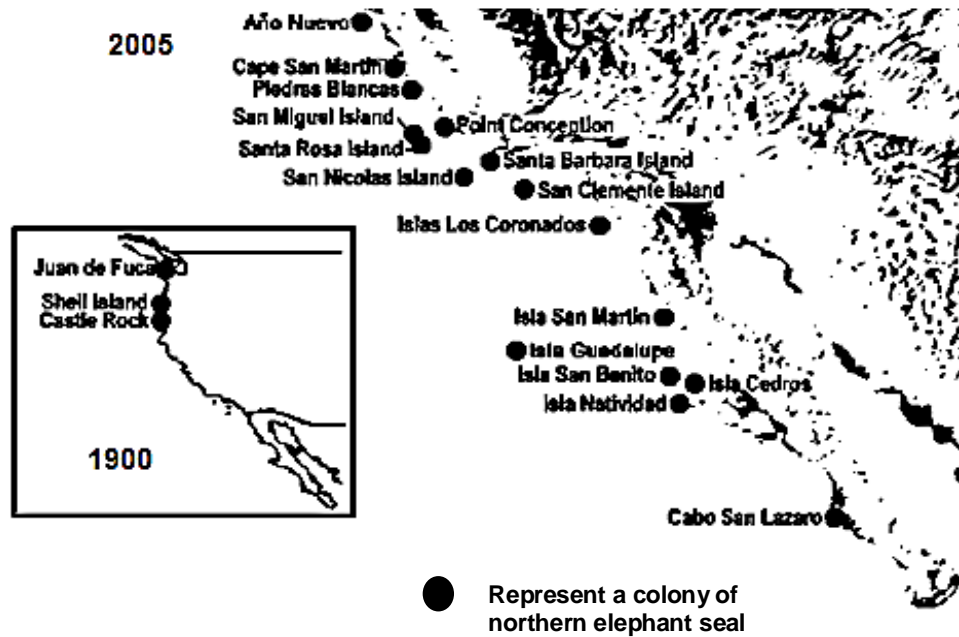

Which evolutionary mechanism could best explain why the degree of homozygosity is higher in the recent population of elephant seals compared to the original population in the 1800s?

- A Directional selection
- B Bottleneck effect**
- C Founder effect
- D Genetic drift

33. The soapberry bug, *Jadera haematoloma*, uses its long beak to penetrate the fleshy fruit of the native soapberry tree to feed on the seeds at the centre. The bug also feeds on the fruit of the introduced golden rain tree.

Investigators measured the beak length of the soapberry bugs over eighty years. The results are shown in the graph.

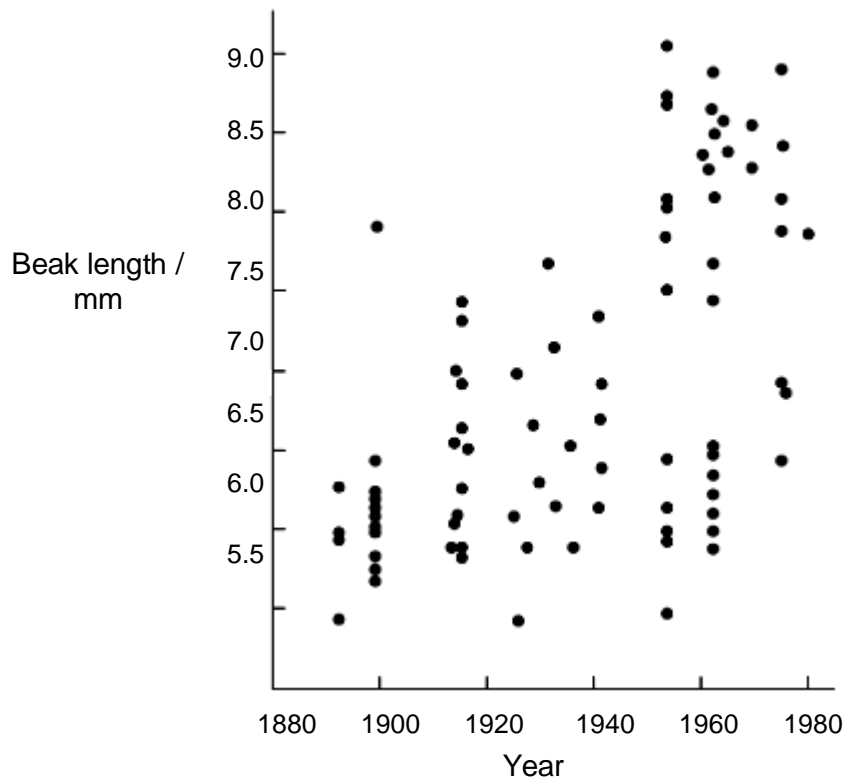

Which of the following statements is a reasonable conclusion based on the above information?

- A The golden rain tree was introduced around 1970.
- B The change in beak length is an example of stabilizing selection.
- C The diameter of the golden rain tree fruit acted as a selection pressure on beak length.**
- D The response of an individual golden rain tree to predation by soapberry bugs would be to grow larger fruit.

34. EcoRI is a restriction enzyme produced by *Escherichia coli*. It recognises the sequence GAATTC and is able to make a staggered cut in the DNA. *E. coli* is susceptible to attack by bacteriophages.

Which of the following correctly describes the natural function of EcoRI?

- A** It lowers infectivity rate of *E. coli* by bacteriophages that have double-stranded DNA as their genetic material, since EcoRI can recognise and cleave specific viral nucleotide sequences.
- B** It cleaves *E. coli* DNA sequences to produce restriction fragments that can be packaged into bacteriophages for infection of new bacterial cells.
- C** It increases infectivity rate of *E. coli* by bacteriophages because it promotes cleavage of viral DNA at specific nucleotide sequences in order to package more viral DNA into new virus particles.
- D** It cleaves *E. coli* DNA sequences so that the bacterial cell which has been infected will undergo autolysis and self-destruct, preventing further infection of new bacterial cells.

35. Menkes' syndrome in humans is characterised by sparse and wiry hair, growth failure and deterioration of the nervous system. Onset of the Menkes' syndrome usually occurs during infancy.

A family, in which this X-linked disorder was present, underwent Restriction Fragment Length Polymorphism (RFLP) analysis using gel electrophoresis. The family pedigree is shown below.

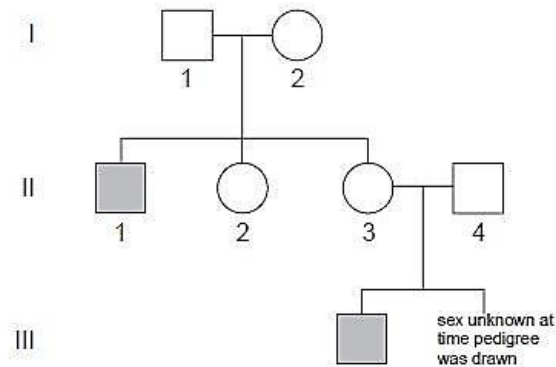

The RFLP analysis resulted in the following distribution of bands in the gel.

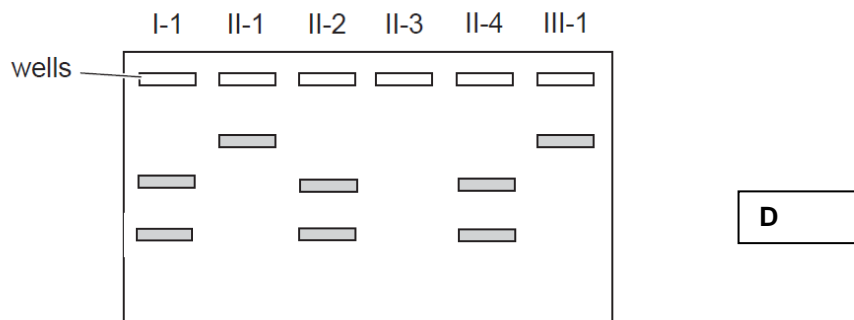

What would be the band pattern of individual II-3?

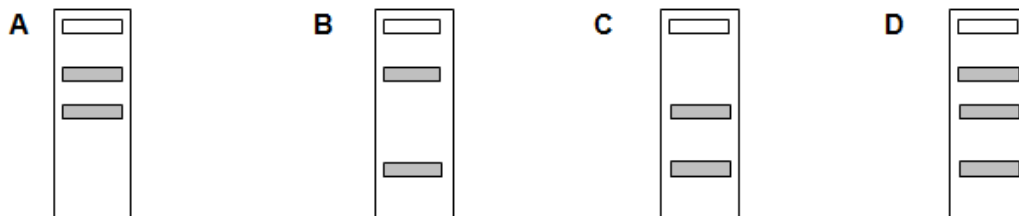

36. Which of the following options correctly describe the events occurring in each process?

	Action of restriction enzyme	Ligation	Annealing	Denaturation
A	Breaking of hydrogen bonds	Formation of hydrogen bonds	Formation of phosphodiester bonds	Breaking of phosphodiester bonds
B	Breaking of hydrogen bonds	Formation of hydrogen bonds	Formation of phosphodiester bonds	Formation of phosphodiester bonds
C	Breaking of phosphodiester bonds	Formation of phosphodiester bonds	Formation of hydrogen bonds	Breaking of hydrogen bonds
D	Breaking of phosphodiester bonds	Formation of phosphodiester bonds	Breaking of hydrogen bonds	Formation of hydrogen bonds

37. Which of the following are ethical concerns arising from the Human Genome Project?

- 1 Scientists tracing migration of different population groups based on maternal inheritance
- 2 Genetic counsellors giving advice to people who are genetically pre-disposed to risks
- 3 Parents choosing to abort foetuses with minor disorders based on genetic testing results
- 4 Scientists developing tests for only some disease-causing genes.
- 5 Employers refraining from hiring people with greater risk of developing genetic diseases

A 1 and 4

B 2 and 5

C 3 and 4

D 3 and 5

38. Which of the statements about stem cells are false?

- 1 Embryonic stem cells are useful as they have the ability to differentiate into any cell type.
- 2 Embryonic stem cells are less easily isolated compared to neural crest stem cells.
- 3 Umbilical cord blood stem cells have the same developmental potential as neural crest stem cells.
- 4 Induced pluripotent stem cells undergo differentiation to give rise to various cell lineages.
- 5 Stem cells have the ability to self-renew without any stimulus.

A 1, 2 and 5 only

B 1, 4 and 5 only

C 2, 3 and 4 only

D 3, 4 and 5 only

39. One way to treat β -thalassaemia is to transplant bone marrow cells from a genetically compatible donor into a patient. A potential gene therapy involves adding the normal and dominant allele for β -globin to the patient's cells.

What would ensure that the normal gene is passed on to the next generation?

- A Using a retrovirus to introduce the normal β -globin gene into bone marrow cells.
- B Using an adenoviral vector to introduce the normal β -globin gene into bone marrow cells.
- C Using an adenoviral vector to introduce the normal β -globin gene into an egg cell.
- D Using a retrovirus to introduce the normal β -globin gene into an egg cell.**

40. Which of the following is an example of genetically modified organisms?
- A Cows that grow to adult sizes quickly due to injection of recombinant bovine somatotropin
 - B Durians that ripen slower due to anti-sense technology**
 - C High yielding rice that are flood resistant, due to intensive self-pollination over generations
 - D Cows that grow to abnormal size due to inbreeding

End Of Paper

Candidate Name: _____

--	--

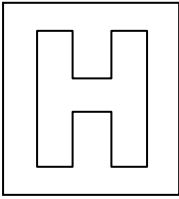

2016 Preliminary Examination II Pre-University 3

H2 Biology**9648/02**

Paper 2 Core Paper

16 September 2016**2 hours**

Additional Materials: Writing paper

READ THESE INSTRUCTIONS FIRST**Do not open this booklet until you are told to do so.**

Write your Admission number and name on all the work you hand in.
Write in dark blue or black pen on both sides of the paper.
You may use a soft pencil for any diagrams, graphs or rough working.
Do not use staples, paper clips, highlighters, glue or correction fluid.

Section AAnswer **all** questions.**Section B**Answer any **one** question.

At the end of the examination, fasten all your work securely together.
The number of marks is given in brackets [] at the end of each question or part question. At the end of the examination, fasten all your work securely together.

For Examiner's Use	
Section A	
1	
2	
3	
4	
5	
6	
7	
Section B	
Total	

This question paper consists of 28 printed pages.

[Turn over

Section A

Answer **all** questions in this section.

- 1. Figure 1.1 shows a mid-section of a mammalian DNA molecule, comprising Strand A and Strand B, during the S phase of interphase.

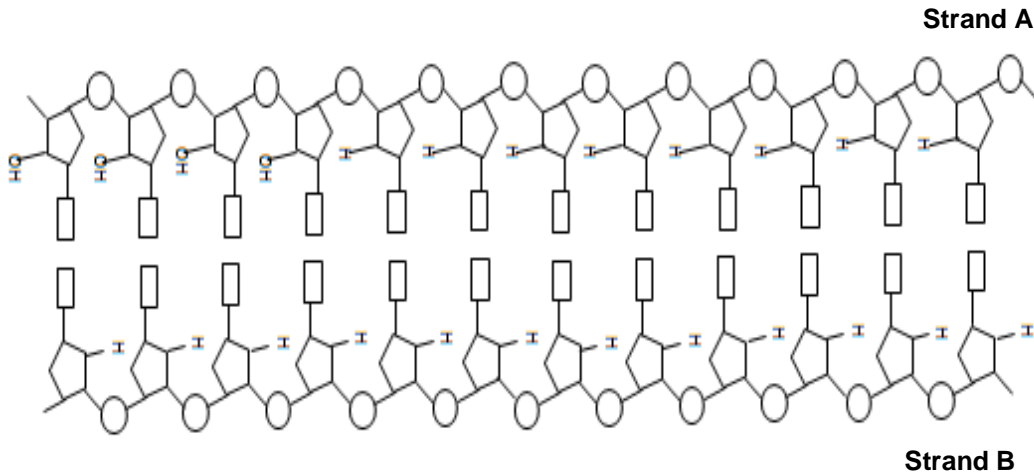

Figure 1.1

- (a) With reference to Figure 1.1,
 - (i) account for the difference in the nucleotides in Strand A compared to Strand B.

.....

 [3]

- (ii) Outline the next immediate step in the further processing of Strand A.

.....

 [1]

Figure 1.2 depicts a telomere complex at the end of a chromosome in a human zygote. Telomeres are lengthened during embryonic development to compensate for shortening due to the end-replication problem.

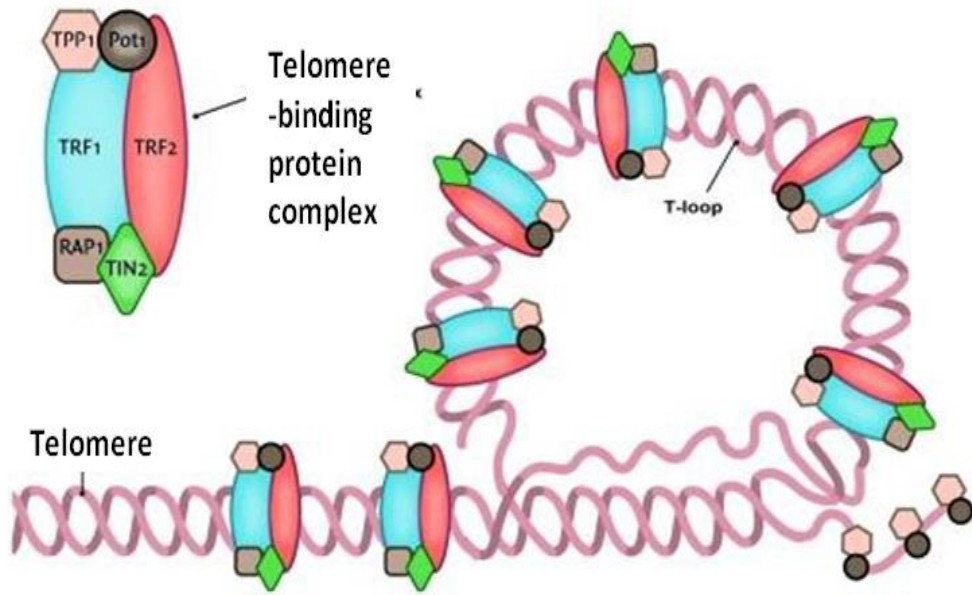

Figure 1.2

(b) Describe two differences between transcription and the process of telomere lengthening.

.....

.....

.....

..... [2]

A study was conducted to investigate gene expression in yeast. Yeast strain **X** and strain **Y** were used in this study. These strains differed in the location of the *ADE2* gene. In strain **X**, *ADE2* gene is at its normal locus on chromosome 5. An engineered inversion event is responsible for creating strain **Y** where *ADE2* gene locus is near the telomere. Figure 1.3 depicts the loci of the *ADE2* gene in both strain **X** and strain **Y**.

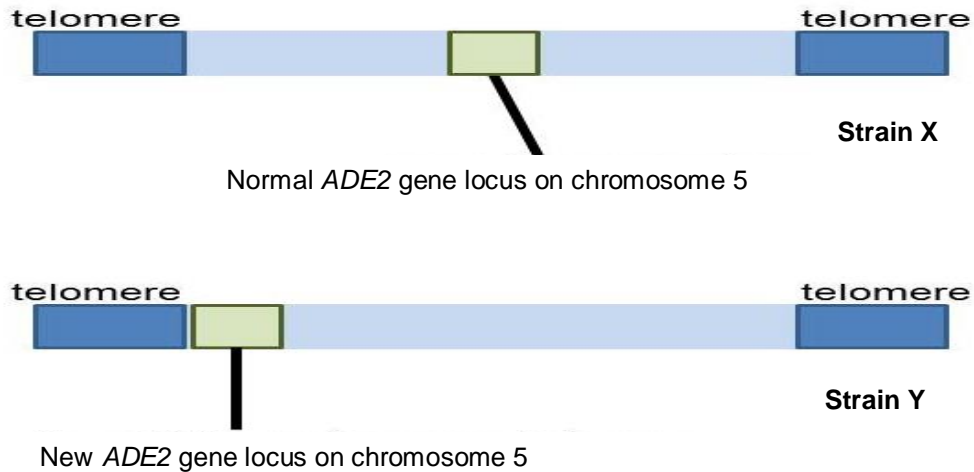
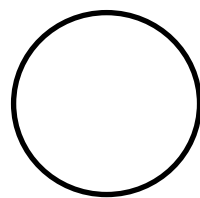
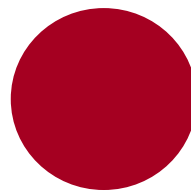

Figure 1.3

The above yeast strains were cultured on specially supplemented agar plates and incubated for one week to produce yeast colonies. Based on the constituents of the agar, expression of *ADE2* gene prevents accumulation of red pigments and results in cells being white in colour. The colonies produced from this period of incubation are represented in Figure 1.4.



White Colonies
from Strain **X**



Red Colonies from
Strain **Y**

Figure 1.4

Previous studies have shown that some proteins bind to yeast telomeres to recruit histone deacetylase enzymes. These enzymes then act on the chromatin regions around the telomeres.

- (c) Using the above information, explain the difference in colony colour between strain X and strain Y after one week of incubation.

.....
.....
.....
.....
.....
..... [4]

The colonies from both strains were allowed incubate for an additional week. Following this, it is then observed that some cells at the edges of the Strain Y colonies appeared white in colour, as depicted in Figure 1.5.

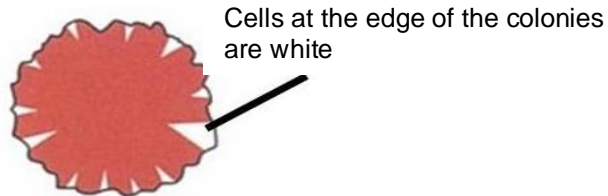

Appearance of colonies from Strain Y after two weeks of incubation

Figure 1.5

- (d) Explain why the cells at the edges of Strain Y colonies appear white in colour after two weeks of incubation.

.....
.....
.....
.....
..... [3]

[Total: 13]

- 2. In the cytosol, chaperone proteins can bind reversibly to newly synthesized polypeptides and shield them from other molecules. This prevents the R groups of amino acids from forming bonds with the wrong molecular partners, hence allowing the polypeptides to fold correctly.

Figure 2.1 below shows how chaperone proteins work.

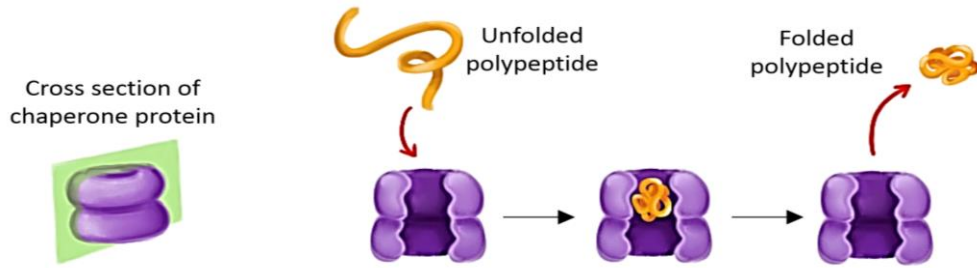

Figure 2.1

- (a) With reference to Figure 2.1, explain how chaperone proteins regulate gene expression.

.....

 [2]

- (b) Describe how cytosolic proteins are degraded in cells.

.....

 [2]

When a protein fails to fold correctly upon synthesis or misfolds at a later stage in its cellular life time, it can no longer fulfil its biological function. Protein misfolding may occur due to mutations in genes or interference with expression of chaperone proteins. Figure 2.2 shows how misfolded proteins may aggregate in a cell.



Figure 2.2

(c) With reference to Fig. 2.2, suggest why misfolded proteins tend to aggregate in the cell.

.....

.....

..... [2]

An example of a misfolding disease is Bovine spongiform encephalopathy (BSE), a neurodegenerative disease in cattle and commonly referred to as mad cow disease. In BSE, there is an aggregation of misfolded prion proteins in the neurons of cattle, which results in degeneration of the brain and spinal cord.

Hereditary forms of BSE have been associated with a mutation in the brain prion protein (PrP) gene, which encodes the PrP protein. The PrP protein is a transmembrane glycoprotein found on the surface of neurons. Figure 2.3 shows the ribbon model of a normal PrP protein.

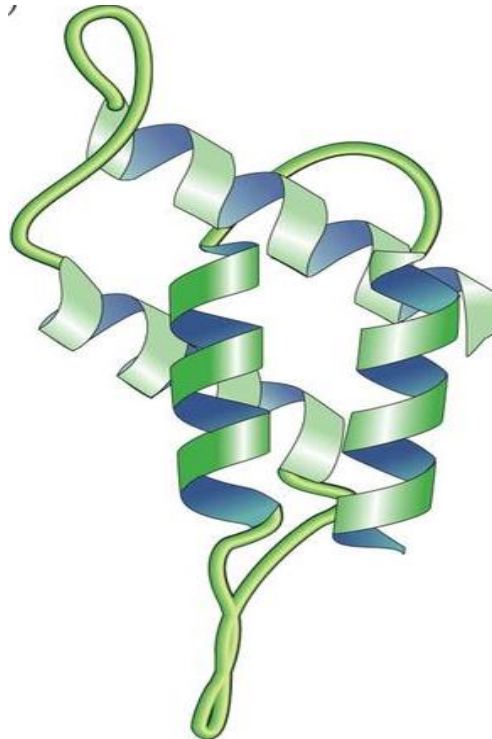

Figure 2.3

- (d) Explain how the the PrP protein would maintain its position within the cell membrane.

.....

.....

..... [2]

- (e) Describe how the PrP protein on the cell surface membrane is formed after its polypeptide chain has been synthesized.

.....

.....

.....

.....

.....

.....

.....

..... [4]

A human version of BSE called variant Creutzfeldt-Jakob disease (vCJD) is believed to be caused by eating beef products contaminated with central nervous system tissue from infected cattle. Studies have shown that the introduction of misfolded cattle PrP by consuming contaminated meat can cause normal human prion protein to misfold and form aggregated plaques in the brain.

Health advisories have cautioned that cooking contaminated meat will not provide protection from infection that would lead to vCJD.

- (f) Suggest why cooking contaminated meat products will not provide protection from contracting vCJD.

.....

..... [1]

[Total: 13]

3. Burmese cats, *Felis catus*, show discontinuous variation in the colour of their eyes and hearing ability. A large scale investigation was conducted to study the inheritance pattern of eye colour and deafness in such cats.

Pure-breeding blue eyed cats which were deaf were crossed with pure-breeding yellow eyed cats with normal hearing.

The F₁ all had yellow eyes and normal hearing.

Female cats from the F₁ were crossed with male cats with blue eyes and were deaf. 668 offspring were produced.

The observed numbers of F₂ cats with each phenotype were as follows:

Blue eyes, deaf	259
Blue eyes, normal hearing	72
Yellow eyes, deaf	53
Yellow eyes, normal hearing	284

- (a) State what is meant by pure-bred cats for eye colour and hearing ability.

.....
 [1]

A chi-squared test, with the guide of Table 3.1, was planned to evaluate the difference between observed and expected results.

Table 3.1

Degree of Freedom	Probability, p				
	0.10	0.05	0.02	0.01	0.001
1	2.71	3.84	5.41	6.64	10.83
2	4.61	5.99	7.82	9.21	13.82
3	6.25	7.82	9.84	11.35	16.27
4	7.78	9.49	11.67	13.28	18.47

- (b) Based on this study, state the expected results for F₂ cats produced from crossing F₁ female cats with male cats with blue eyes and were deaf.

..... [1]

- (c) With reference to Table 3.1, outline how the significance of the difference between observed and expected results can be evaluated with 98% confidence (Formulae not required).

.....

.....

.....

.....

..... [2]

The difference between observed and expected results was eventually concluded to be significant.

- (d) Using the symbols Y/y for eye colour and H/h for hearing ability, draw a genetic diagram to explain the observed results of the cross between F₁ female cats and male cats with blue eyes and were deaf.

[4]

The coordinated activity of higher order organisms like cats relies upon a continuous input of information from the internal and external environments. Information is in the form of stimuli, which are detected by receptors. One such receptor is called a Pacinian corpuscle, which is found in the skin.

Fig. 3.1 shows the electrical activity recorded by two microelectrodes inserted into:

- the axon within the Pacinian corpuscle at site **P**, and
- the axon of the sensory neurone leaving the corpuscle at site **Q**

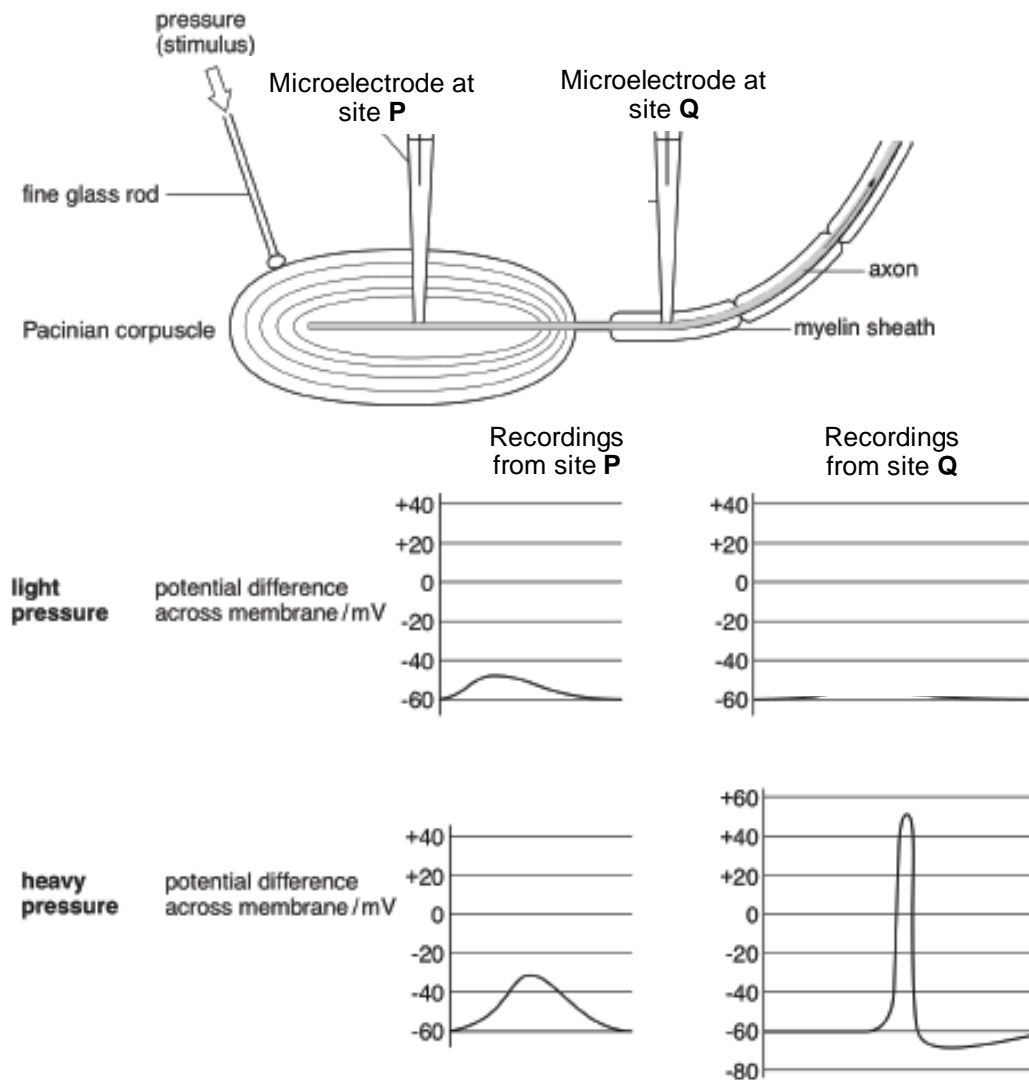

Figure 3.1

- (e) With reference to Figure 3.1, account for the changes in electrical activity in site **P** and **Q** as increasing pressure is applied to the Pacinian corpuscle.

.....

.....

.....

.....

.....

.....

.....

.....

.....

.....

..... [4]

[Total: 12]

4. Rhinoviruses are the most common viral infectious agents in humans and are the predominant cause of the common cold. Symptoms include sore throat, runny nasal congestion, sneezing and cough which may be accompanied by muscle aches and loss of appetite.

The structure of the human rhinovirus is depicted in Figure 4.1. Human rhinoviruses are composed of a capsid that contains four viral proteins **VP1**, **VP2**, **VP3** and **VP4**. Each virion has one copy of single-stranded positive sense RNA genome of between 7200 and 8500 nucleotides in length.

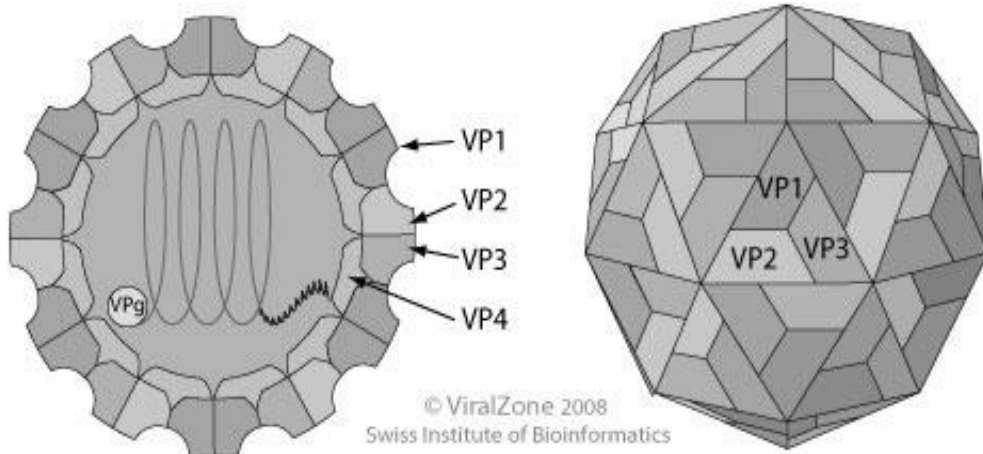

Figure 4.1

Despite structural differences, both human rhinovirus and influenza virus are able to penetrate respiratory epithelial cells for infection.

- (a) Explain how it is possible for both human rhinovirus and influenza virus to be able to penetrate human respiratory epithelial cells.

.....

 [1]

The enzyme neuraminidase plays an important role after new influenza virions exit their host cells from each round of infection.

- (b) Describe the role of neuraminidase in the reproductive cycle of the influenza virus.

.....

 [2]

- (c) With reference to Figure 4.1, explain why it is unlikely that the newly assembled human rhinovirus exit their host cells in the same way as influenza virions.

.....

.....

..... [2]

H7N9 is a subtype of Avian Influenza virus, which normally circulates amongst the avian populations with some variants known to occasionally infect humans. An H7N9 virus was first reported to have infected humans in 2013 in China and now this virus has spread among humans. Figure 4.2 shows the proposed evolution of H7N9 virus.

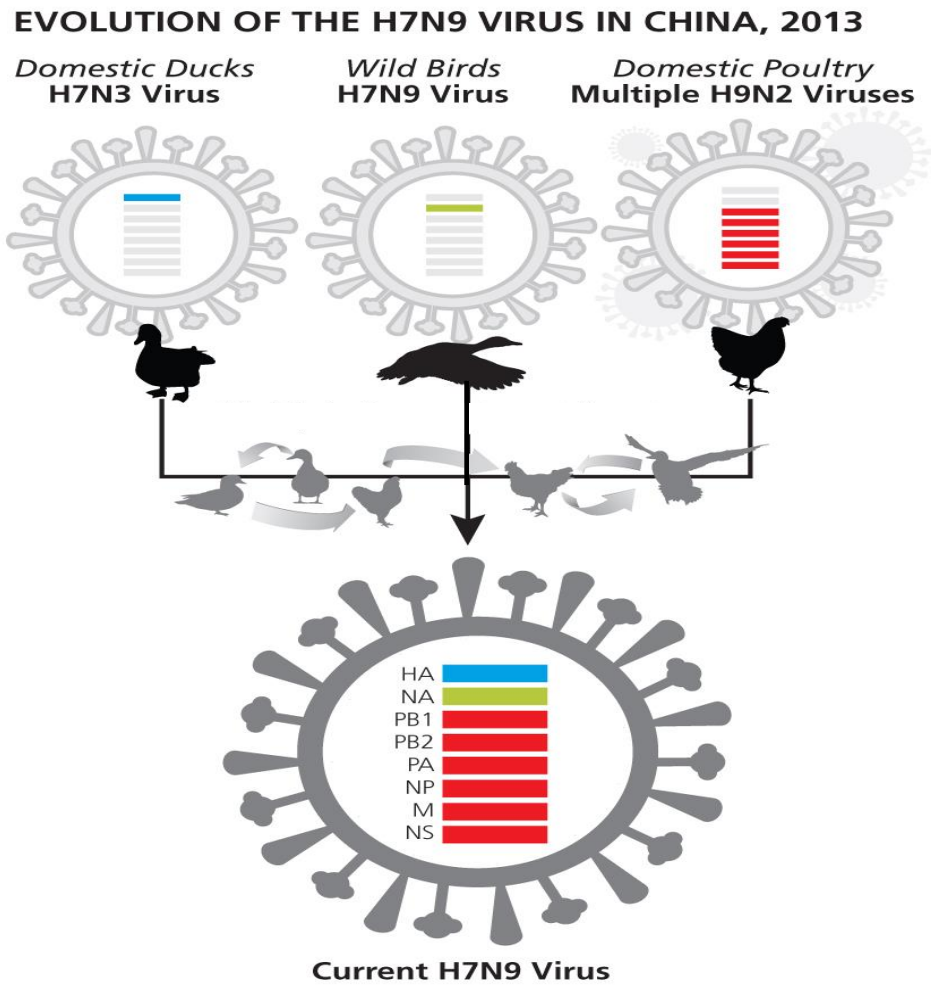

Figure 4.2

(d) With reference to Figure 4.2, explain how the new combination of RNA segments in H7N9 was proposed to have arisen.

.....

.....

.....

.....

..... [3]

Today viruses are considered an exception to the cell theory which states that the basic units of life are cells. Viruses have been referred to as “organisms at the edge of life”.

(e) State one characteristic of viruses that may classify them as being

(i) living

.....
..... [1]

(ii) non-living

.....
..... [1]

[Total: 10]

5. A study was carried out to measure the concentrations of glucose and insulin in the blood of students. The results are summarised in Fig. 5.1.

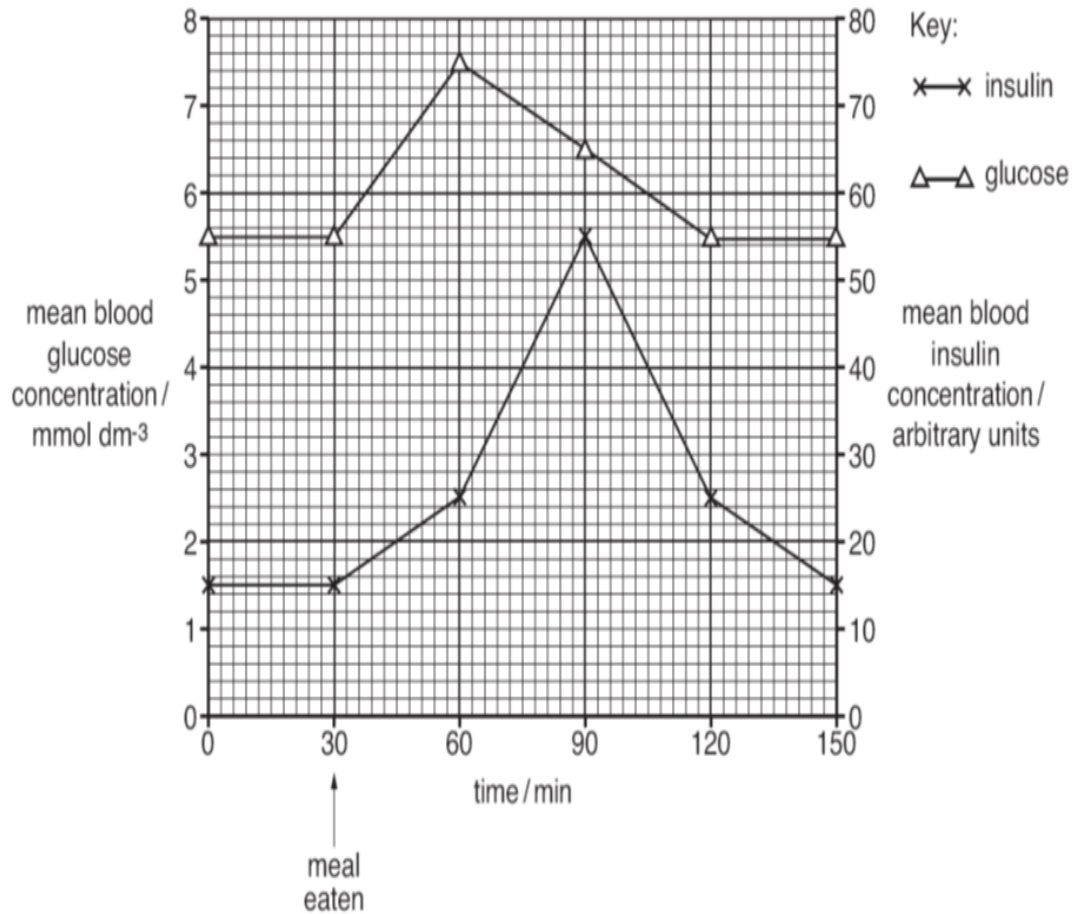

Figure 5.1

- (a) With reference to Figure 5.1, account for the relationship between the concentration of glucose and the concentration of insulin in the blood after a meal.

.....

.....

.....

.....

.....

.....

.....

.....

..... [5]

Figure 5.2 outlines some steps in glucose metabolism in human muscle cells.

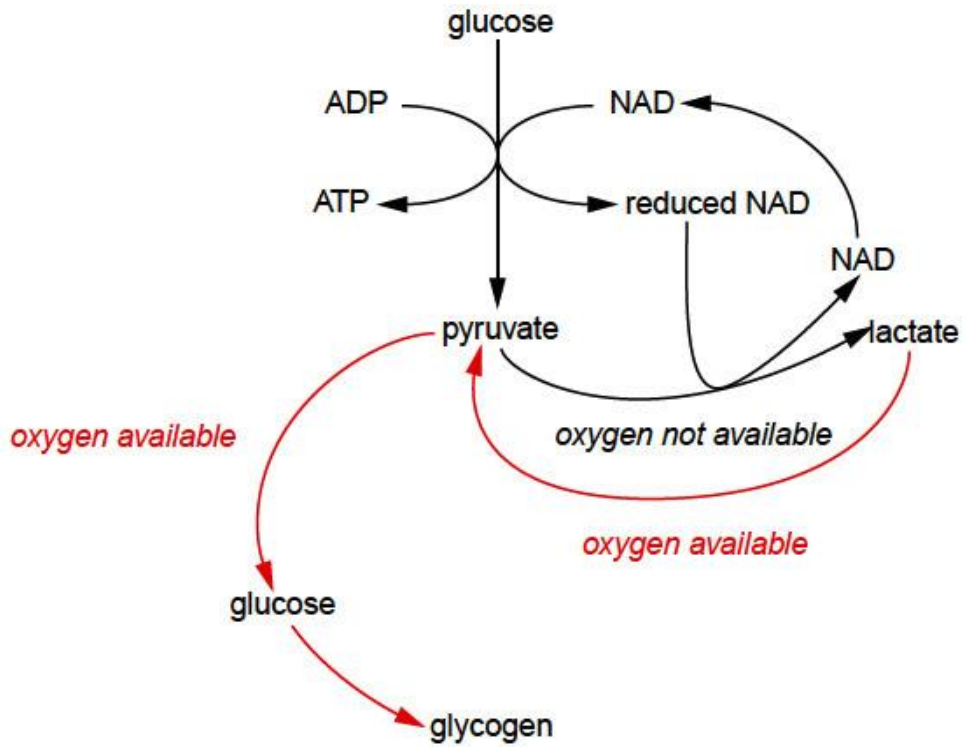

Figure 5.2

(b) Explain why pyruvate needs to be converted to lactate in the absence of oxygen.

.....

.....

.....

..... [2]

Hexokinase is an enzyme that plays a critical role in glucose metabolism. This enzyme converts glucose into glucose-6-phosphate. This step is important as it energises glucose for further metabolic reactions. Fig. 5.3 is a computer-generated image of the enzyme hexokinase binding with its substrate, glucose.

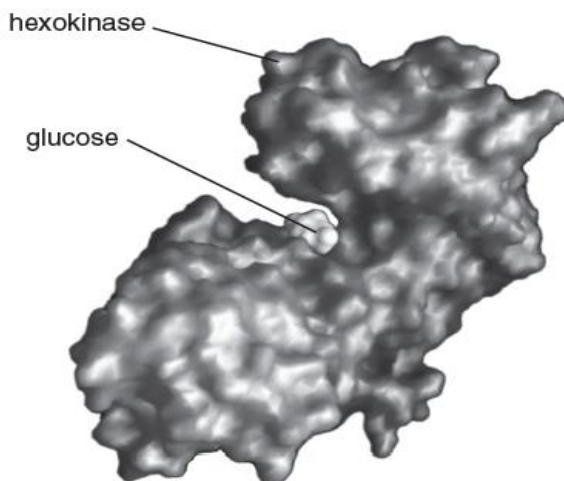

Figure 5.3

Crystallization studies have shown that the shape of hexokinase's active site is not complementary to the shape of glucose.

(c) Describe the mechanism by which hexokinase binds to glucose.

.....

.....

.....

..... [2]

The phosphorylation of glucose by hexokinase also prevents it from leaving the liver cells.

(d) Suggest why glucose-6-phosphate cannot move out of liver cells.

.....

.....

..... [2]

[Total: 11]

6. Most ATP is made in cells by membrane systems that create proton gradients by pumping protons from one compartment to another. Figure 6.1 show two such organelles.

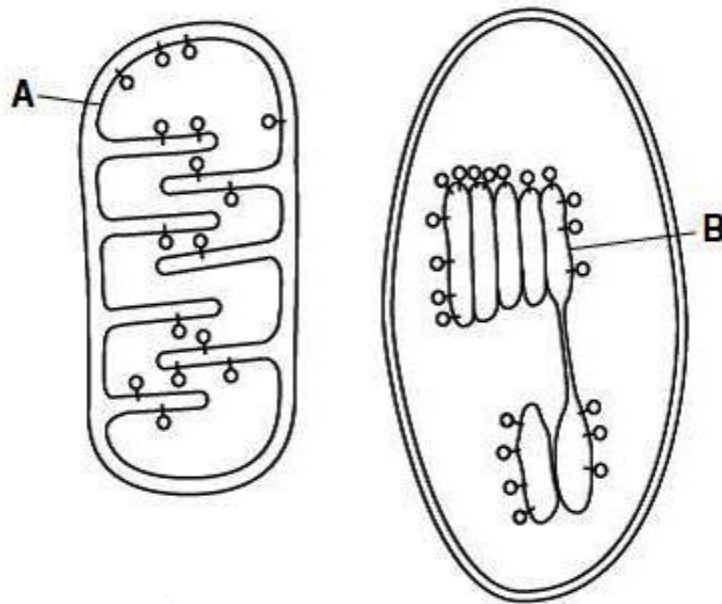

Figure 6.1

- (a) Draw arrows onto each organelle in Figure 6.1 to show the direction in which protons are pumped.

[2]

- (b) In addition to facilitating the formation of proton gradients, state one other importance of compartmentalisation within organelles **A** or **B** for ATP synthesis.

.....
 [1]

In 1882, the German botanist T.W. Engelmann performed an experiment to investigate the effects of different wavelengths of light on the rate of photosynthesis using *Spirogyra*. *Spirogyra* is a type of green alga that contains photosynthetic organelles. Other studies have shown that there are pigments that absorb blue, green, yellow and red light in these organelles.

A strand of *Spirogyra* was placed into water containing aerobic bacteria. Different parts of the strand were exposed to different colours of light. After a period of time, the bacteria had moved into the positions shown in Figure 6.2.

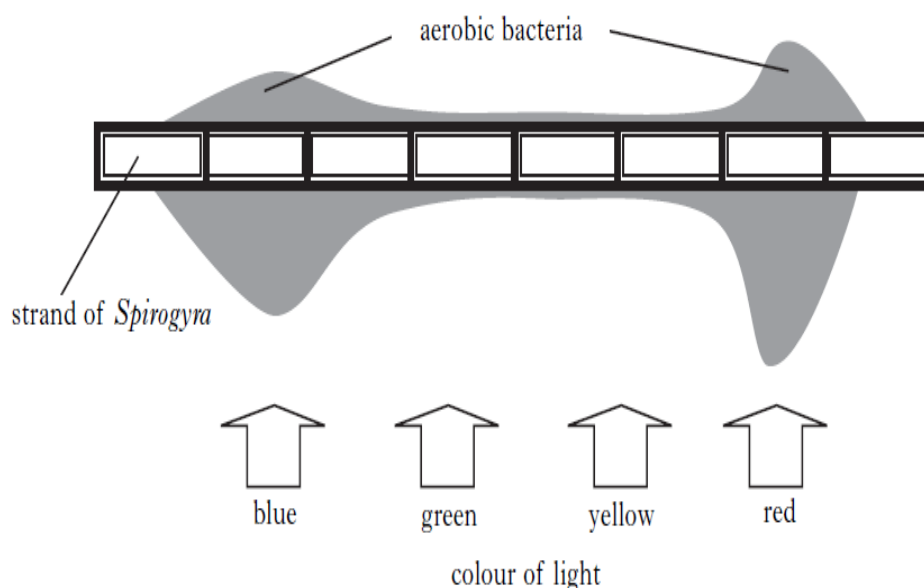

Figure 6.2

It was concluded that wavelengths corresponding to red and blue light caused a higher rate of photosynthesis compared to wavelengths corresponding to green and yellow light.

(c) With reference to Figure 6.2,

(i) explain why the abovementioned conclusion was drawn.

.....

.....

.....

.....

.....

..... [3]

(ii) suggest a role for the pigments absorbing green and yellow light in Spirogyra's photosynthetic organelles.

.....
.....
..... [2]

[Total: 8]

7. Wolf, *Canis lupus*, is one of the world's best known and well researched species, with arguably more books written about it than any other wildlife species. It is the largest extant member of its family, *Canidae*, with males averaging 45kg and females 37kg.

Wolves are further classified into a number of sub-species based on marked phenotypic differences, such as body size and colour. Figure 7.1 shows the several sub-species of wolves in existence today.

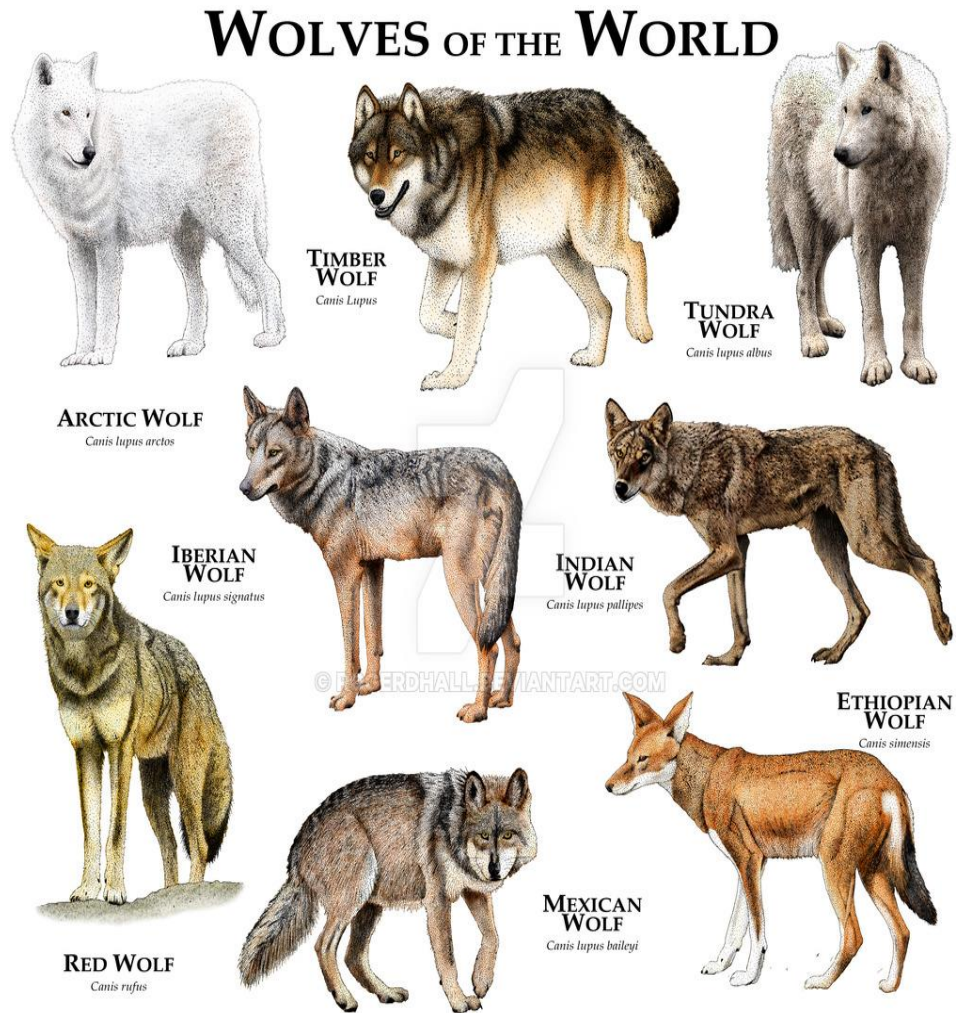

Figure 7.1

- (a) Suggest one reason why the existing populations of wolves are classified as different sub-species rather than different species.

.....
 [1]

Timber wolves are native to the wilderness of Eurasia and North America. Studies have suggested that the timber wolves once co-existed with the extinct dire wolf, *Canis dirus*, on the North American continent.

Figure 7.2 depicts skeletal models of a timber and dire wolf. Dire wolves were larger and had more powerful jaws compared to timber wolves. However, they had proportionally much shorter legs than timber wolves, and were as such slower runners. They are known to feed on different prey, with the large dire wolves favouring larger prey and the timber wolves favouring smaller prey. It is known that the dire wolves went extinct approximately 8000 years ago, which coincides the time period when its large prey declined in numbers.

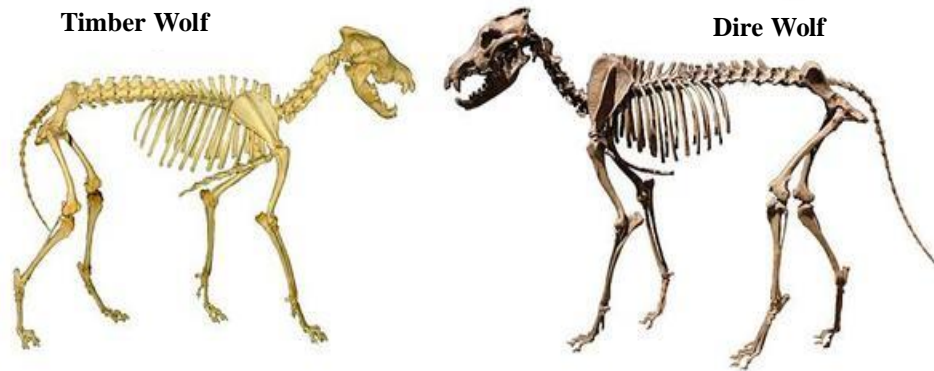

Figure 7.2

(b) Using Darwin’s theory of evolution, explain why the dire wolves went extinct.

.....

.....

.....

.....

..... [3]

(c) Explain why a population is the smallest unit that can evolve.

.....

.....

.....

..... [2]

Scientists used DNA hybridisation to determine the evolutionary relationships between five members of the *Canidae* family. The temperature at which a molecule of double-stranded DNA separates into two single strands is the separation temperature. A region of non-coding DNA was analysed for the study. The scientists recorded the mean separation temperature of this region of DNA in which both strands were from the same species. The scientists then recorded the mean decrease in separation temperature of DNA in which one of the strands was from another species. Their results are shown in Table 7.1

Table 7.1

	Mean decrease in separation temperature/ °C				
	Timber wolf	Dog	Coyote	Ethiopian wolf	Dhole
Timber wolf					
Dog	1.7				
Coyote	2.3	2.3			
Ethiopian wolf	3.6	3.6	3.5		
Dhole	4.8	4.8	4.7	4.9	

- (d) With reference to Table 7.1, explain why Dholes are most distantly related to the timber wolf based on the *Canidae* members studied.

.....

.....

.....

.....

..... [3]

The scientists assume that the decreases in separation temperatures are directly proportional to the time since the evolutionary lines of Canidae members separated. Dogs are thought to have separated from timber wolves 40000 years ago.

- (e) Using this information, calculate how long ago, to the nearest year, Ethiopian wolves and timber wolves separated. Show your working.

[2]

- (f) Distinguish classification from phylogeny.

.....
.....
.....
..... [2]

[Total: 13]

Section B

Answer **one** question.

Write your answers on the separate answer paper provided.

Your answers should be illustrated by large, clearly labelled diagrams, where appropriate.

Your answers must be in continuous prose, where appropriate.

Your answers must be set out in sections **(a)**, **(b)** etc., as indicated in the question.

- 8.**
- (a)** Compare and contrast the reproductive cycles of lambda phage and HIV. [8]
 - (b)** Describe the structural features and regulation of the tryptophan operon. [7]
 - (c)** Explain the role of geographical and behavioural isolating mechanisms in the evolution of new species [5]
- [Total: 20]

- 9.**
- (a)** Compare and contrast triglyceride and starch as a storage molecule. [6]
 - (b)** Explain why cancer is a multi-step disease. [8]
 - (c)** Describe the role of receptor tyrosine kinases in insulin signalling. [6]
- [Total: 20]

End Of Paper

Candidate Name: _____

--	--

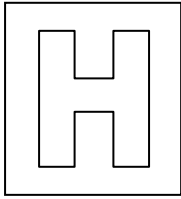

2016 Preliminary Examination II Pre-University 3

H2 Biology**9648/02**

Paper 2 Core Paper

16 September 2016**2 hours**

Additional Materials: Writing paper

READ THESE INSTRUCTIONS FIRST**Do not open this booklet until you are told to do so.**

Write your Admission number and name on all the work you hand in.
Write in dark blue or black pen on both sides of the paper.
You may use a soft pencil for any diagrams, graphs or rough working.
Do not use staples, paper clips, highlighters, glue or correction fluid.

Section AAnswer **all** questions.**Section B**Answer any **one** question.

At the end of the examination, fasten all your work securely together.
The number of marks is given in brackets [] at the end of each question or part question. At the end of the examination, fasten all your work securely together.

For Examiner's Use	
Section A	
1	
2	
3	
4	
5	
6	
7	
Section B	
Total	

This question paper consists of 28 printed pages.

[Turn over

Section A

Answer **all** questions in this section.

1. Figure 1.1 shows a mid-section of a mammalian DNA molecule, comprising Strand A and Strand B, during the S phase of interphase.

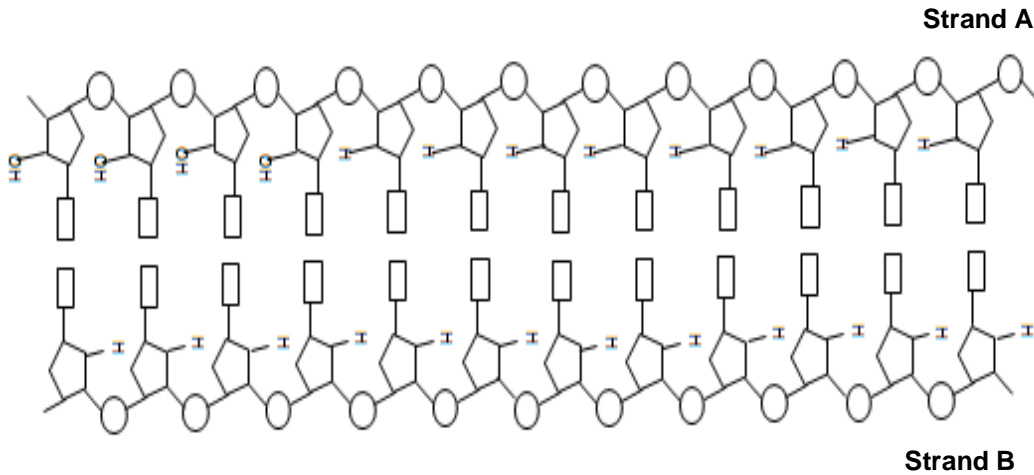

Figure 1.1

- (a) With reference to Figure 1.1,
- (i) account for the difference in the nucleotides in Strand A compared to Strand B.

Strand A has ribonucleotides and deoxyribonucleotides while Strand B has only deoxyribonucleotides;

AND

Strand B is used as the template to guide the synthesis of strand A by semi-conservative replication;

The synthesis of a complementary RNA primer by RNA primase explains the ribonucleotides;

RNA primer is needed as DNA polymerase III can only add deoxyribonucleotides to the free 3' OH end of an already existing polynucleotide;

Max 2

DNA polymerase I removes the RNA primer;

DNA polymerase I replaces RNA primer with complementary deoxyribonucleotides based on the DNA sequence of the intact template strand/Strand B;

Max 1

Figure 1.2 depicts a telomere complex at the end of a chromosome in a human zygote. Telomeres are lengthened during embryonic development to compensate for shortening due to the end-replication problem.

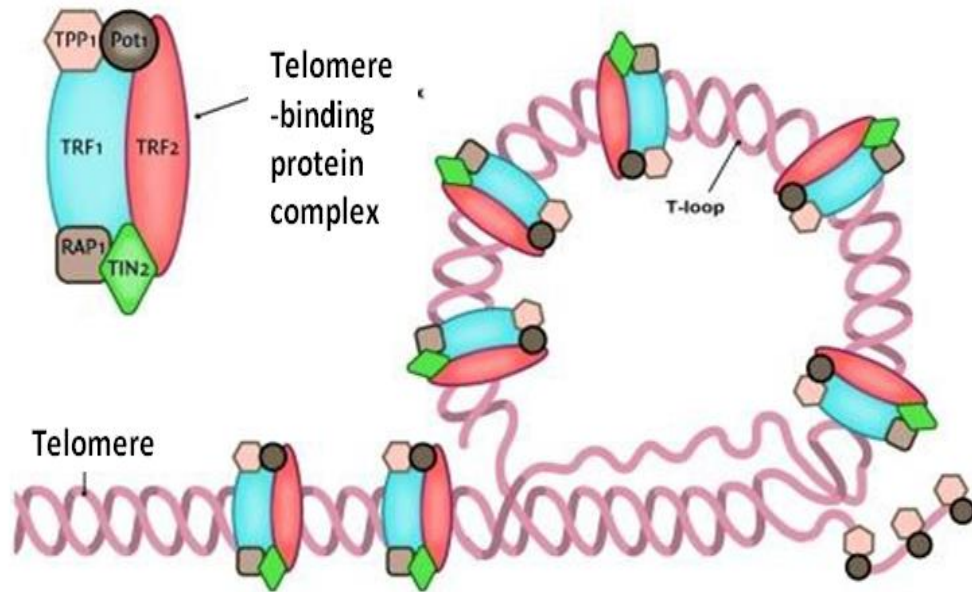

Figure 1.2

(b) Describe two differences between transcription and the process of telomere lengthening.

- .. RNA is used as a template to lengthen the telomere while DNA is used as a template strand in transcription;
 - .. The product synthesised is DNA in the lengthening of the telomere while the product synthesised is RNA in transcription;
 - .. Enzyme involved is telomerase in lengthening of telomere while enzyme involved in transcription is RNA polymerase
 - .. Monomers used in lengthening of the telomere are DNA nucleotides while monomers used in transcription are RNA nucleotides;
- Max 2

A study was conducted to investigate gene expression in yeast. Yeast strain **X** and strain **Y** were used in this study. These strains differed in the location of the *ADE2* gene. In strain **X**, *ADE2* gene is at its normal locus on chromosome 5. An engineered inversion event is responsible for creating strain **Y** where *ADE2* gene locus is near the telomere. Figure 1.3 depicts the loci of the *ADE2* gene in both strain **X** and strain **Y**.

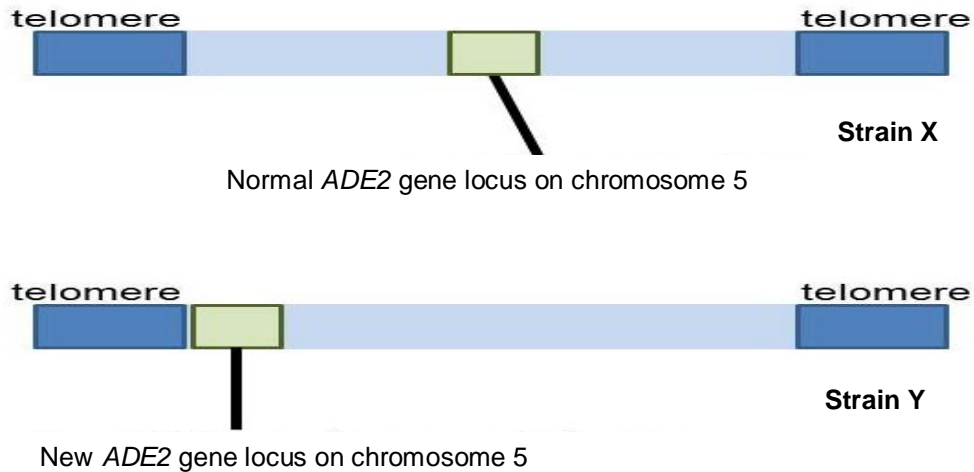
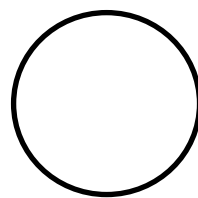
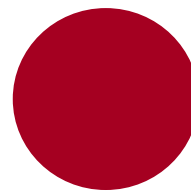

Figure 1.3

The above yeast strains were cultured on specially supplemented agar plates and incubated for one week to produce yeast colonies. Based on the constituents of the Agar, expression of *ADE2* gene prevents accumulation of red pigments and results in cells being white in colour. The colonies produced from this period of incubation are represented in Figure 1.4.



White Colonies
from Strain **X**



Red Colonies from
Strain **Y**

Figure 1.4

Previous studies have shown that some proteins bind to yeast telomeres to recruit histone deacetylase enzymes. These enzymes then act on the chromatin regions around the telomeres.

- (c) Using the above information, explain the difference in colony colour between strain X and strain Y after one week of incubation.

ADE2 gene expression is affected by histone deacetylase recruited by telomere bound proteins in Strain Y while the gene is not affected in strain X due to different positions in the genome;

AND

Histone deacetylase remove acetyl group from the lysine tails of the histone proteins;
The histone proteins regain positive charges;
This increases ionic interactions between histone proteins and DNA;
Result in closer packing of DNA around histone proteins;
Prevents transcription factors/RNA polymerase from accessing promoter of ADE2 gene;
Max 3

The colonies from both strains were allowed incubate for an additional week. Following this, it is then observed that some cells at the edges of the Strain Y colonies appeared white in colour, as depicted in Figure 1.5.

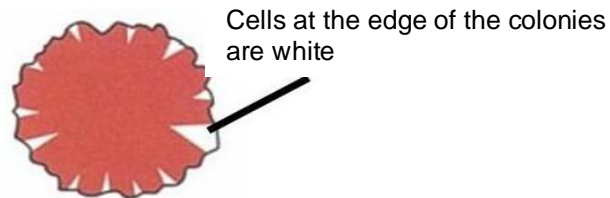

Appearance of colonies from Strain Y after two weeks of incubation

Figure 1.5

- (d) Explain why the cells at the edges of Strain Y colonies appear white in colour after two weeks of incubation.

Telomere length shortens as cells undergo repeated rounds of DNA replication;
Short telomeres in cells at the edge of colony unable to bind to proteins which recruit histone deacetylase;
RNA polymerase and transcription factors are able to bind to ADE2 promoter sequence to form transcription initiation complex;
ADE2 gene is expressed;

[Total: 13]

2. In the cytosol, chaperone proteins can bind reversibly to newly synthesized polypeptides and shield them from other molecules. This prevents the R groups of amino acids from forming bonds with the wrong molecular partners, hence allowing the polypeptides to fold correctly.

Figure 2.1 below shows how chaperone proteins work.

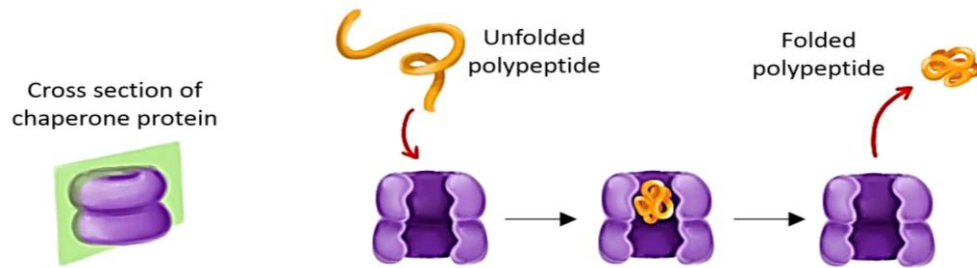

Figure 2.1

- (a) With reference to Figure 2.1, explain how chaperone proteins regulate gene expression.

Chaperone proteins regulate gene expression at the post-translational level;
 Chaperone proteins support production of functional proteins;
 Chaperone proteins provide them with an isolated environment to fold properly;
 Max 2

[2]

- (b) Describe how cytosolic proteins are degraded in cells.

Proteins to be degraded are tagged with ubiquitin molecules;
 Large protein complexes called proteasomes recognise the ubiquitin and degrade the tagged cytosolic proteins;
Proteases and peptidases may also degraded cytosolic proteins;
 Proteins are degraded into smaller peptides or amino acids by hydrolysis of peptide bonds;
 Max 2

[2]

When a protein fails to fold correctly upon synthesis or misfolds at a later stage in its cellular life time, it can no longer fulfil its biological function. Protein misfolding may occur due to mutations in genes or interference with expression of chaperone proteins. Figure 2.2 shows how misfolded proteins may aggregate in a cell.



Figure 2.2

- (c) With reference to Fig. 2.2, suggest why misfolded proteins tend to aggregate in the cell.

Hydrophobic amino acids are exposed in misfolded protein;
Hydrophobic interactions between these amino acids of multiple misfolded proteins cause aggregation;
 Misfolded proteins may not have a shape that is complementary to the active site of proteases for degradation;
 Protein aggregates are too large to enter proteasome to be degraded;
 Max 2;

[2]

An example of a misfolding disease is Bovine spongiform encephalopathy (BSE), a neurodegenerative disease in cattle and commonly referred to as mad cow disease. In BSE, there is an aggregation of misfolded prion protein in the neurons of cattle, which results in degeneration of the brain and spinal cord.

Hereditary forms of BSE have been associated with a mutation in the brain prion protein (PrP) gene, which encodes the PrP protein. The PrP protein is a transmembrane glycoprotein found on the surface of neurons. Figure 2.3 shows the ribbon model of a normal PrP protein.

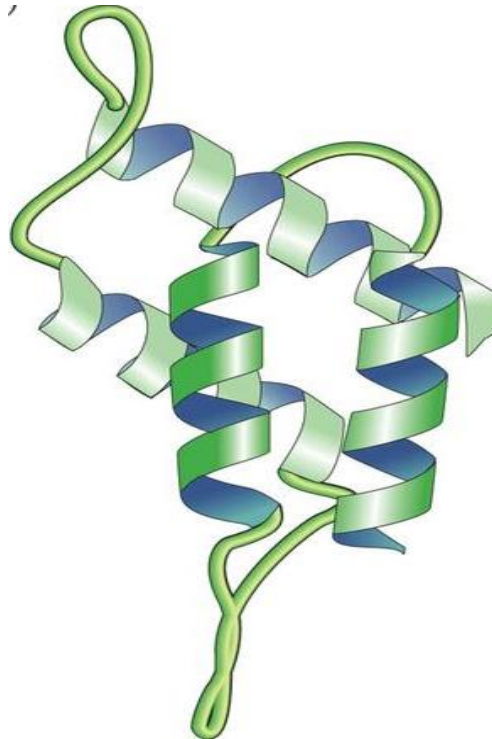

Figure 2.3

- (d) Explain how the PrP protein would maintain its position within the cell membrane.

- ... Polar and charged amino acids of the PrP will interact with the phosphate heads of neighbouring phospholipids by hydrophilic interactions;
- ... Non-polar amino acids of the PrP will interact with the fatty acid tails of neighbouring phospholipids by hydrophobic interactions;
- ... Positon of PrP is also stabilized by cytoskeletal filaments within the cytoplasm;
Max 2

- (e) Describe how the PrP protein on the cell surface membrane is formed after its polypeptide chain has been synthesized.

Following synthesis, the PrP polypeptide is inserted into the lumen of the RER;
 The PrP polypeptide chain folds into its 3D conformation in the lumen and undergoes post-translational modification;
Transport vesicles containing PRP buds off from the RER and travel towards and fuses with the cis face of the Golgi apparatus;
 The PrP protein is further modified to become a functional glycoprotein;
 The protein gets embedded in the GA membrane and is packaged into a Golgi vesicle which buds off from the trans face of the Golgi apparatus;

Max 3

AND

The Golgi vesicle with the embedded PrP moves towards and fuses with the cell surface membrane to insert protein into cell membrane;

4]

A human version of BSE called variant Creutzfeldt-Jakob disease (vCJD) is believed to be caused by eating beef products contaminated with central nervous system tissue from infected cattle. Studies have shown that the introduction of misfolded cattle PrP by consuming contaminated meat can cause normal human prion protein to misfold and form aggregated plaques in the brain.

Health advisories have cautioned that cooking contaminated meat will not provide protection from infection that would lead to vCJD.

- (f) Suggest why cooking contaminated meat products will not provide protection from contracting vCJD.

Heat from cooking is unable to denature misfolded PrP;
 PrP is able to refold into infectious form after heating/cooking;
 Max 1

[1]

3]

3. Burmese cats, *Felis catus*, show discontinuous variation in the colour of their eyes and hearing ability. A large scale investigation was conducted to study the inheritance pattern of eye colour and deafness in such cats.

Pure-breeding blue eyed cats which were deaf were crossed with pure-breeding yellow eyed cats with normal hearing.

The F₁ all had yellow eyes and normal hearing.

Female cats from the F₁ were crossed with male cats with blue eyes and were deaf. 668 offspring were produced.

The observed numbers of F₂ cats with each phenotype were as follows:

Blue eyes, deaf	259
Blue eyes, normal hearing	72
Yellow eyes, deaf	53
Yellow eyes, normal hearing	284

- (a) State what is meant by pure-bred cats for eye colour and hearing ability.

Cats are homozygous for eye colour and hearing ability;
Cats have identical alleles at the loci for eye colour and hearing ability;
Max 1

.....
... [1]

A chi-squared test, with the guide of Table 3.1, was planned to evaluate the difference between observed and expected results.

Table 3.1

Degree of Freedom	Probability, p				
	0.10	0.05	0.02	0.01	0.001
1	2.71	3.84	5.41	6.64	10.83
2	4.61	5.99	7.82	9.21	13.82
3	6.25	7.82	9.84	11.35	16.27
4	7.78	9.49	11.67	13.28	18.47

167 Blue eyes, deafness, 167 Blue eyes, normal hearing, 167 Yellow eyes, deafness, 167 Yellow eyes, and normal hearing;
1 Blue eyes, deafness: 1 Blue eyes, normal hearing: 1 Yellow eyes, deafness: 1 Yellow eyes, normal hearing;
Equal ratio for all 3 phenotypes;
Max 1m

...sing F₁
..... [1]

- (c) With reference to Table 3.1, outline how the significance of the difference between observed and expected results can be evaluated with 98% confidence (Formulae not required).

Carry out chi-squared test with degree of freedom =3 and p=0.02;

If calculated χ^2 is >9.84 difference is significant;

If calculated χ^2 is <9.84 difference is not significant;

If calculated χ^2 is <9.84 difference is due to chance deviation;

Max 2

[2]

The diff
be sign

(d)

Let Y represent the allele coding for yellow eyes.
 Let y represent the allele coding for blue eyes.
 Let H represent the allele coding for hearing ability.
 Let h represent the allele coding for lack of hearing ability.

F1 phenotype: Female cat with yellow eyes and normal hearing X Male cat with blue eyes and deafness

F1 genotype: $\begin{array}{c} Y & H \\ + & + \\ \hline y & h \end{array}$ X $\begin{array}{c} y & h \\ + & + \\ \hline y & h \end{array}$

Gametes: $\begin{array}{c} Y & H \\ + & + \\ \hline \end{array}$ $\begin{array}{c} y & h \\ + & + \\ \hline \end{array}$ $\begin{array}{c} y & h \\ + & + \\ \hline \end{array}$ $\begin{array}{c} Y & h \\ + & + \\ \hline \end{array}$ $\begin{array}{c} y & H \\ + & + \\ \hline \end{array}$

F2 genotypic ratio: $\begin{array}{c} Y & H \\ + & + \\ \hline + & + \\ \hline y & h \end{array}$ $\begin{array}{c} Y & h \\ + & + \\ \hline + & + \\ \hline y & h \end{array}$ $\begin{array}{c} y & H \\ + & + \\ \hline + & + \\ \hline y & h \end{array}$ $\begin{array}{c} y & h \\ + & + \\ \hline + & + \\ \hline y & h \end{array}$

F2 phenotypic ratio: 284 Yellow eyes, normal hearing : 53 Yellow eyes, deafness : 72 Blue eyes, normal hearing : 259 Blue eyes, deafness

Definition of alleles;

Correct matching of F1 phenotypes and genotypes;

Correct gametes (must be circled) + distinguishing parental and recombinant gametes;

Correct linking of F2 genotype to phenotype;

[4]

The coordinated activity of higher order organisms like cats relies upon a continuous input of information from the internal and external environments. Information is in the form of stimuli, which are detected by receptors. One such receptor is called a Pacinian corpuscle, which is found in the skin.

Fig. 3.1 shows the electrical activity recorded by two microelectrodes inserted into:

- the axon within the Pacinian corpuscle at site **P**, and
- the axon of the sensory neurone leaving the corpuscle at site **Q**

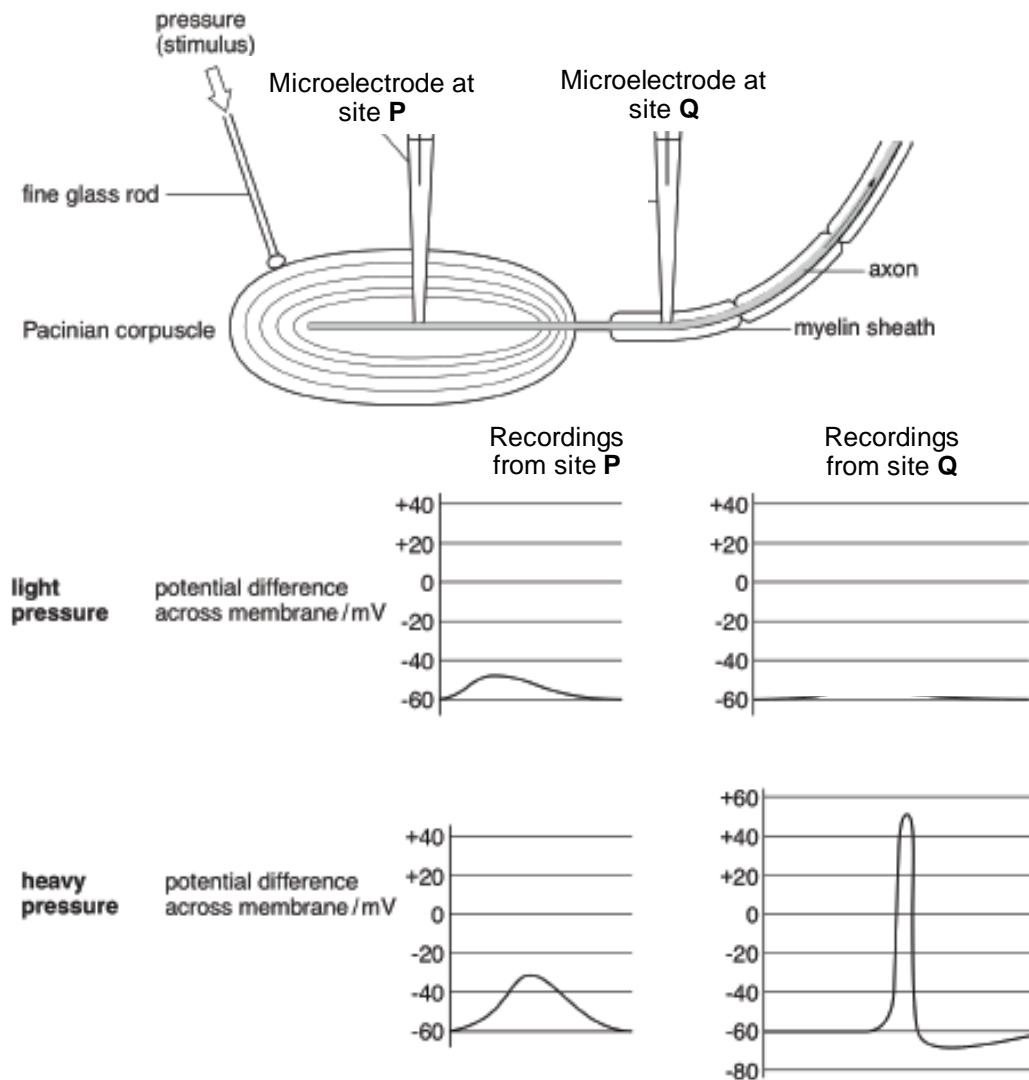

Figure 3.1

- (e) With reference to Figure 3.1, account for the changes in electrical activity in site **P** and **Q** as increasing pressure is applied to the Pacinian corpuscle.

When light pressure is applied, potential difference at **P** increases from -60 to -55mV and there is no change in potential difference at Q;

Depolarization at **P** produces a graded potential that is below threshold potential and therefore no Action potential is generated and transmitted to Q;

When heavy pressure is applied, potential difference at **P** increases from -60 to -30mV and potential difference at **Q** increases from -60 to +40mV;

Depolarization at **P** produces a potential that is above threshold due to the opening of more voltage-gated sodium channels;

This generates an action potential in line with all or none principle;

Depolarisation of adjacent region of axon from influx of sodium ions at **P** during action potential generates action potential at **Q** results in propagation of impulse from **P** to **Q**;

Max 2m

..... [4]

[Total: 12]

4. Rhinoviruses are the most common viral infectious agents in humans and are the predominant cause of the common cold. Symptoms include sore throat, runny nasal congestion, sneezing and cough which may be accompanied by muscle aches and loss of appetite.

The structure of the human rhinovirus is depicted in Figure 4.1. Human rhinoviruses are composed of a capsid that contains four viral proteins **VP1**, **VP2**, **VP3** and **VP4**. Each virion has one copy of single-stranded positive sense RNA genome of between 7200 and 8500 nucleotides in length.

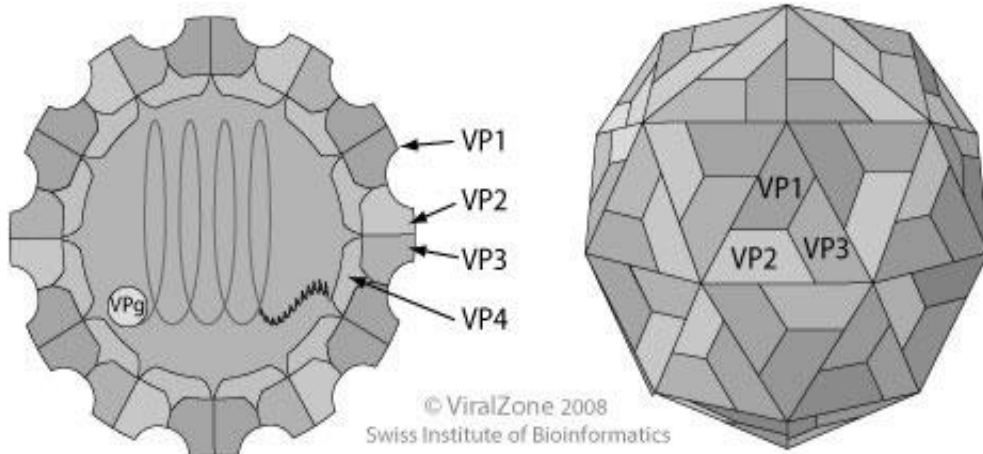

Figure 4.1

Despite structural differences, both human rhinovirus and the influenza virus are able to penetrate respiratory epithelial cells for infection.

- (a) Explain how it is possible for both human rhinovirus and the influenza virus to be able to penetrate human respiratory epithelial cells.

Surface proteins on human rhinovirus and the Influenza virus can bind to different receptors on human respiratory epithelial cells;
Max 1

..... [1]

The enzyme neuraminidase plays an important role after new influenza virions exit their host cells from each round of infection.

- (b) Describe the role of neuraminidase in the reproductive cycle of the influenza

Neuraminidase prevents the clumping of influenza virions to host cell/among themselves after they have budded from cell membrane;
It cleaves the attachment/bond between the HA on influenza and sialic acid residues on the host cell membrane;
Neuraminidase therefore promotes the spread of progeny influenza virions from the host cell surface to infect other host cells;
Max2

- (c) With reference to Figure 4.1, explain why it is unlikely that the newly assembled human rhinovirus exit their host cells in the same way as influenza virions.

Human rhinovirus is a non-enveloped virus;
When influenza viruses bud from host cell, they acquire part of the host cell surface membrane as their viral envelop;
Human rhinovirus is likely to lyse host cell for release;
Max2

[2]

H7N9 is a subtype of Avian Influenza virus, which normally circulates amongst the avian populations with some variants known to occasionally infect humans. An H7N9 virus was first reported to have infected humans in 2013 in China and now this virus has spread among humans. Figure 4.2 shows the proposed evolution of H7N9 virus.

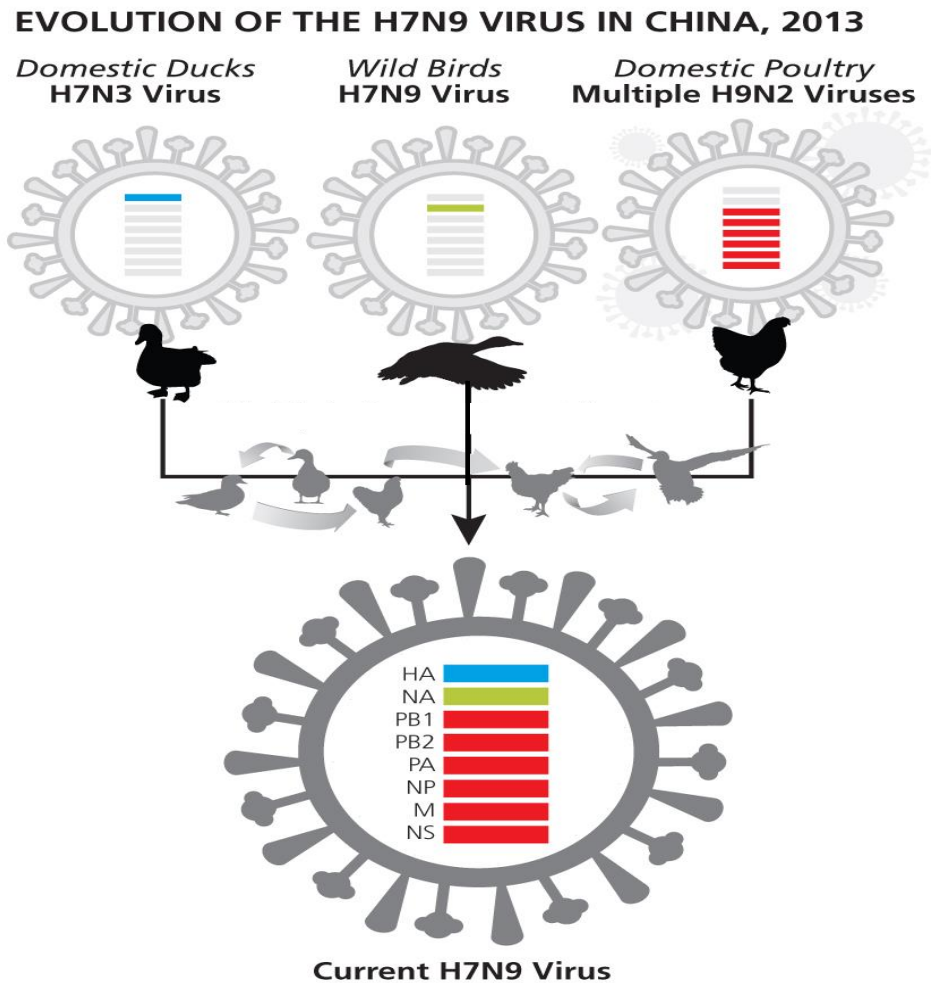

Figure 4.2

(d)

Antigenic shift;
 Where H7N3, H7N9 and H9N2 strains infect a series of intermediate host cells at the same time;
 The cell is replicating the viral genomes of multiple strains at the same time;
 RNA segments are randomly assembled from multiple strains during replication of viral genomes;
Reassortment of genes from these strains occurs resulting in the new combination of RNA segments for H7N9;
 Max 3

A

[3]

Today viruses are considered an exception to the cell theory which states that the basic units of life are cells. Viruses have been referred to as “organisms at the edge of life”.

(e) State one characteristic of viruses that may classify them as being

Adapt to unfavourable environments by exhibiting high mutation rates which increase genetic variation;
Able to reproduce by taking over the genetic machinery of its host cells;
Certain viruses are able to respond to external stimuli by switching reproductive cycle;
Contains nucleic acid (DNA or RNA) as its genome to pass on genetic characteristics from one viral generation to the next;
 Max 1

They are acellular and contain no cytoplasm or cellular organelles;
Viruses do not grow, divide or increase in size;
Viruses do not move on its own and can only be carried by host cells or extracellular medium;
Viruses have no ability of regulating internal environment;
Viruses carry out no metabolism on their own;
Viruses lack enzymes to carry out nucleic acid, protein or ATP synthesis.
 Max 1

.....
 ... [1]
 al: 10]

5. A study was carried out to measure the concentrations of glucose and insulin in the blood of students. The results are summarised in Fig. 5.1.

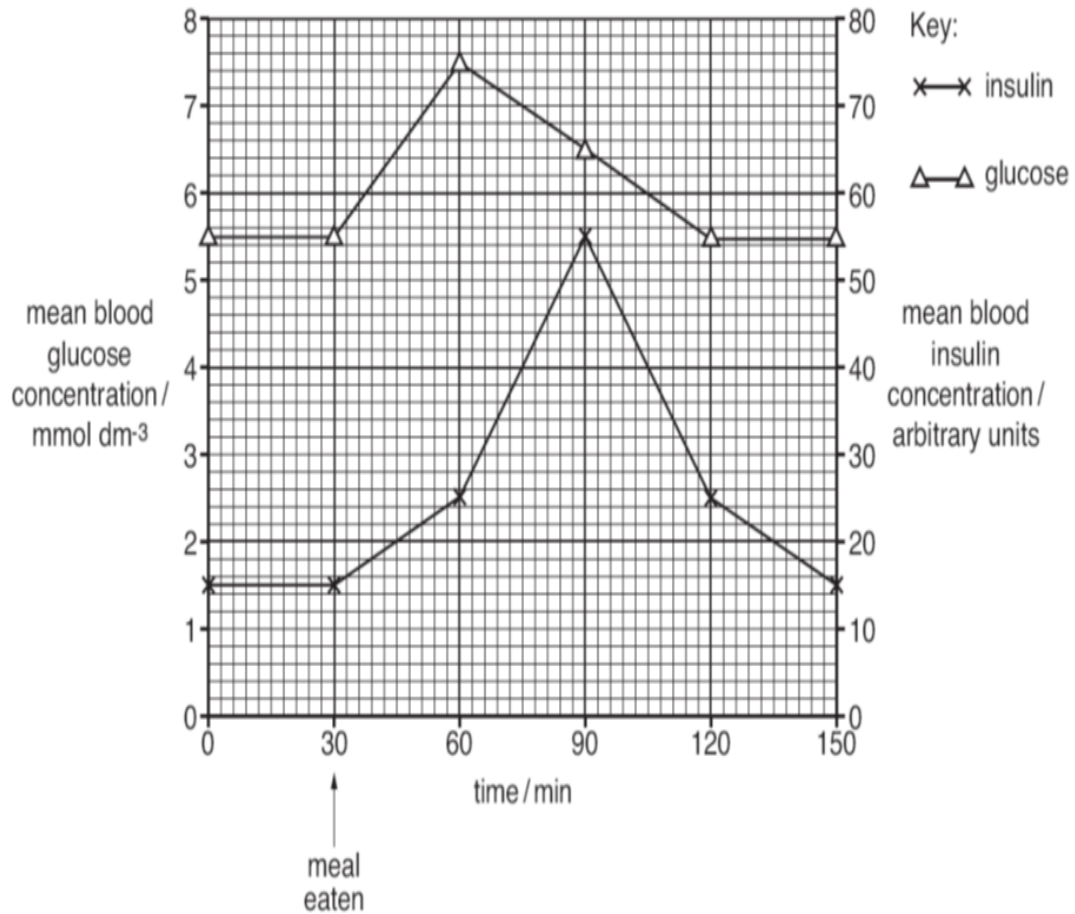

Figure 5.1

- (a) With reference to Figure 5.1, account for the relationship between the concentration of glucose and the concentration of insulin after a meal

Rise in glucose concentration from 5.5 to 7.4 mmol/dm³ between 30 to 60min is detected by β cells islets;
This results in the increase in insulin secretion into the blood from 15 to 55 arbitrary units between 30 to 90min;

AND

Insulin binding to receptors on the liver / muscle/ adipose cells;
Insulin signalling results in

- Increased glucose uptake; and utilization in target cells;
- Increased glycogenesis in liver cells;
- Increased protein synthesis;
- Inhibition of glycogenolysis and gluconeogenesis;

Max 2

This results in glucose concentration being lowered from 7.4 to 5.5mmol/dm³ between 60 to 120min;

Decreased blood glucose levels serves as negative feedback to the β -cells which decreased the secretion of insulin, lowering insulin levels from 55 to 15 arbitrary units from 60 to 150mins;

[5]

Figure 5.2 outlines some steps in glucose metabolism in human muscle cells.

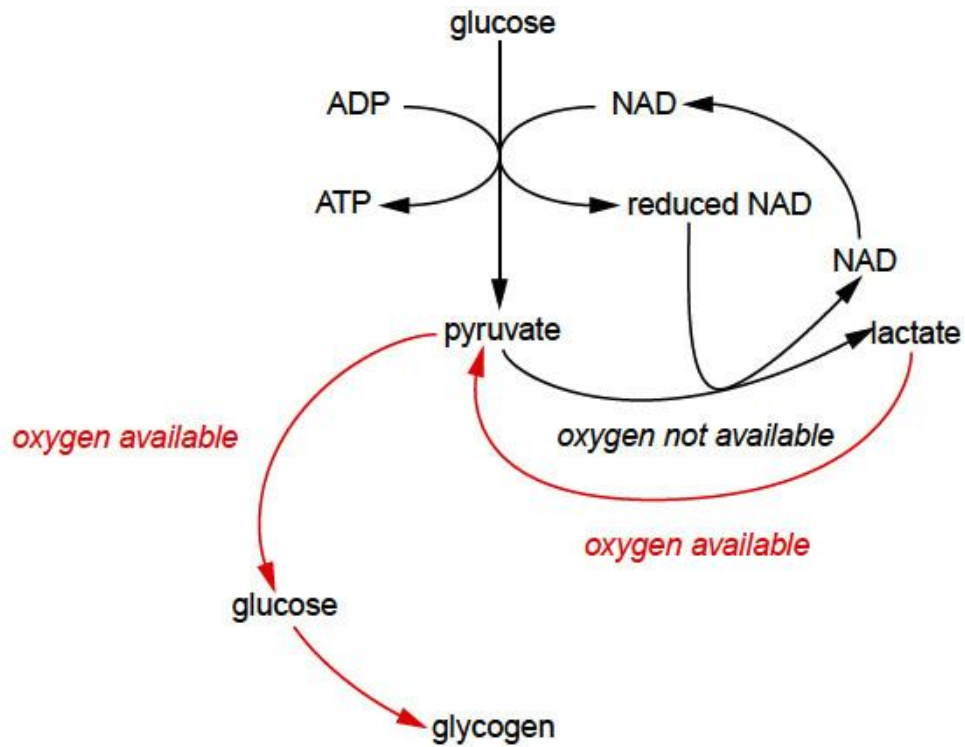

Figure 5.2

- (b) Explain why pyruvate needs to be converted to lactate in the absence of oxygen.

When oxygen is absent, cells will not be able to produce ATP by oxidative phosphorylation;
 Conversion of pyruvate to lactate is needed to regenerate NAD so that glycolysis can continue;
 NAD is needed during glycolysis to produce 2 net ATP via substrate level phosphorylation during glycolysis;
 Max2

Hexokinase is an enzyme that plays a critical role in glucose metabolism. This enzyme converts glucose into glucose-6-phosphate. This step is important as it energises glucose for further metabolic reactions. Fig. 5.3 is a computer-generated image of the enzyme hexokinase binding with its substrate, glucose.

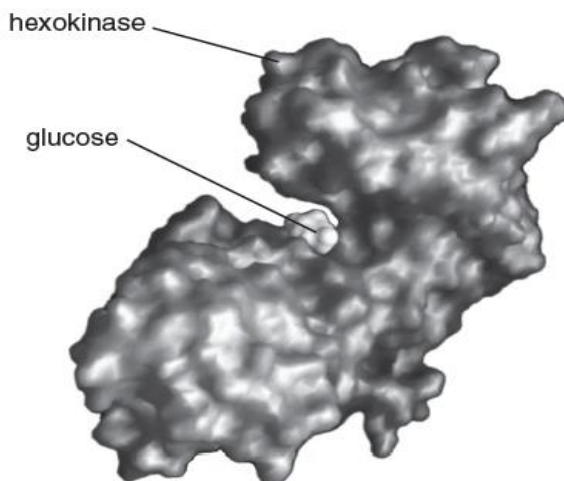

Figure 5.3

Crystallization studies have shown that the shape of hexokinase's active site is not complementary to the shape of glucose.

- (c) Describe the mechanism by which hexokinase binds to glucose.

Induced fit mechanism;
Loose association with substrate causes conformation change in enzyme's active site;
 Conformational change causes enzyme active site to be complementary to the shape of glucose;
 Allows active site to fit to substrate more precisely /allows stronger binding of substrate with enzyme's active site;
 Max 2

[2]

The phosphorylation of glucose by hexokinase also prevents it from leaving the liver cells.

- (d) Suggest why glucose-6-phosphate cannot move out of liver cells.

Glucose-6-phosphate is polar;
Hydration shell of Glucose-6-phosphate prevents it from passing through hydrophobic core of membrane;
 There are no specific transport protein for Glucose-6-phosphate to facilitate transport out of cells;
 Max 2

[2]

[Total: 11]

6. Most ATP is made in cells by membrane systems that create proton gradients by pumping protons from one compartment to another. Figure 6.1 show two such organelles.

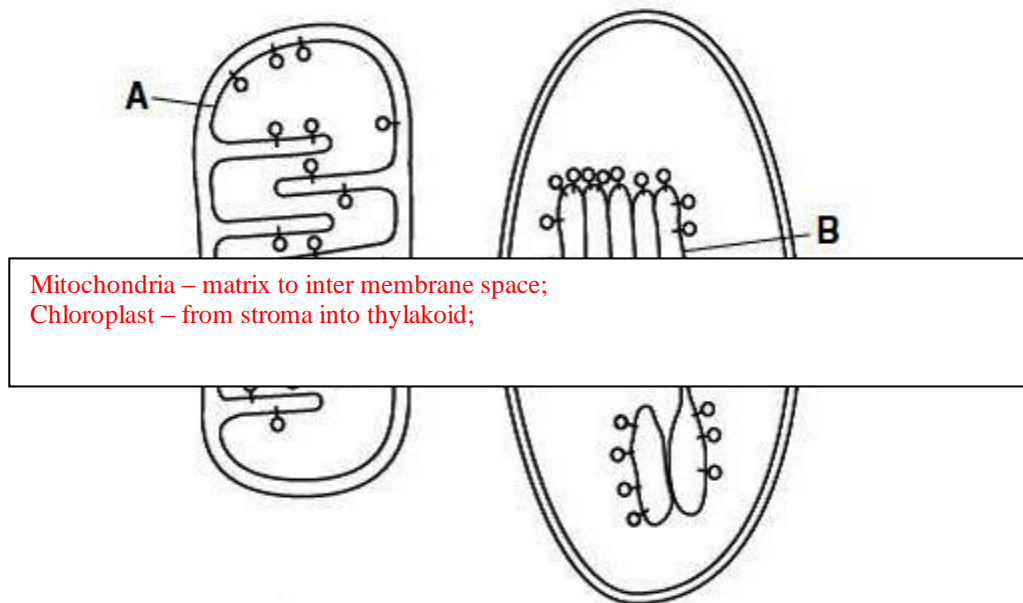

Figure 6.1

- (a) Draw arrows onto each organelle in Figure 6.1 to show the direction in which protons are pumped.

[2]

- (b) In addition to facilitating the formation of proton gradients, state one other importance of compartmentalisation within organelles **A** or **B** for ATP synthesis.

Enzymes and substrates of Krebs cycle are kept in close proximity/ confined within the matrix optimising rate of reactions

OR

Enzymes and substrates of Calvin cycle are kept in close proximity/ confined within the stroma optimising rate of reactions;

Optimal conditions e.g. pH for enzymes of Krebs cycle can be maintained within matrix for higher rate of reaction;

OR

Optimal conditions e.g. pH for enzymes of Calvin cycle can be maintained within stroma for higher rate of reaction;

Prevent intermediates from different metabolic pathways from interfering from each other;

AVP

In 1882, the German botanist T.W. Engelmann performed an experiment to investigate the effects of different wavelengths of light on the rate of photosynthesis using *Spirogyra*. *Spirogyra* is a type of green alga that contains photosynthetic organelles. Other studies have shown that there are pigments that absorb blue, green, yellow and red light in these organelles.

A strand of *Spirogyra* was placed into water containing aerobic bacteria. Different parts of the strand were exposed to different colours of light. After a period of time, the bacteria had moved into the positions shown in Figure 6.2.

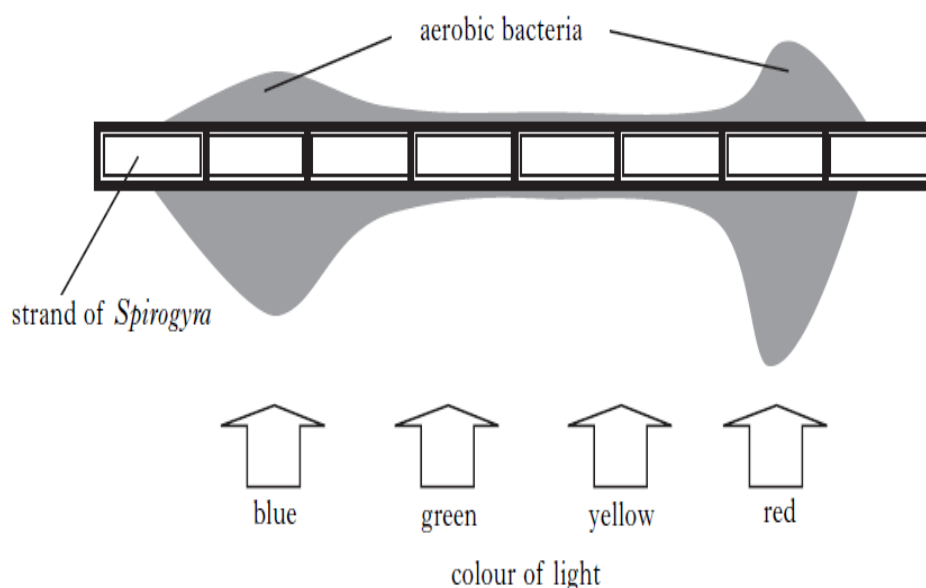

Figure 6.2

It was concluded that wavelengths corresponding to red and blue light caused a higher rate of photosynthesis compared to wavelengths corresponding to green and yellow light.

(c) With reference to Figure 6.2,

(i) explain why the abovementioned conclusion was drawn.

.....

There is a more/greater distribution of aerobic bacteria in the regions with red and blue light compared to regions with yellow and green light;

AND

Aerobic bacteria is attracted towards oxygen produced by the algae;
Oxygen is produced by photolysis of water during non-cyclic photophosphorylation within the light dependent reactions;
A greater amount of oxygen produced with red and blue light attracts more aerobic bacteria;
Max2

- (ii) suggest a role for the pigments absorbing green and yellow light in Spirogyra's photosynthetic organelles.

Broadened/widen the absorption spectrum / widen action spectrum;
They channel light energy of different wavelengths to chlorophyll a/main
photosynthetic pigment/reaction centre;
Increase the efficiency of photosynthesis;
Max 2

[Total: 8]

7. Wolf, *Canis lupus*, is one of the world's best known and well researched species, with arguably more books written about it than any other wildlife species. It is the largest extant member of its family, *Canidae*, with males averaging 45kg and females 37kg.

Wolves are further classified into a number of sub-species based on marked phenotypic differences, such as body size and colour. Figure 7.1 shows the several sub-species of wolves in existence today.

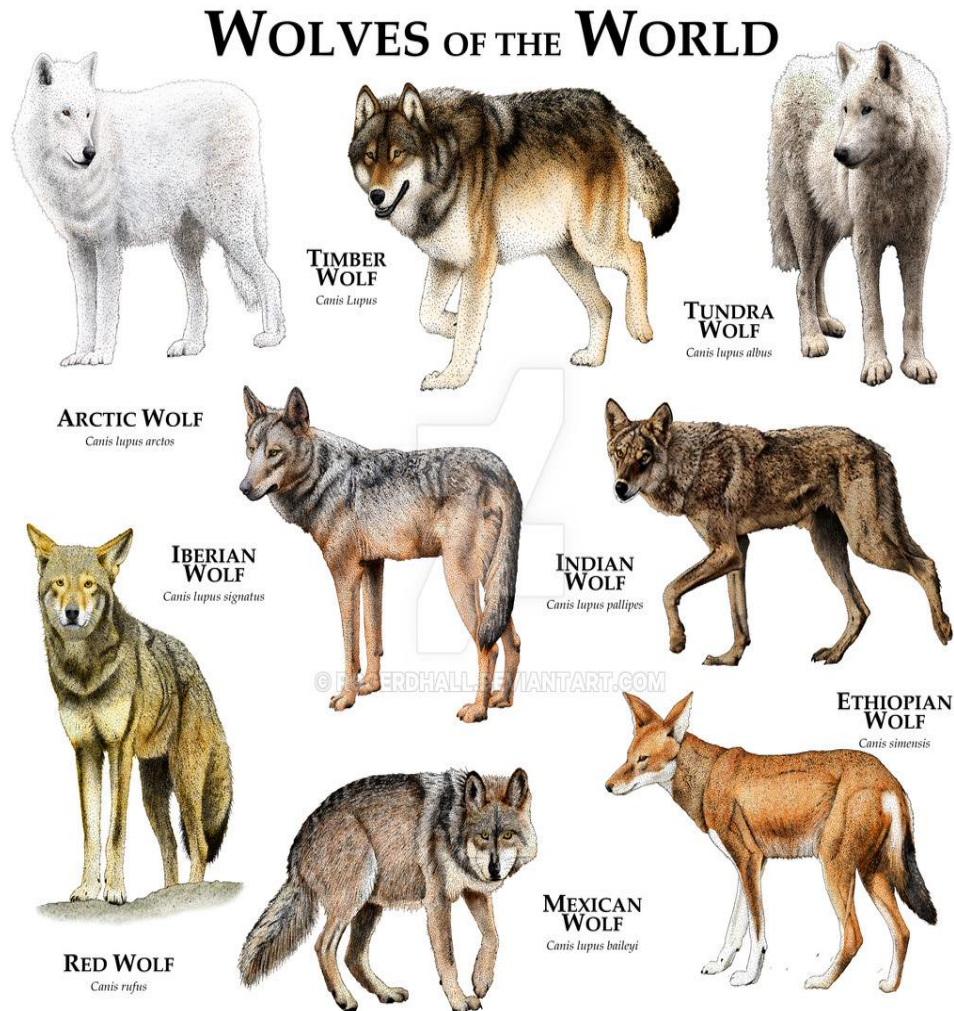

Figure 7.1

- (a) Suggest one reason why the existing populations of wolves are classified as

Can interbreed to produce fertile and viable offspring (although geographically isolated);
 DNA sequence of many genes very similar;
 Morphological/physiological/behavioural/biochemical features (name 2 out of the 4) are very similar but not different enough to be classified as distinct species;
 Occupy same ecological niche;
 Max 1

Timber wolves are native to the wilderness of Eurasia and North America. Studies have suggested that the timber wolves once co-existed with the extinct dire wolf, *Canis dirus*, on the North American continent.

Figure 7.2 depicts skeletal models of a timber and dire wolf. Dire wolves were larger and had more powerful jaws compared to timber wolves. However, they had proportionally much shorter legs than timber wolves, and were as such slower runners. They are known to feed on different prey, with the large dire wolves favouring larger prey and the timber wolves favouring smaller prey. It is known that the dire wolves went extinct approximately 8000 years ago, which coincides the time period when its large prey declined in numbers.



(b)

Usin

Dire wolves faced a lack of large prey / competition from timber wolves as selection pressure;

Dire wolves had a selective disadvantage as:

Larger prey declined in numbers compared to small prey;

Timber wolves are more agile and can outcompete dire wolves for small prey;

Dire wolves were larger and slower in catching small prey;

(Max 2 marks for selective disadvantage)

AVP

Dire wolves had lower fitness compared to timber wolves and reproduced in smaller numbers eventually leading to their extinction;

Max 3

[3]

(c)

Explain why a population is the smallest unit that can evolve

Although natural selection acts on individuals, individuals do not change or evolve over their lifespan;

Variation (within the gene pool) only occurs at the population level;

Evolution is determined by change in allele frequency in a population over several generations of individuals/time.

Individuals must be able to interbreed with other members within the population to pass on alleles for any possible change in allele frequency;

Max 2

[2]

Scientists used DNA hybridisation to determine the evolutionary relationships between five members of the *Canidae* family. The temperature at which a molecule of double-stranded DNA separates into two single strands is the separation temperature. A region of non-coding DNA was analysed for the study. The scientists recorded the mean separation temperature of this region of DNA in which both strands were from the same species. The scientists then recorded the mean decrease in separation temperature of DNA in which one of the strands was from another species. Their results are shown in Table 7.1

Table 7.1

	Mean decrease in separation temperature/ °C				
	Timber wolf	Dog	Coyote	Ethiopian wolf	Dhole
Timber wolf					
Dog	1.7				
Coyote	2.3	2.3			
Ethiopian wolf	3.6	3.6	3.5		
Dhole	4.8	4.8	4.7	4.9	

- (d) With reference to Table 7.1, explain why Dholes are most distantly related to the timber wolf based on the *Canidae* members studied.

The mean decrease in separation temperature is greatest for between dhole and timber wolf at 4.8 °C as compared to other animals with respect to timber wolf;
 This implies that there are fewer hydrogen bonds/ complementary base pairs in tested DNA sequence between timber wolf and dhole;
 Fewer complementary base pairs in DNA sequences between different organisms reflect a greater number of nucleotide differences in the DNA sequence;
 Relatedness decreases with increasing number of nucleotide difference in DNA sequence (OWTTE);

The scientists assume that the decreases in separation temperatures are directly proportional to the time since the evolutionary lines of *Canidae* members separated. Dogs are thought to have separated from timber wolves 40000 years ago.

- (e) Using this information, calculate how long ago, to the nearest year, Ethiopian wolves and timber wolves separated. Show your working.

3.6/1.7 X 40,000;
84706 years;

Feature	Classification	Phylogeny
Basis of grouping	Organisms are <u>grouped based on similarities in characteristics</u> ; and does <u>not consider evolutionary relationships</u> ;	Organisms are <u>grouped into taxons</u> ; that is <u>based on evolutionary relationships</u> ;
Format of organisation	Organisation is in the <u>form of a hierarchy</u> of increasingly specific/exclusive categories;	Organisation is in the form of <u>phylogenetic tree</u> ;
Natural / man-made organisation	Classification is <u>human effort to give order to data</u> via binomial nomenclature and hierarchy to ensure that organisms can be universally identified by their scientific name;	Phylogeny reflects <u>natural relationship among organisms</u> ;

Identification vs studying relationships

:: for 1m

Marks awarded for point to point comparison

Max 2

Section B

Answer **one** question.

Write your answers on the separate answer paper provided.

Your answers should be illustrated by large, clearly labelled diagrams, where appropriate.

Your answers must be in continuous prose, where appropriate.

Your answers must be set out in sections **(a)**, **(b)** etc., as indicated in the question.

- 8.
- (a) Compare and contrast the reproductive cycles of lambda phage and HIV. [8]
 - (b) Describe the structural features and regulation of the tryptophan operon. [7]
 - (c) Explain the role of geographical and behavioural isolating mechanisms in the evolution of new species [5]
- [Total: 20]

- 9.
- (a) Compare and contrast triglyceride and starch as a storage molecule. [6]
 - (b) Explain why cancer is a multi-step disease. [8]
 - (c) Describe the role of receptor tyrosine kinases in insulin signalling. [6]
- [Total: 20]

End of Paper

(a) Compare and contrast the reproductive cycles of lambda phage and HIV. [8]

	Lambda Phage	Human immunodeficiency virus (HIV)
Host	<i>E. coli</i> ;	CD4 ⁺ T cells;
Attachment	Tail fibres bind to the surface receptor of cell	HIV GP120 on viral envelope binds to CD4 receptors on T4-lymphocytes
Penetration	Viral tail sheath contracts to injects viral DNA into the host cell.	HIV envelope fuses with host cell surface membrane to enter viral nucleocapsid containing viral genome into host cell.
Synthesis	Does not need reverse transcriptase to produce viral DNA	Uses reverse transcriptase to produce viral DNA
	When viral DNA incorporated into host chromosome, it can also leave to enter lytic cycle	Integrated viral DNA remains a permanent resident of the host cell's genome.
Release	Released by cell lysis of host cell during lytic cycle	Released by budding off from host cell
	Host cells are killed after release of virions.	Host cell still intact after reproduction. Will not die immediately.

Max 4

Both involve binding to specific receptor sites on host cell for attachment.

Both viral genomes are capable of integration into host cell's genome.

Both viruses are able to propagate without killing the host cells which they are dependent on.

Both viruses require host cell machinery for replication and synthesis of new viral particles;

Max 3

(b) Describe the structural features and regulation of the tryptophan operon. [7]

The tryptophan operon has a promoter which is the RNA polymerase binding site;
Operator which is the binding site for repressor protein;
5 structural genes which are clustered together and controlled by one promoter;
The structural genes are trpE, trpD, trpC, trpB, trpA;
These genes code for enzymes that catalyse the metabolic pathway for tryptophan synthesis;
The operator is sandwiched between the promoter and the structural genes;
Max 4

Trp operon is controlled by negative regulation
Negative regulation of lac operon involves the use of the trp repressor coded by regulatory gene trpR;
In absence of tryptophan the trp repressor is inactive and unable to bind to the operator resulting in transcription of the structural genes for tryptophan synthesis;
When tryptophan is present in high amounts, it acts as a co-repressor and binds to the trp repressor to activate it;
Activated trp repressor binds to the operator and blocks access of RNA polymerase to promoter to inhibit transcription of the trp operon;
Max 4

(c) Explain the role of geographical and behavioural isolating mechanisms in the evolution of new species [5]

Speciation occurs when there is disruption to gene flow in a population of a particular species;
Disruption of gene flow can occur by behavioural isolation;
Geographical isolation occurs when there is a physical barrier separates members of a population into 2 sub populations, preventing interbreeding;
Behavioural isolation, occurs when there is variation in behaviour in a population and members tend to mate preferentially with members with similar behaviour;
Changes in allele frequency occur independently in isolated subpopulation resulting in genetic divergence;

Genetic divergence between isolated sub-populations results in genetically distinct species which are unable to interbreed and produce fertile viable offspring;
Geographical isolation results in allopatric speciation;
Behavioural isolation results in sympatric speciation;

[Total: 20]

(a) Compare and contrast triglyceride and starch as a storage molecule. [6]

Feature	Triglyceride	Starch
Basic units	Triglyceride is made up of 1 glycerol and 3 fatty acid chains;	Starch is made up of repeating units of α glucose;
Type of Bonds	bonds linking up the monomers are ester linkages;	bonds linking up the monomers are glycosidic linkages;
Type of biomolecule	Triglyceride is not a polymer;	Starch is a polymer of glucose;
As energy store	Higher/ twice amount of energy stored/ superior long term energy store per unit mass Due to greater number of carbon atoms/ more C-H bonds for the same mass; lesser amount of fats needs to be stored for the same amount of energy;	Lower/ 2X less energy stored per unit mass; Due to more -OH groups and so less carbon atoms/ less C-H bonds for the same mass; More starch molecules need to be stored for the same amount of energy;

Max 3

Both have high percentage of hydrocarbons and hence stores energy;
Both are macromolecules formed through condensation reactions;
Both are compact;
Both are insoluble and therefore do not affect water potential of cells;

Max 3

(b) Explain why cancer is a multi-step disease.

[8]

The development of cancer requires the accumulation of mutations;

Mutations occur in multiple genes which control regulatory checkpoints of the cell cycle;

Such mutations disrupt the normal cell cycle, thus causing the cell to undergo excessive cell growth and proliferation/division;

A gain-in-function mutation must occur in at least one proto-oncogene;

A gain-of function is a dominant mutation where mutation in just one allele of a proto-oncogene will result in oncogenic conversion;

Oncogenes promote uncontrolled cell growth and proliferation/division;

A loss-of-function must occur in at least one tumour suppressor gene;

As loss-of- function mutations is a recessive mutation, such changes must occur in both copies of the tumour suppressor gene /alleles to disrupt the function of tumour suppressor gene;

Disruption of tumour suppressor genes results in loss of ability to inhibit cell cycle progression/activate DNA repair/ activate apoptosis;

Activation/up-regulation of telomerase gene should also occur for cancer cells to divide indefinitely;

Loss of contact inhibition will enable the cells to grow into a tumour/mass of cells;

Angiogenesis must occur within the tumour so that the blood vessels formed can transport oxygen and nutrients for its growth;

Finally the cells must be able to undergo metastasis/ leave the primary site and spread to other tissues in different parts of the body via the blood stream and form multiple tumours;

(c) Describe the role of receptor tyrosine kinases in insulin signalling. [6]

Insulin as a polar peptide hormone that cannot diffuse/pass through the phospholipid bilayer of the cell membrane;

RTK spans the cell membrane/ is a transmembrane protein;

Each RTK has an extracellular insulin binding domain that is specific / has a complementary shape to that of insulin;

Upon binding of insulin to the extracellular domain, receptor polypeptides dimerise;

Each RTK contains an intracellular /cytoplasmic tyrosine kinase domain;

The tyrosine kinase domain of each polypeptide is activated upon dimerization;

Tyrosine kinase domain transfers / adds a phosphate from an ATP molecule to a tyrosine residue on the intracellular domain of the other polypeptide;

Addition of phosphate groups enables relay proteins binding to specific tyrosine residues on RTKs;

Upon binding, relay proteins undergo conformational changes that results in activation and subsequent signal transduction;

[Total: 20]

Candidate Name: _____

--	--

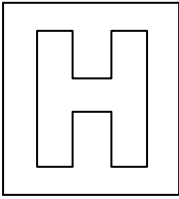

2016 Preliminary Examination II

Pre-University 3

H2 Biology**9648/03****Applications Paper and Planning Question****22 September 2016****2 hours**

Additional Materials: Writing paper

READ THESE INSTRUCTIONS FIRST**Do not open this booklet until you are told to do so.**

Write your Admission number and name on all the work you hand in.
 Write in dark blue or black pen on both sides of the paper.
 You may use a HB pencil for any diagrams or graphs.
 Do not use staples, paper clips, highlighters, glue or correction fluid.

Answer **all** questions.

The use of an approved scientific calculator is expected, where appropriate.
 You will lose marks if you do not show your working or if you do not use appropriate units.
 At the end of the examination, fasten all your work securely together.
 The number of marks is given in brackets [] at the end of each question or part question.

For Examiner's Use	
1	
2	
3	
4	
5	
Total	

This question paper consists of 21 printed pages including 1 blank page

[Turn over

Answer **all** questions.

1. Before the emergence of more advanced technologies, cDNA libraries have been used to study the genetic changes involved in cancer development.

Normal and tumour cells are obtained from the same patient. Reverse transcription is carried out on mRNA isolated from the tumour cells. Primers consisting of thymine repeats were used during reverse transcription to form single-stranded cDNA as depicted in Figure 1.1. These cDNA are then labelled with fluorescent dyes.

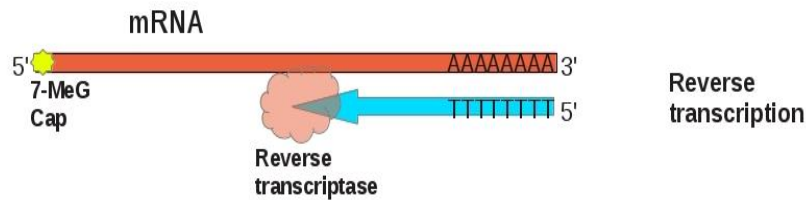

Figure 1.1

Normal cell mRNA and tumour cell cDNA are allowed to hybridise; the resulting double-stranded hybrid molecules and remaining single-stranded mRNA are discarded. Subtracted cDNA (also known as non-hybridized cDNA) are used to form a subtracted cDNA library. The process is summarized by Figure 1.2.

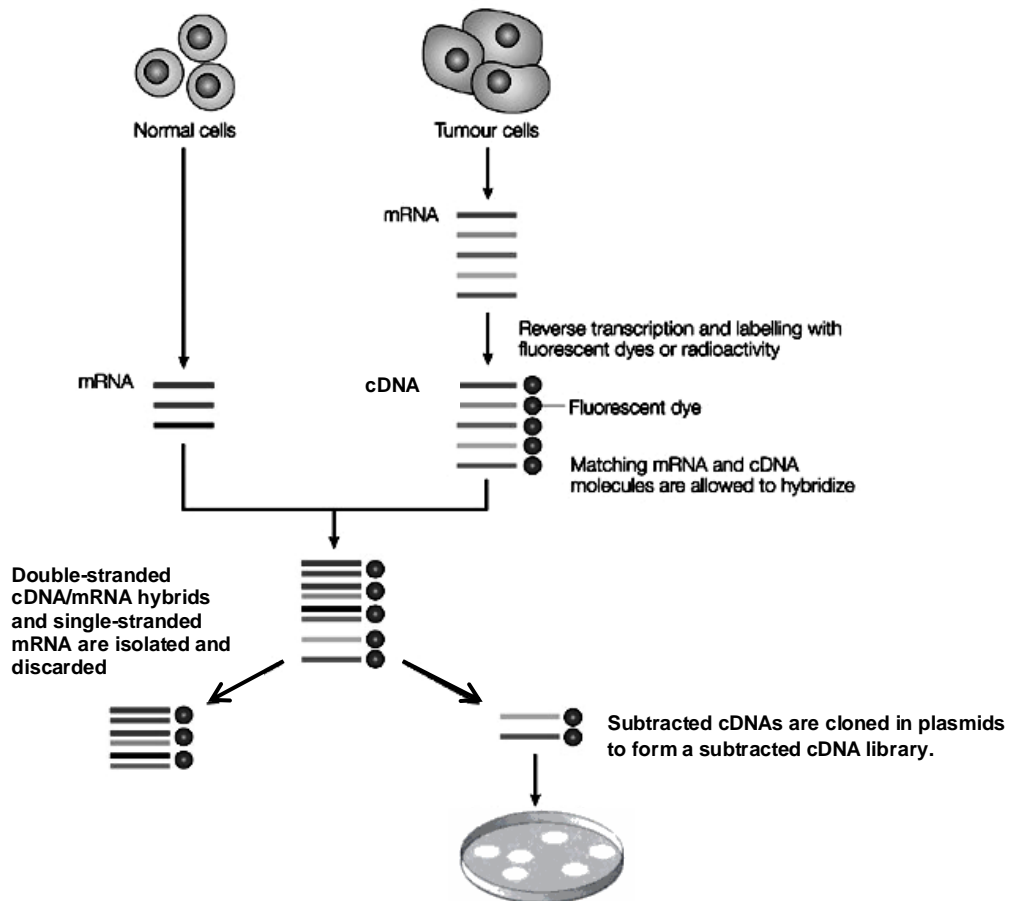

Figure 1.2

A young scientist conducting this procedure was concerned that possible presence of bacteria within cell samples might result in production of bacteria cDNA. This would contaminate downstream processes. However, her concerns were dismissed by her partners who assured her that reverse transcription of bacterial mRNA is unlikely to occur.

- (a) Using the information given, explain why reverse transcription of bacterial mRNA is unlikely to occur.

.....
.....
..... [2]

- (b) Describe the steps needed to create recombinant DNA molecules that are used to assemble a plasmid library of subtracted cDNA.

.....
.....
.....
.....
..... [4]

- (c) Explain why the DNA sequences in the subtracted cDNA library are considered mutant alleles implicated in cancer.

.....
.....
..... [2]

- (d) Suggest why the subtracted cDNA library may not fully capture all possible DNA sequences implicated in cancer.

.....
.....
..... [1]

Screening of the subtracted cDNA library of a cancer patient revealed a mutated protein kinase gene. A research team decided to clone this gene to isolate the mutant protein and study it to better understand its role in cancer development.

The protein kinase gene was first isolated. The artificial plasmid, pKY350, was constructed to act as an expression vector.

The plasmid was constructed to include two genes, each giving resistance to a different antibiotic: an ampicillin resistance gene and a tetracycline resistance gene. The plasmid also has a target site for the restriction enzyme, *Bam*HI, in the middle of the tetracycline resistance gene.

A pKY350 plasmid was cut using *Bam*HI and the cDNA sequence for the mutant protein kinase was inserted into it. Figure 1.3 shows pKY350 and the recombinant plasmid.

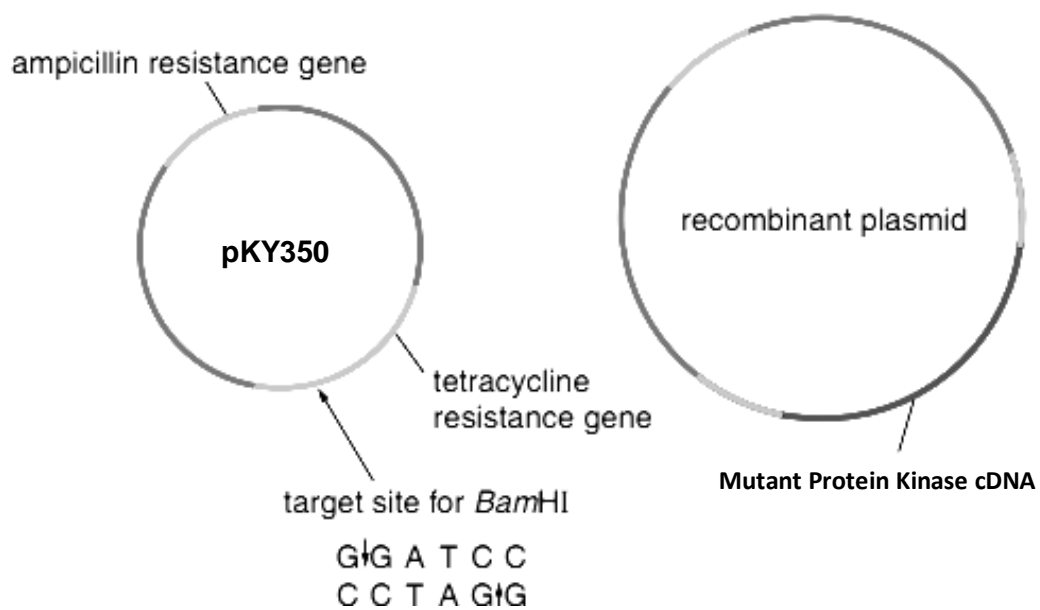

Figure 1.3

The mixture containing recombinant DNA was used to transform *E.coli* bacteria. Replica plating was used to identify recombinant bacteria with the mutant protein kinase gene. Figure 1.4 shows the bacterial colonies that grew on different nutrient agar plates.

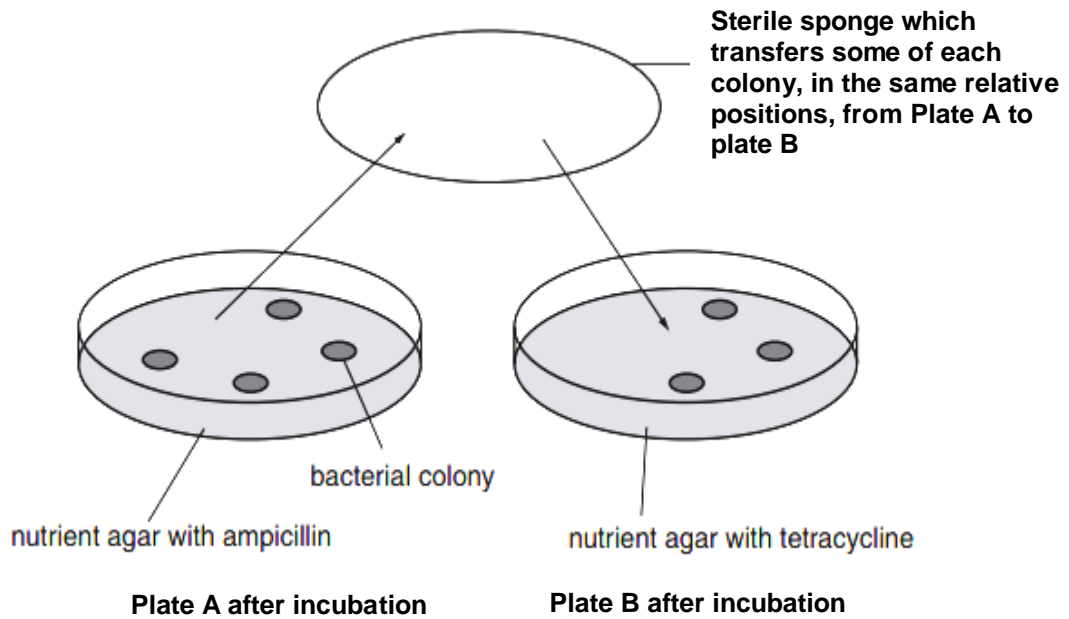

Figure 1.4

- (e) Use a label line and the letter C to identify, on Figure 1.4, a colony of bacteria that contain the recombinant plasmid.

[1]

A senior scientist declared that it would be a challenge to develop a good understanding of the role of the mutant protein kinase in cancer development from studying the recombinant protein produced by a bacterial cloning system.

- (f) Explain why recombinant mutant protein kinase produced by a bacterial cloning system may not be a good model of study for understanding cancer development.

.....

.....

.....

..... [2]

Today, due to the findings of the human genome project, polymerase chain reaction (PCR) has largely replaced cDNA libraries to directly isolate genes in the study of diseases. PCR is normally carried out using the enzyme Taq DNA polymerase. This enzyme was originally extracted from the bacterium *Thermus aquaticus*. This bacterium was found in Mushroom Spring, one of the hot springs in Yellowstone National Park in the USA.

Taq DNA polymerase is now obtained from genetically modified *Escherichia coli* that carry the Taq DNA polymerase gene. The optimum temperature of this enzyme is 75-80°C.

After 40 minutes at 95°C, the activity of the enzyme is reduced by half. This means that the half-life of this enzyme at 95°C is 40 minutes.

- (g) Using your knowledge of PCR, explain why a half-life of 40 minutes at 95°C allows many cycles of PCR before the enzyme needs to be replaced.

.....
.....
.....
.....
..... [3]

- (h) Suggest why Taq DNA polymerase is now obtained from genetically modified *E.coli*.

.....
.....
..... [2]

Work on the human genome project was able to provide many benefits to the field of molecular medicine.

- (i) State 2 other areas that have benefited from work on the human genome project.

.....
..... [2]

[Total: 19]

- 2. Pluripotent stem cells are one type of stem cells and there is widespread interest in their study today. One key reason is because pluripotent stem cells can be induced to differentiate into the specific cell type required to repair damaged or destroyed cells or tissues. Additionally pluripotent stem cells can be used to study early events in human development and find out more about how cells differentiate and function. This may help researchers find out why some cells become cancerous and how some genetic diseases develop.

In 2006, a Japanese Scientist, Shinya Yamanaka, made a ground-breaking finding that would win him the Nobel Prize in Physiology or Medicine just six years later. He discovered that specialized cells can be stimulated to dedifferentiate and change back into pluripotent stem cells in tissue culture. Such cells are called induced pluripotent stem cells (iPS cells).

In experiments with mice, Yamanaka showed that the introduction of four genes caused specialized cells to change to iPS cells. Further studies have shown that these four genes indirectly result in the reprogramming of specialized cells by influencing the activity of many other genes.

- (a) Outline how the addition of the four genes may influence the activity of many other genes to result in the reprogramming of specialized cells into iPS cells.

.....

.....

.....

..... [2]

Pluripotent stem cells can also be derived from cytoplasmic hybrid (cybrid) cells through the method of somatic cell nuclear transfer (SCNT). A procedure for producing pluripotent stem cells by SCNT is outlined in Figure 2.1.

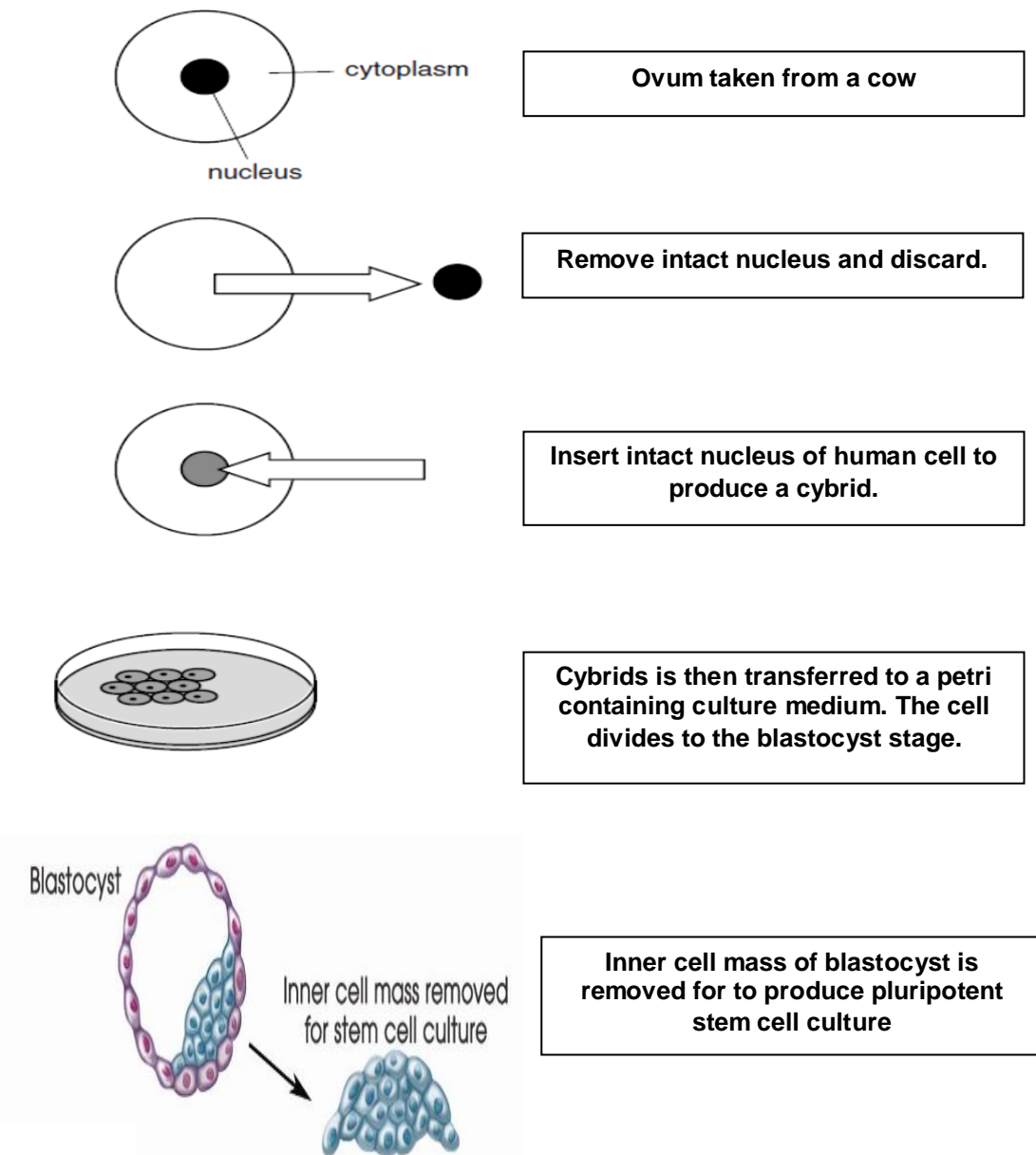

Figure 2.1

The DNA from the pluripotent stem cells generated by the above method is found to be 99.6% human.

(b) Explain the origins of the 0.04% cow DNA that is found in these cells.

.....

.....

..... [2]

Some people have argued that it is unethical to allow the production of cybrids.

(c) Suggest why the production of hybrids may be considered unethical.

.....
..... [1]

In 2008, a woman had her damaged left bronchus replaced by one constructed using her own stem cells. Adult stem cells derived from the woman's own bone marrow were used. Samples of these stem cells, together with cells derived from the lining of her trachea, were placed in a bioreactor for four days during which time they multiplied to coat a collagen framework. This cell coated framework was then used to replace the damaged section of her bronchus. A month later the transplanted tissue had developed its own blood supply. This was claimed to be the first successful transplant using tissues derived from the patient's own stem cells.

(d) State two reasons why using the patient's own stem cells to treat a damaged bronchus is preferred to a transplant involving another donor.

.....
.....
.....
..... [2]

(e) Describe the unique features of the adult stem cells derived from the bone marrow.

.....
.....
.....
.....
..... [3]

[Total: 10]

3. Iron-deficient anaemia is one of the most serious problems worldwide. Some scientists decided to explore the use of transgenic rice with increased copies of the Nicotianamine Synthase (NAS) gene to address the problem of iron deficiency. NAS is an enzyme in the metabolic pathway involved with iron acquisition in the rice plant. In these regards, the use of transgenic rice to address human iron deficiency is based on developing rice with increased iron content as transgenic rice would contain more copies of the NAS gene and produce more NAS enzymes compared to wild type rice.

To produce transgenic rice, a recombinant Ti plasmid containing NAS gene is engineered and reintroduced back into the bacteria *Agrobacterium tumefaciens*. The recombinant bacteria is then allowed to infect the plant. The process showing how transgenic rice plant is produced is illustrated in Figure 3.1.

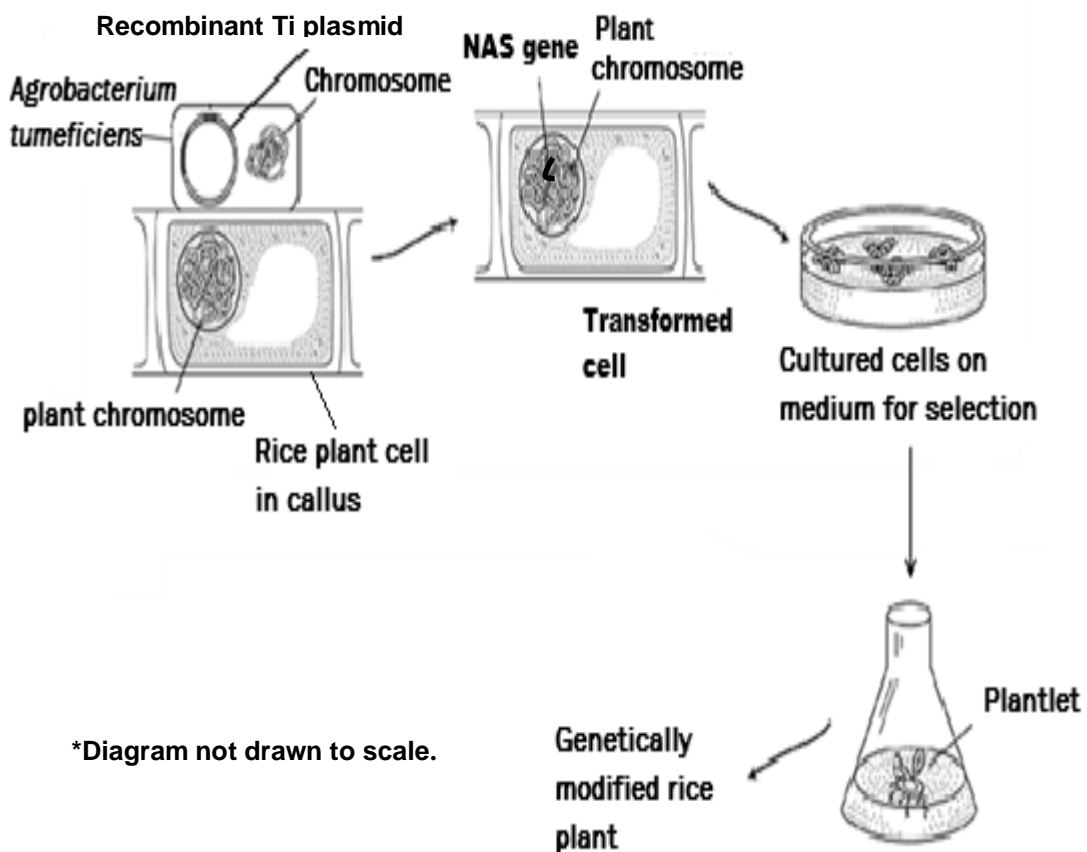

Figure 3.1

The naturally occurring Ti plasmid derived from *Agrobacterium tumefaciens*, is commonly used as a vector for introducing new foreign genes into plant cells. This plasmid integrates a segment of its DNA known as T-DNA, into the chromosomal DNA of host plant cells after infection. Figure 3.2 shows the structure of a natural Ti plasmid.

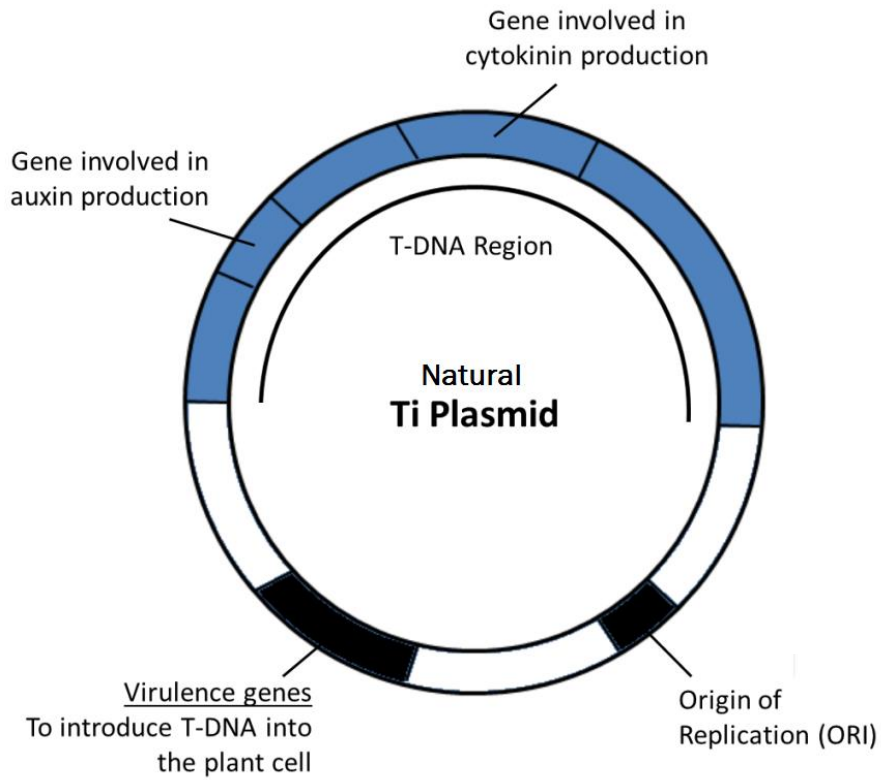

Figure 3.2

The genes for auxin and cytokinin are removed from the T-DNA region from the Ti plasmid before it can be used in the production of transgenic rice.

- (a) Explain why the genes for auxin and cytokinin are removed from the T-DNA region of the Ti Plasmid.

.....

.....

.....

..... [2]

Transgenic rice plants have to undergo a process of acclimatization before they can be transferred to a natural environment for growth.

(b)

(i) Explain the importance of acclimatization.

.....
..... [1]

(ii) Describe a key step in this process.

.....
..... [1]

BLANK PAGE

A study was carried out to evaluate the efficacy of such transgenic rice with increased iron content. Twenty iron-deficient 12-year old girls were selected for the study. The haemoglobin count for each girl chosen was similarly below 12.8gdl^{-3} . The normal haemoglobin count for girls at the age of 12 is 12.8 to 16.0gdl^{-3} .

The girls selected for the study were randomly and equally sorted into a treatment group and a control group. The girls in the treatment group were requested to adhere to a diet of transgenic rice with increased iron content, three times a day, for 5 months. The girls in the control group were requested to adhere to a diet of normal rice grown in the same rice field, three times a day, for 5 months. The mean haemoglobin count for each group was tracked over this period.

The results of the analysis are shown in Figure 3.3.

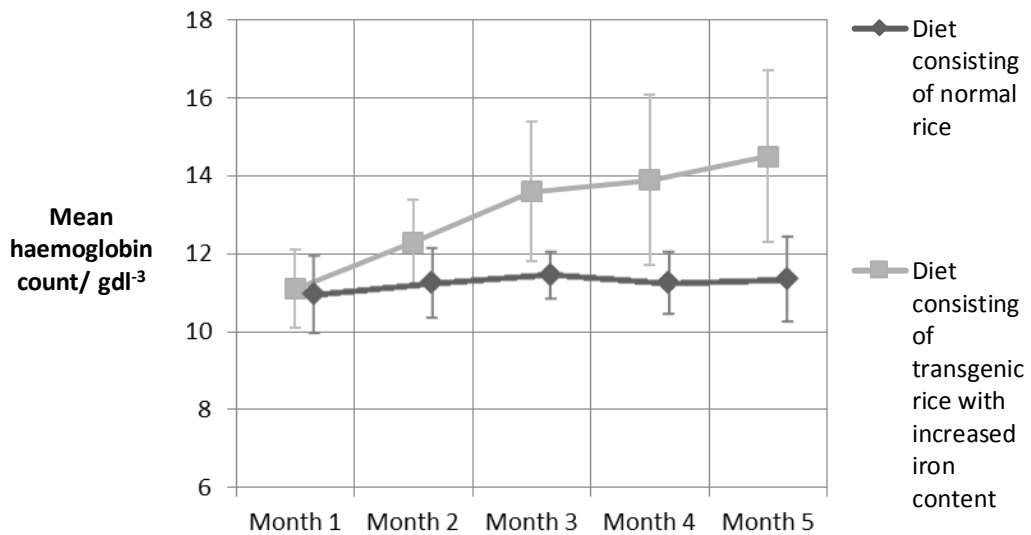

Figure 3.3

At the end of the study, the scientists involved concluded that the transgenic rice was more effective than normal rice in helping iron-deficient children.

(c) With reference to Figure 3.3, discuss the validity of this conclusion.

.....

.....

.....

.....

.....

.....

..... [3]

In addition to producing more nutritious food, genetically engineered crops like Bt corn can also be used in solving the world demand for food.

(d) Explain how Bt corn helps solve the global food challenge.

.....

.....

.....

.....

.....

.....

.....

..... [4]

[Total: 11]

4. Beetroot is a starchy edible root from the *Beta vulgaris* plant whose cells contain a water-soluble red pigment, betacyanin, in their vacuoles. Beet root pigment is used commercially as a food dye and different methods have been used to extract the pigment from intact beetroot cells. This pigment cannot pass through membranes unless the membranes are damaged.

A colorimeter can be used to measure the absorbance of light at 550 nm by betacyanin solution. The concentration of betacyanin is proportional to its absorbance. The use of a colorimeter to measure absorbance by betacyanin is depicted in Figure 4.1.

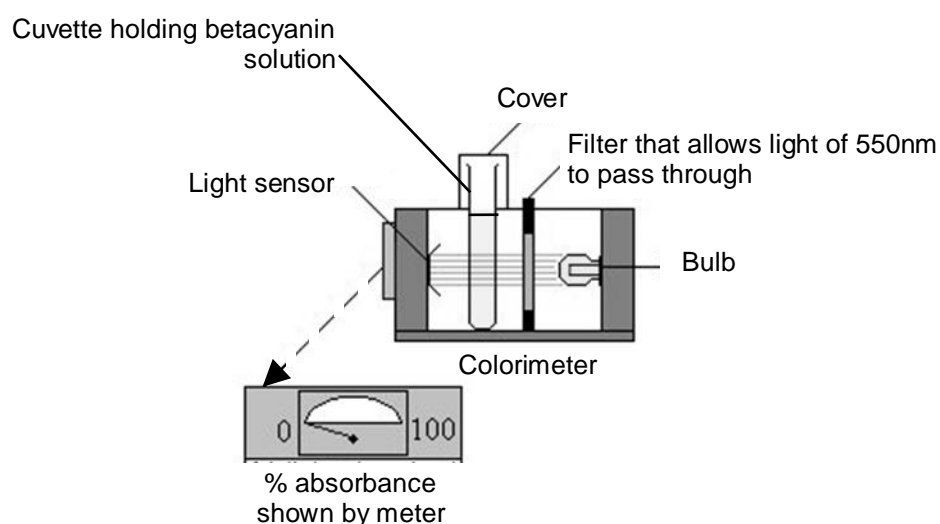

Fig. 4.1

Using the above information and your own knowledge, you are required to plan, but not carry out, an investigation into the effect of alcohol concentration on the permeability of the cell membrane of beetroot tissue.

Your planning must be based on the assumption that you have been provided with the following equipment and material which you must use.

- A large piece of beetroot tissue with the skin removed
- Sharp knife
- 10.0% Alcohol
- White tile
- Ruler
- Stopwatch
- Distilled water
- Colorimeter set at 550nm
- Cuvettes
- Normal laboratory glassware

Your plan should:

- have a clear and helpful structure such that the method you use can be repeated by anyone reading it,
- be illustrated by labelled diagrams, if necessary,
- identify independent and dependent variables,
- describe the method with scientific reasoning used to decide the method so that the results are as accurate and reliable as possible,
- include layout of results table(s) and graph(s) with clear headings and labels,
- use the correct technical and scientific terms,
- include reference to safety measures to minimize any risks associated with the proposed experiment.

[Total: 12]

.....

.....

.....

.....

.....

.....

.....

.....

.....

.....

.....

.....

.....

.....

.....

.....

.....

.....

.....

.....

.....

.....

.....

Free-response question

Write your answers to this question on the separate answer paper provided.

Your answer:

- should be illustrated by large, clearly labelled diagrams, where appropriate;
- must be in continuous prose, where appropriate;
- must be set out in sections **(a)**, **(b)** etc., as indicated in the question.

5.

- (a)** Describe cystic fibrosis and explain how it can be treated using a non-viral gene delivery system. [8]
- (b)** Discuss the advantages and limitations of plant tissue culture. [6]
- (c)** Discuss the ethical concerns pertaining to the use of genetically modified animals. [6]

[Total: 20]

End Of Paper

Candidate Name: _____

--	--

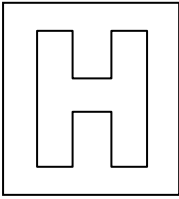

2016 Preliminary Examination II Pre-University 3

H2 Biology**9648/03****Applications Paper and Planning Question****22 September 2016****2 hours**

Additional Materials: Writing paper

READ THESE INSTRUCTIONS FIRST**Do not open this booklet until you are told to do so.**

Write your Admission number and name on all the work you hand in.
Write in dark blue or black pen on both sides of the paper.
You may use a HB pencil for any diagrams or graphs.
Do not use staples, paper clips, highlighters, glue or correction fluid.

Answer **all** questions.

The use of an approved scientific calculator is expected, where appropriate.
You will lose marks if you do not show your working or if you do not use appropriate units.
At the end of the examination, fasten all your work securely together.
The number of marks is given in brackets [] at the end of each question or part question.

For Examiner's Use	
1	
2	
3	
4	
5	
Total	

This question paper consists of 21 printed pages including 1 blank page

[Turn over

Answer **all** questions.

1. Before the emergence of more advanced technologies, cDNA libraries have been used to study the genetic changes involved in cancer development.

Normal and tumour cells are obtained from the same patient. Reverse transcription is carried out on mRNA isolated from the tumour cells. Primers consisting of thymine repeats were used during reverse transcription to form single-stranded cDNA as depicted in Figure 1.1. These cDNA are then labelled with fluorescent dyes.

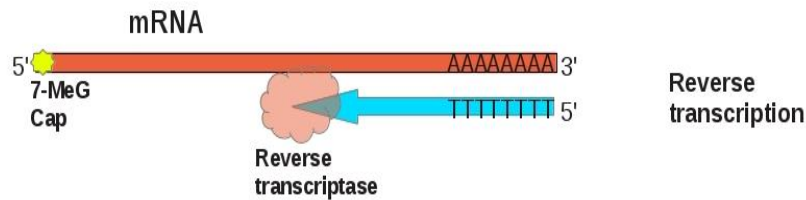

Figure 1.1

Normal cell mRNA and tumour cell cDNA are allowed to hybridise; the resulting double-stranded hybrid molecules and remaining single-stranded mRNA are discarded. Subtracted cDNA (also known as non-hybridized cDNA) are used to form a subtracted cDNA library. The process is summarized by Figure 1.2.

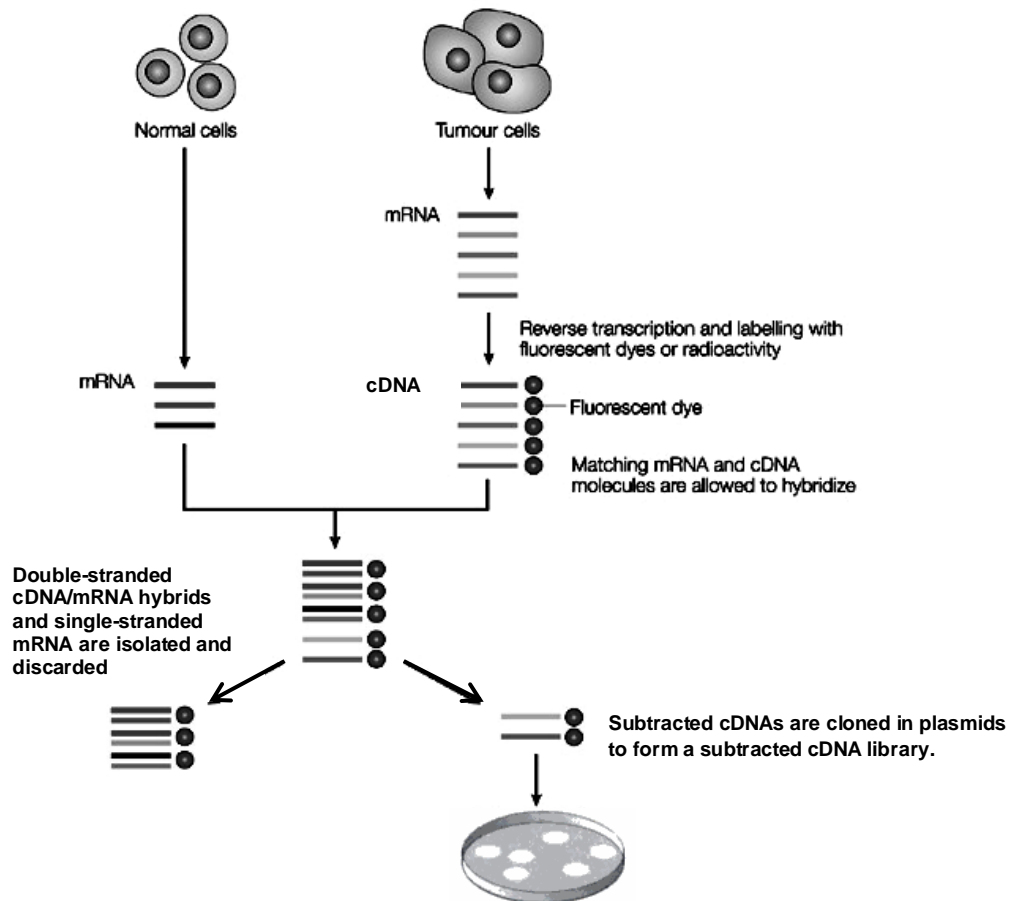

Figure 1.2

A young scientist conducting this procedure was concerned that possible presence of bacteria within cell samples might result in production of bacterial cDNA. This would contaminate downstream processes. However, her concerns were dismissed by her partners who assured her that reverse transcription of bacterial mRNA is unlikely to occur.

- (a) Using the information given, explain why reverse transcription of bacterial mRNA is unlikely to occur.

Bacterial mRNA do not possess a 3' poly(A) tail ;
This because bacteria does not carry out post-transcriptional modification to its mRNA.
Hence oligonucleotide primer is unlikely to anneal to bacterial mRNA for reverse transcription;
Max 2

[2]

- (b) Describe the steps needed to create recombinant DNA molecules that are used to assemble a plasmid library of subtracted cDNA.

Complementary strand of cDNA with respect to subtracted cDNA sequences are synthesized using DNA polymerase;
Linkers containing appropriate restriction sites are ligated to the double stranded cDNA;
cDNA and plasmids are cut/digest using the same restriction enzyme to produce complementary sticky ends;
Digested cDNA are ligated with digested plasmids;
During ligation digested cDNA and plasmids anneal with each other by complementary base pairing / Hydrogen bonding and are joined using DNA ligase which catalyses the formation of phosphodiester bonds;
Max 4

[4]

- (c) Explain why the DNA sequences in the subtracted cDNA library are considered mutant alleles implicated in cancer.

cDNA from tumour cells that hybridizes with mRNA from normal cells represent alleles that are expressed in both tumour and normal cells;
Alleles that are expressed in both tumour and normal cells may not be implicated in cancer;
Alleles that are expressed in both tumour and normal cells are removed by discarding double stranded cDNA/mRNA hybrids;
Subtracted cDNA derived from tumour cells represents the alleles that are expressed in tumour cells but not in normal cells;
Max 2

[2]

- (d) Suggest why the subtracted cDNA library may not fully capture all possible DNA sequences implicated in cancer.

Loss- of-function mutations in promotor sequence of tumour suppressor genes would not be captured by subtracted cDNA library;
Loss- of-function mutations in promotor sequence would inhibit gene expression;
AVP
Max 1;

[1]

Screening of the subtracted cDNA library of a cancer patient revealed a mutated protein kinase gene. A research team decided to clone this gene to isolate the mutant protein and study it to better understand its role in cancer development.

The protein kinase gene was first isolated. The artificial plasmid, pKY350, was constructed to act as an expression vector.

The plasmid was constructed to include two genes, each giving resistance to a different antibiotic: an ampicillin resistance gene and a tetracycline resistance gene. The plasmid also has a target site for the restriction enzyme, *Bam*HI, in the middle of the tetracycline resistance gene.

A pKY350 plasmid was cut using *Bam*HI and the cDNA sequence for the mutant protein kinase was inserted into it. Figure 1.3 shows pKY350 and the recombinant plasmid.

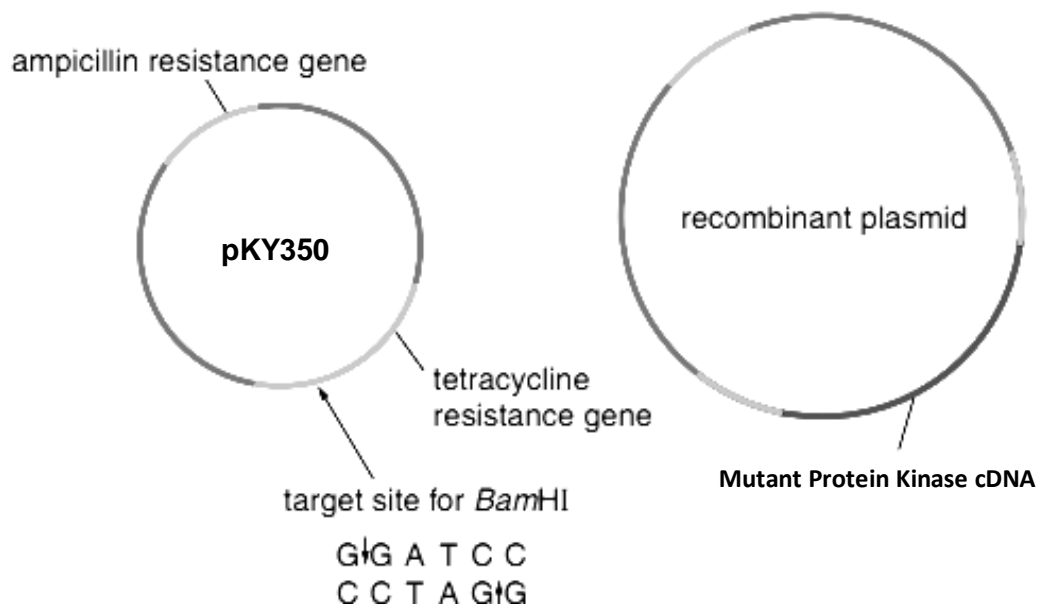

Figure 1.3

The mixture containing recombinant DNA was used to transform *E.coli* bacteria. Replica plating was used to identify recombinant bacteria with the mutant protein kinase gene. Figure 1.4 shows the bacterial colonies that grew on different nutrient agar plates.

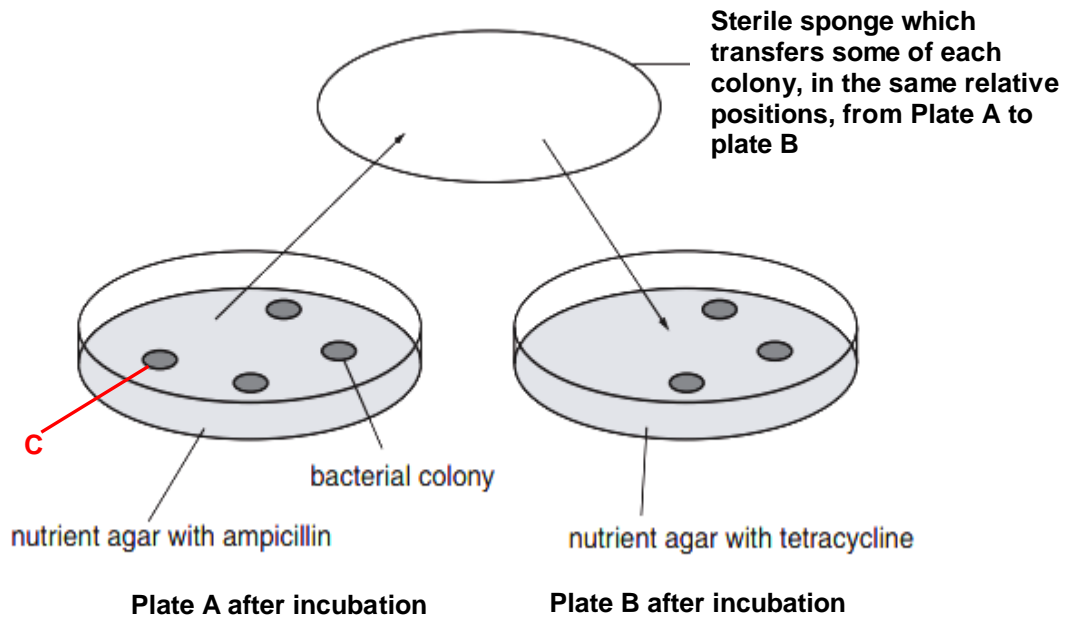

Figure 1.4

- (e) Use a label line and the letter C to identify, on Figure 1.4, a colony of bacteria that contain the recombinant plasmid.

[1]

A senior scientist declared that it would be a challenge to develop a good understanding of the role of the mutant protein kinase in cancer development from studying the recombinant protein produced by a bacterial cloning system.

- (f) Explain why recombinant mutant protein kinase produced by a bacterial cloning system may not be a good model of study for understanding cancer deve

..... Mutant tyrosine kinase synthesized in bacteria cells will not undergo post-translational modifications;
 Therefore the mutant protein may not have the same structure as it would adopt in normal cancer cells;
 Mutant protein kinase may function differently with a different structure which would undermine inferences about its role in cancer cells;
 Max 2m

[2]

Today, due to the findings of the human genome project, polymerase chain reaction (PCR) has largely replaced cDNA libraries to directly isolate genes in the study of diseases. PCR is normally carried out using the enzyme Taq DNA polymerase. This enzyme was originally extracted from the bacterium *Thermus aquaticus*. This bacterium was found in Mushroom Spring, one of the hot springs in Yellowstone National Park in the USA.

Taq DNA polymerase is now obtained from genetically modified *Escherichia coli* that carry the Taq DNA polymerase gene. The optimum temperature of this enzyme is 75-80°C.

After 40 minutes at 95°C, the activity of the enzyme is reduced by half. This means that the half-life of this enzyme at 95°C is 40 minutes.

- (g) Using your knowledge of PCR, explain why a half-life of 40 minutes at 95°C allows many cycles of PCR before the enzyme needs to be replaced.

Each cycle of PCR consists of the 3 stages of denaturation, annealing and extension;
Only the denaturation stage occurs at 95°C and annealing and extension occur at lower temperatures of 54°C and 72°C respectively;
Each cycle is completed within a short period of time which allows for many cycles of PCR to occur in 40min.
 Taq DNA polymerase has a high optimum temperature which results in a long half-life of 40 minutes;

Max 3

[3]

- (h) Suggest why Taq DNA polymerase is now obtained from genetically modified *E.coli*.

Cloning with *E.coli* allows for large scale production of Taq DNA polymerases;
 It is inconvenient to recover *Thermus aquaticus* to maintain constant supply of natural Taq DNA polymerases;
Thermus aquaticus is not easily cultured under laboratory conditions;

AVP
 Max 1

[2]

Work on the human genome project was able to provide many benefits to the field of molecular medicine.

- (i) State 2 other areas that have benefited from work on the human genome project.

Study of Microbial Genomics;
 Risk Assessment;
 Study of Bioarcheology, Anthropology, Evolution, and Human Migration;
 Genomic Mapping;
 Max 2

[2]

19]

2. Pluripotent stem cells are one type of stem cells and there is widespread interest in their study today. One key reason is because pluripotent stem cells can be induced to differentiate into the specific cell type required to repair damaged or destroyed cells or tissues. Additionally pluripotent stem cells can be used to study early events in human development and find out more about how cells differentiate and function. This may help researchers find out why some cells become cancerous and how some genetic diseases develop.

In 2006, a Japanese Scientist, Shinya Yamanaka, made a ground-breaking finding that would win him the Nobel Prize in Physiology or Medicine just six years later. He discovered that specialized cells can be stimulated to dedifferentiate and change back into pluripotent stem cells in tissue culture. Such cells are called induced pluripotent stem cells (iPS cells).

In experiments with mice, Yamanaka showed that the introduction of four genes caused specialized cells to change to iPS cells. Further studies have shown that these four genes indirectly result in the reprogramming of specialized cells by influencing the activity of many other genes.

- (a) Outline how the addition of the four genes may influence the activity of many other genes to result in the reprogramming of specialized cells into iPS cells.

The genes code for transcription factors / activators and repressors respectively/chromatin remodelling enzymes;
 These proteins mediate changes in gene expression to result in dedifferentiation into pluripotent stem cells;
 These proteins act to increases the expression of genes that control pluripotency of cells;
 These proteins act to decreases the expression of genes that resulted in differentiation of cells;
 Max 2

[2]

Pluripotent stem cells can also be derived from cytoplasmic hybrid (cybrid) cells through the method of somatic cell nuclear transfer (SCNT). A procedure for producing pluripotent stem cells by SCNT is outlined in Figure 2.1.

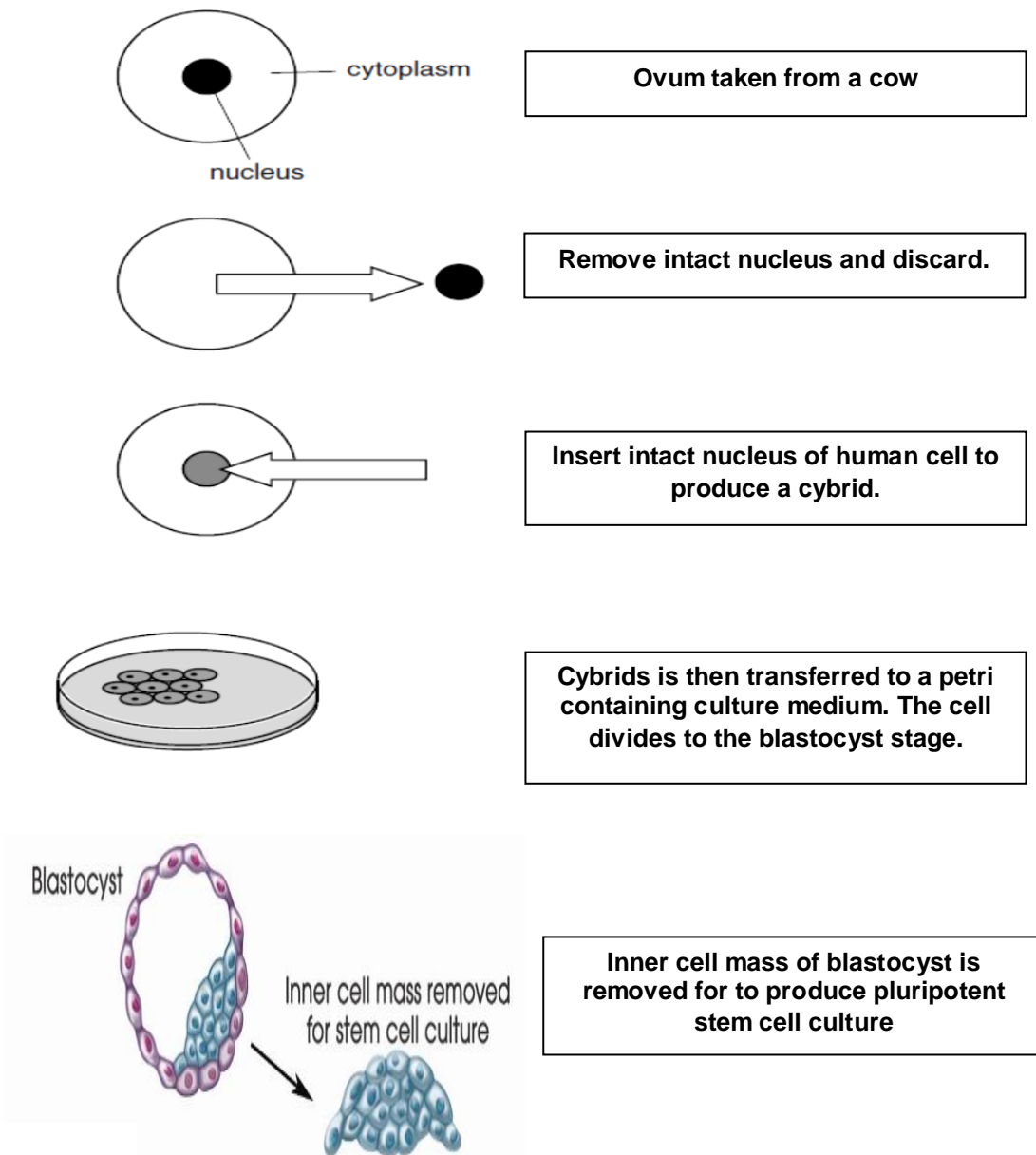

Figure 2.1

The DNA from the pluripotent stem cells generated by the above method is found to be 99.6% human.

(b) Explain the origins of the 0.04% cow DNA that is found in these cells.

Mitochondria from cow's ovum;
Binary division of mitochondria as cells divides account
for presence in descendent pluripotent cells;

[2]

Some people have argued that it is unethical to allow the production of cybrids.

(c) Suggest why the production of hybrids may be considered unethical.

In 2008
her own
were us
her tra
multipl

Presence of human and animal DNA means it is partly human and partly cow/ a human-animal hybrid which would not happen in nature;
Claims of the benefits of embryonic stem cell research are overrated/ few examples of success of using embryonic stem cells in medical field;
May lead to abuse of technology in future;
Unnecessary because, there already are alternative techniques to generate pluripotent stem cells such as by iPS technology;
Adult stem cells can be used to treat diseases;
AVP
Reject idea that human embryos will be destroyed

replace the damaged section of her bronchus. A month later the transplanted tissue had developed its own blood supply. This was claimed to be the first successful transplant using tissues derived from the patient's own stem cells.

(d) State two reasons why using the patient's own stem cells to treat a damaged bronchus is preferred to a transplant involving another donor.

.....
.....
.....
..... [2]

(e)

There will not be any immune response / tissue rejection since no foreign antigens, foreign tissue from the donated bronchus;
Overcomes the problem of finding and locating suitable donors;
No risk of infection arising from donor tissue / no need to decide who is eligible;
No need for immunosuppressant drugs to avoid rejection of transplanted organ;
Bronchus cells can be obtained / cultured in large quantities from the patient's stem cells;
Healthy culture of patient's stem cells can be stored for future needs;
AVP
Max 2

.....
..... [3]

Multipotent stems;
Partially differentiated;
Can differentiate further to produce cells within the same family;
Adult stem cells are self-renewing and can go through many rounds of cell division without differentiating;
AVP
Max 3

3. Iron-deficient anaemia is one of the most serious problems worldwide. Some scientists decided to explore the use of transgenic rice with increased copies of the Nicotianamine Synthase (NAS) gene to address the problem of iron deficiency. NAS is an enzyme in the metabolic pathway involved with iron acquisition in the rice plant. In these regards, the use of transgenic rice to address human iron deficiency is based on developing rice with increased iron content as transgenic rice would contain more copies of the NAS gene and produce more NAS enzymes compared to wild type rice.

To produce transgenic rice, a recombinant Ti plasmid containing NAS gene is engineered and reintroduced back into the bacteria *Agrobacterium tumefaciens*. The recombinant bacteria is then allowed to infect the plant. The process showing how transgenic rice plant is produced is illustrated in Figure 3.1.

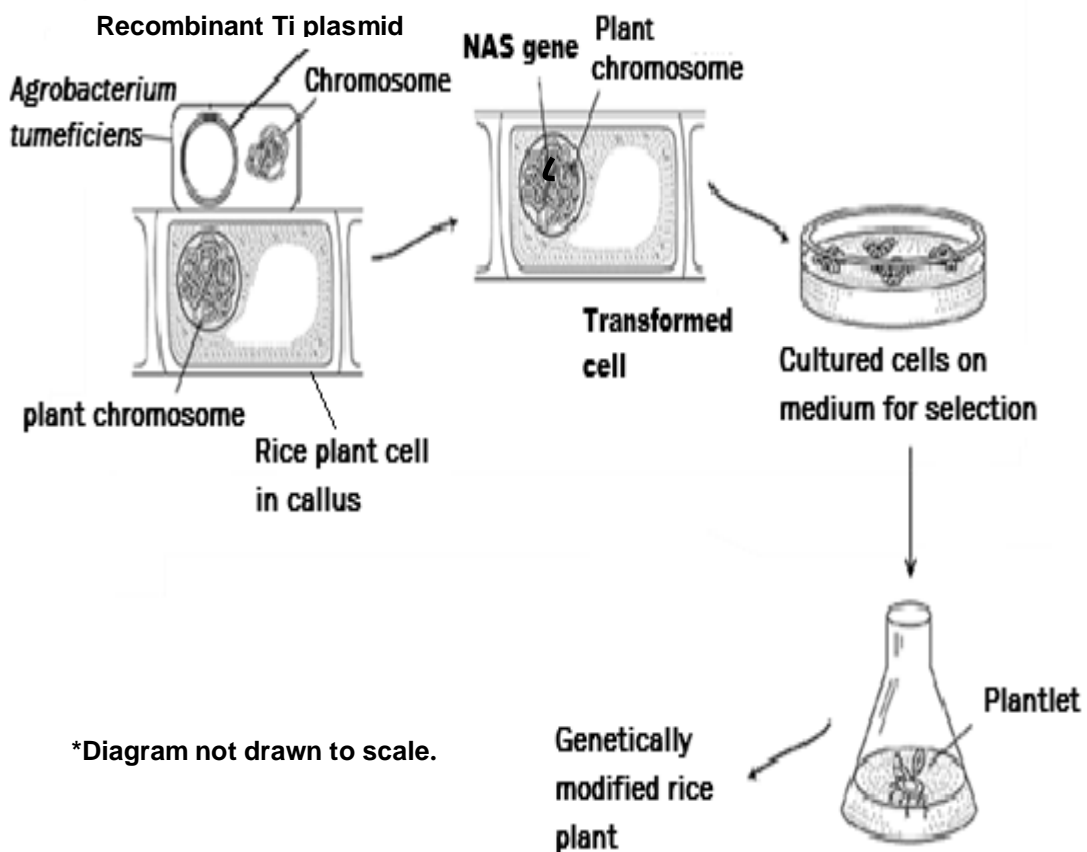

Figure 3.1

The naturally occurring Ti plasmid derived from *Agrobacterium tumefaciens*, is commonly used as a vector for introducing new foreign genes into plant cells. This plasmid integrates a segment of its DNA known as T-DNA, into the chromosomal DNA of host plant cells after infection. Figure 3.2 shows the structure of a natural Ti plasmid.

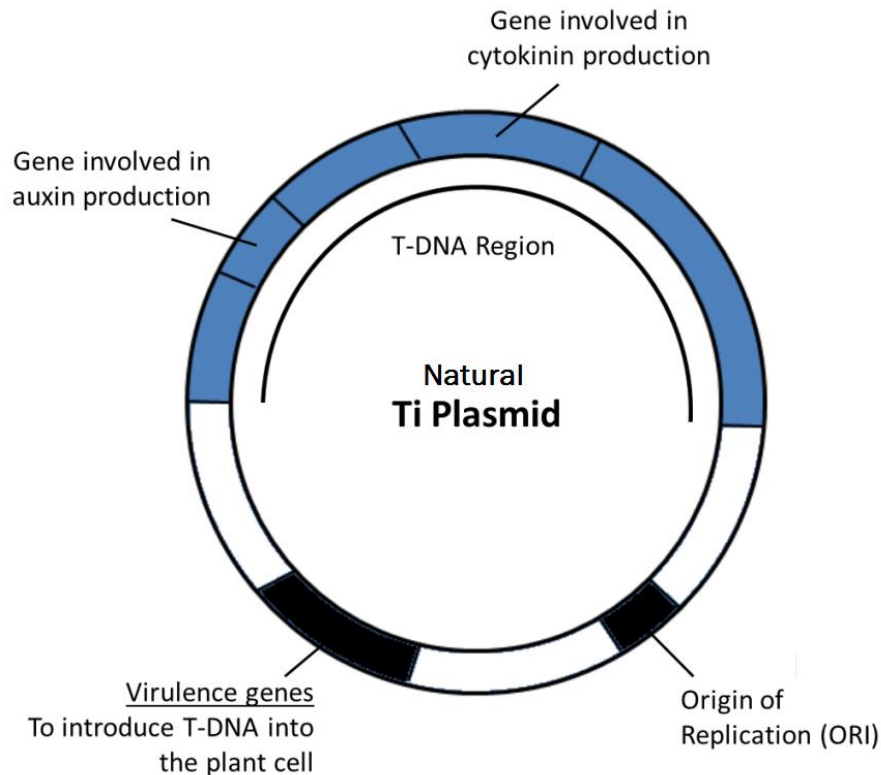

Figure 3.2

The genes for auxin and cytokinin are removed from the T-DNA region from the Ti plasmid before it can be used in the production of transgenic rice.

- (a) Explain why the genes for auxin and cytokinin are removed from the T-DNA region of the Ti Plasmid.

Auxins and cytokinins are plant growth hormones;
 These genes are expressed at high levels within the T-DNA region to promote tumour formation;
 Tumours will depress the yield of transgenic rice that can be harvested;
 Max 2

Transgenic rice plants have to undergo a process of acclimatization before they can be transferred to a natural environment for growth.

(b)

(i) Explain the importance of acclimatization.

Process of acclimatization allows plantlets to gradually get used to external uncontrolled conditions compared in vitro environment where they were previously grown in; Plantlets are chemoheterotrophs and require time to become photosynthetically competent;
Max 1

(ii) Describe a key step in this process.

Plantlets are first transplanted to sterile soil for further growth in a sheltered environment before they are replanted in an open uncontrolled environment.
Max 1

BLANK PAGE

A study was carried out to evaluate the efficacy of such transgenic rice with increased iron content. Twenty iron-deficient 12-year old girls were selected for the study. The haemoglobin count for each girl chosen was similarly below 12.8gdl^{-3} . The normal haemoglobin count for girls at the age of 12 is 12.8 to 16.0gdl^{-3} .

The girls selected for the study were randomly and equally sorted into a treatment group and control group. The girls in the treatment group were requested to adhere to a diet of transgenic rice with increased iron content, three times a day, for 5 months. The girls in the control group were requested to adhere to a diet of normal rice grown in the same rice field, three times a day, for 5 months. The mean haemoglobin count for each group was tracked over this period.

The results of the analysis are shown in Figure 3.3.

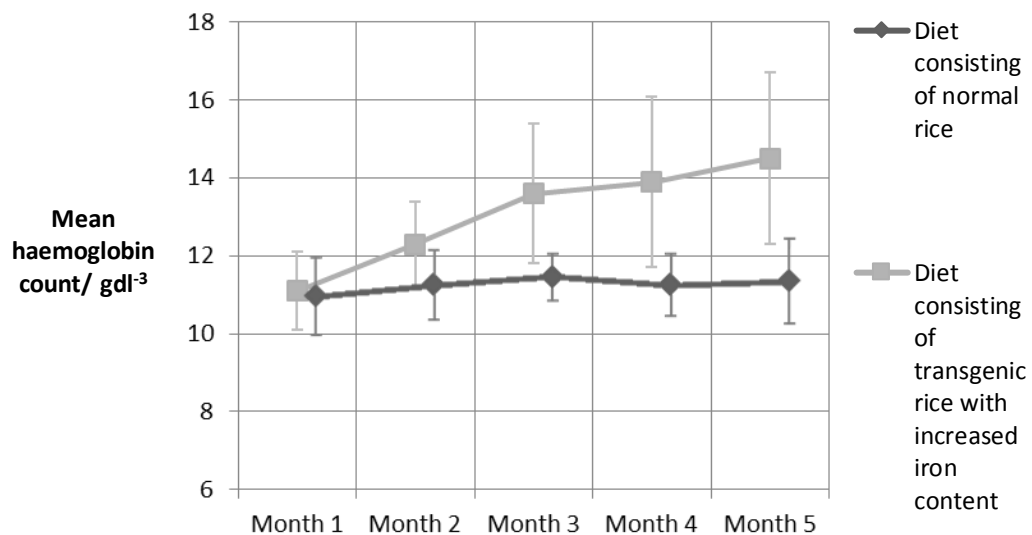

Figure 3.3

At the end of the study, the scientists involved concluded that the transgenic rice was more effective than normal rice in helping iron-deficient children.

(c) With reference to Figure 3.3, discuss the validity of this conclusion.

The conclusion is not valid;
 The error bars for the mean haemoglobin count from transgenic rice diet indicate there is large/wide variation among the subjects studied;
 This is exemplified by 11.5 to 16gdl^{-3} for 4th month and 12.5 to 17gdl^{-3} for 5th month
 Therefore even though there seems a rise in mean haemoglobin count from transgenic diet compared to normal rice diet the difference in mean haemoglobin count between both diets is not considered significant;
 The sample size/ the number of people studied is also too small to justify this conclusion;
 Max 3m

In addition to producing more nutritious food, genetically engineered crops like Bt corn can also be used in solving the world demand for food.

(d) Explain how Bt corn helps solve the global food challenge.

.....

Bt gene codes for a large crystal-like protein known as the Bt toxin;
The toxin is ingested by target insect pests when they feed on transgenic corn;
The toxin binds to the specific receptors on the cell membranes of insect gut epithelial cells and causes them to be permeable;
The toxin therefore causes gut cells of insect to lyse, eventually leading to the death of the insects;
Bt toxin is not known to have any harmful effects on humans as the acid in our stomach will denature the protein;
Bt crop therefore increases yield of crops by reducing damage caused by insect pests;
Max4

..... [4]

[Total: 11]

4. Beetroot is a starchy edible root from the *Beta vulgaris* plant whose cells contain a water-soluble red pigment, betacyanin, in their vacuoles. Beet root pigment is used commercially as a food dye and different methods have been used to extract the pigment from intact beetroot cells. This pigment cannot pass through membranes unless the membranes are damaged.

A colorimeter can be used to measure the absorbance of light at 550 nm by betacyanin solution. The concentration of betacyanin is proportional to its absorbance. The use of a colorimeter to measure absorbance by betacyanin is depicted in Figure 4.1.

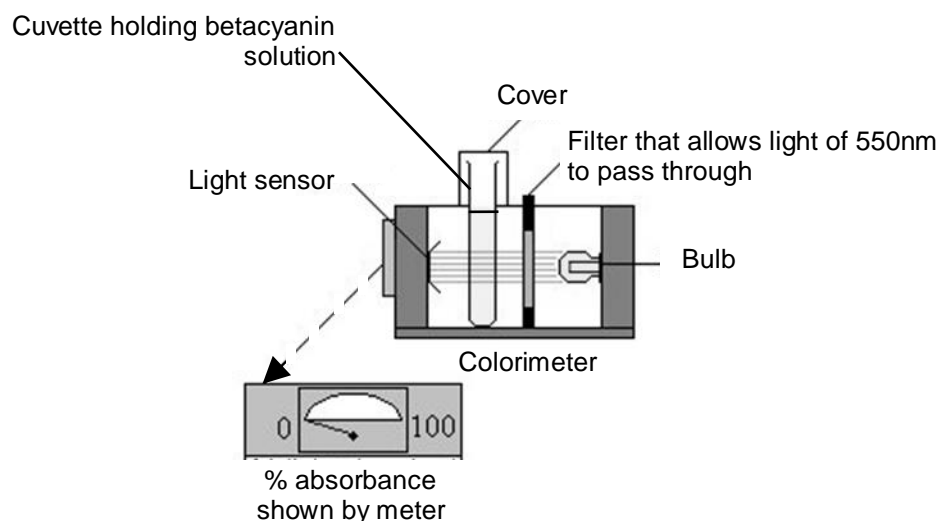

Fig. 4.1

Using the above information and your own knowledge, you are required to plan, but not carry out, an investigation into the effect of alcohol concentration on the permeability of the cell membrane of beetroot tissue.

Your planning must be based on the assumption that you have been provided with the following equipment and material which you must use.

- A large piece of beetroot tissue with the skin removed
- Sharp knife
- 10.0% Alcohol
- White tile
- Ruler
- Stopwatch
- Distilled water
- Colorimeter set at 550nm
- Cuvettes
- Normal laboratory glassware

Your plan should:

- have a clear and helpful structure such that the method you use can be repeated by anyone reading it,
- be illustrated by labelled diagrams, if necessary,
- identify independent and dependent variables,
- describe the method with scientific reasoning used to decide the method so that the results are as accurate and reliable as possible,
- include layout of results table(s) and graph(s) with clear headings and labels,
- use the correct technical and scientific terms,
- include reference to safety measures to minimize any risks associated with the proposed experiment.

[Total: 12]

Section	Mark Scheme	Max marks																												
T	<p>T1. Betacyanin pigment is large/ hydrophilic and cannot pass through hydrophobic core of phospholipid bilayer;</p> <p>T2. Increasing alcohol concentration increases damage/disruption to the integrity of cell membrane/regular arrangement of the membrane;</p> <p>T3. This is due to solubilisation of phospholipids/alcohol dissolving phospholipids;</p> <p>T4. Vacuole membrane/tonoplast AND cell surface membrane lose selective permeability/become more permeable, allowing pigment to diffuse out of the cell;</p> <p>T5. As concentration of alcohol increases, membrane permeability of beetroot tissue increases, leading to an increase in absorbance value;</p> <p>T6. The independent variable in this experiment is alcohol concentration while the dependent variable is absorbance at 550nm;</p> <p>T7. Other variables to be kept constant (any 2);</p> <p>-washing and rinsing cut beetroot cylinders before start of experiment.</p> <p>-calibration of colorimeter using alcohol solution;</p> <p>- Dimensions of beetroot tissue used (if using scalpel).</p> <p>-Time the beetroot cubes were immersed in the alcohol solution.</p> <p>-Same volume of alcohol used (e.g. 10-15cm³)</p> <p>-Same cuvette used</p> <p>-Same beetroot used</p> <p>-Constant temperature (e.g. 28°C -30°C)</p>	<p>Max 2 marks</p> <p>Max 1 mark</p>																												
M	<p>1. Prepare 10 cm³ each of 2.0%, 4.0%, 6.0%, 8.0% and 10.0% alcohol solution and control by diluting the 10.0% stock alcohol solution and place them in labelled test tubes;</p> <table border="1" data-bbox="327 1697 1201 2033"> <thead> <tr> <th>Test tubes</th> <th>Concentration of alcohol solution/%</th> <th>Volume of 10% alcohol/cm³</th> <th>Volume of distilled water/cm³</th> </tr> </thead> <tbody> <tr> <td>A</td> <td>2.0</td> <td>2.0</td> <td>8.0</td> </tr> <tr> <td>B</td> <td>4.0</td> <td>4.0</td> <td>6.0</td> </tr> <tr> <td>C</td> <td>6.0</td> <td>6.0</td> <td>4.0</td> </tr> <tr> <td>D</td> <td>8.0</td> <td>8.0</td> <td>2.0</td> </tr> <tr> <td>E</td> <td>10.0</td> <td>10.0</td> <td>0.0</td> </tr> <tr> <td>Control</td> <td>0.0</td> <td>0.0</td> <td>10.0</td> </tr> </tbody> </table> <p>1m for completed dilution table;</p>	Test tubes	Concentration of alcohol solution/%	Volume of 10% alcohol/cm ³	Volume of distilled water/cm ³	A	2.0	2.0	8.0	B	4.0	4.0	6.0	C	6.0	6.0	4.0	D	8.0	8.0	2.0	E	10.0	10.0	0.0	Control	0.0	0.0	10.0	6 marks max
Test tubes	Concentration of alcohol solution/%	Volume of 10% alcohol/cm ³	Volume of distilled water/cm ³																											
A	2.0	2.0	8.0																											
B	4.0	4.0	6.0																											
C	6.0	6.0	4.0																											
D	8.0	8.0	2.0																											
E	10.0	10.0	0.0																											
Control	0.0	0.0	10.0																											

2. Cut the beetroot tissue into cubes of 1cm³ (Or identical dimensions) on a white tile using a ruler and scalpel;
3. Wash and rinse beetroot cubes in distilled water to remove any pigments which may leak out during cutting. There should be no further leakage of colour from the beetroot tissue;
4. Place 5 beetroot cubes into a test tube A;
5. Immediately start timing for 5 minutes using a stopwatch;
6. After 5 minutes, remove 1 cm³ of extract from test tube A and transfer to a cuvette;
7. Measure absorbance value at 550nm using colorimeter;
8. Repeat steps 4-7 for 4%, 6%, 8%, 10% alcohol solutions and control;
9. Before measuring absorbance, colorimeter should be calibrated with matching concentration of alcohol solution with respect to each sample;
10. Perform 2 more replicates for each concentration of alcohol solution to obtain average absorbance + repeat entire experiment twice with fresh batch of reagents to ensure reproducibility;

Test tube containing 5 1cm³ beet root cubes in alcohol solution

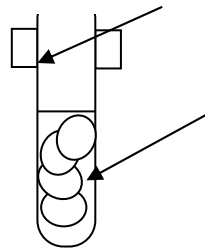

Extract is removed after 5 minutes of incubation and transferred to cuvette to measure absorbance at 550nm by colorimeter

1m for labelled diagram;

R

R1. Table with correct headings with appropriate units + Replicate and average included;

2 marks max

Concentration of alcohol solution/%	Absorbance / A.U			
	Replicate 1	Replicate 2	Replicate 3	Average
2.0				
4.0				
6.0				
8.0				
10.0				
0.0				

R2. Graph showing x-axis: Alcohol concentration A, y-axis: average absorbance / A.U;

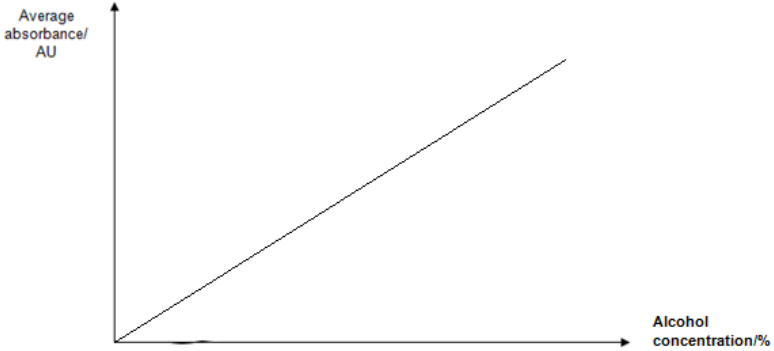
		
S	<p>S1. Handle scalpel <u>carefully</u> or place them <u>away from main work area after use to avoid injuring/cutting oneself</u>;</p> <p>S2. Handle liquid chemicals such as the 10% alcohol <u>with care</u> or wear <u>protective goggles</u> to prevent <u>eyes from being in contact with alcohol</u>;</p> <p>S3. Handle fragile objects like test tubes <u>with care</u>. Arrange test tubes neatly in the test tube rack, ensuring that they are placed where they cannot be knocked over or roll off the bench to <u>prevent breakage</u>;</p>	1 mark max

Free-response question

Write your answers to this question on the separate answer paper provided.

Your answer:

- should be illustrated by large, clearly labelled diagrams, where appropriate;
- must be in continuous prose, where appropriate;
- must be set out in sections **(a)**, **(b)** etc., as indicated in the question.

5.

- (a)** Describe cystic fibrosis and explain how it can be treated using a non-viral gene delivery system. [8]
- (b)** Discuss the advantages and limitations of plant tissue culture. [6]
- (c)** Discuss the ethical concerns pertaining to the use of genetically modified animals. [6]

[Total: 20]

End of Paper

1.
(a) Describe cystic fibrosis and how it can be treated using a non-viral gene delivery system [8]

Description of cystic fibrosis:

Cystic fibrosis (CF) is an autosomal recessive disease;

Caused by mutation of cystic fibrosis transmembrane conductance regulator gene;

The CFTR protein is a chloride channel which regulates the transport of chloride ions across epithelial cells;

Mutations in the CFTR gene disrupt the function of the chloride channels, preventing them from regulating the flow of chloride ions and water across cell membranes;

The most common mutation is a deletion of three nucleotides on chromosome 7 that results in a loss of the amino acid phenylalanine (F) at the 508th (508) position on the protein;

As a result, cells that line the passageways of the lungs, pancreas, and other organs produce mucus that is unusually thick and sticky;

This abnormal mucus can clog the airways, leading to severe problems with breathing and bacterial infections in the lungs;

Over time, mucus build-up and infections result in permanent lung damage, including the formation of scar tissue (fibrosis) and cysts in the lungs;

A build-up of thick, sticky mucus in the pancreas can block the pancreatic duct from secreting digestive enzymes and importance hormones (e.g. insulin);

Problems with digestion can lead to diarrhoea, malnutrition, poor growth, and weight loss;

AVP

Max 4

Treatment of cystic fibrosis:

A normal functioning CFTR gene is isolated;

The allele is cloned many times by PCR;

The allele is then encapsulated into liposomes;

Liposomes are then delivered to epithelial cell in the lung by aerosol spray (nasal spray);

The gene particles are inhaled, so that they can pass into the epithelial cells of the lung to be incorporated into the DNA of the cells;

The liposome fuses with the plasma membrane of the epithelial cell lining the lung and releases the DNA into the cell;

The normal CFTR enters nucleus and is transcribed and translated to produce normal CFTR protein which can be incorporated into plasma membrane to facilitate the transport of chloride;

AVP

Max 4

(b) Discuss the advantages and limitations of plant tissue culture. [6]

Advantages

Rate of growth by micro-propagation is also greater than conventional propagation;

The genetic makeup of all plants possessing desirable phenotypes can be preserved generation after generation;

Possible to produce clones of some plants species that are otherwise difficult or slow to propagate by conventional means (e.g. orchid);

Able to multiply plants which produce little or no seeds (e.g. bananas);

Production of disease free plants when explants are taken from meristematic regions (shoot tips, root tips), which are free from viruses;

Production of new plants can be continued all year round and is independent of seasonal/climate changes;

Relatively low space requirement, as compared to growing plants in greenhouses or farms;

Max 3

Disadvantages

The limited gene pool and genetic uniformity of plants cultured make them vulnerable to new diseases or drastic changes in the environment;

Very expensive due to several factors due to high overhead (specialized equipment, facilities, supplies) and labour costs;

It is also labour intensive as labour is required to transfer plantlets from laboratory to soil. Therefore this may not be economical for crops with low financial returns like carrots;

Plants produced from calli may undergo genetic changes to produce genetic variations, which usually result in undesirable phenotypes;

Max 3

(c) Discuss the ethical concerns pertaining to the use of genetically modified animals. [6]

Genetically modifying organisms will mean tampering with nature and hence going against the natural way of life;

There is concern about whether the animals are biologically capable of withstanding the additional stress of increased production of milk, meat and other products;

Increased use of growth hormone has harmful effects on the health of animals;

The use of bovine somatotropin in dairy cattle increases the risk of mastitis, which is a disease of the udder;

Medical experiments may cause suffering in animals;

For example, oncogenes are cloned into mice to study cancer. These transgenic mice develop tumours more frequently than normal ones and suffer the symptoms of cancer development;

In US, there is no mandatory labelling of GM food or GM processed food;

This may pose health risks as the consumer may have an unwanted reaction towards these products;

Some religions and ethnic groups avoid eating certain foods, but the food they eat might contain genes from other sources which they must not eat;

The concern rises from the belief that consumers should have right to know and choose what they are purchasing and consuming;

There is fear that cloning techniques (e.g. those used in the cloning of Dolly the sheep in 1997) may be used on humans, to create beings with desirable qualities race/ used to eventually practice eugenics;

[Total: 20]